



- EN For more information see www.govizu.com
- NL Voor meer informatie zie www.govizu.com
- DE Für weitere Informationen siehe www.govizu.com
- FR Pour plus d'informations, veuillez consulter le site www.govizu.com
- ES Para más información, visite www.govizu.com
- DA For mere information besøg www.govizu.com
- FI Lisätietoja löydät osoitteesta www.govizu.com



1 Check the contents

Controleer de inhoud
Kontrollieren Sie den Inhalt
Vérifiez le contenu
Revise el contenido
Kontroller indholdet
Tarkista sisältö

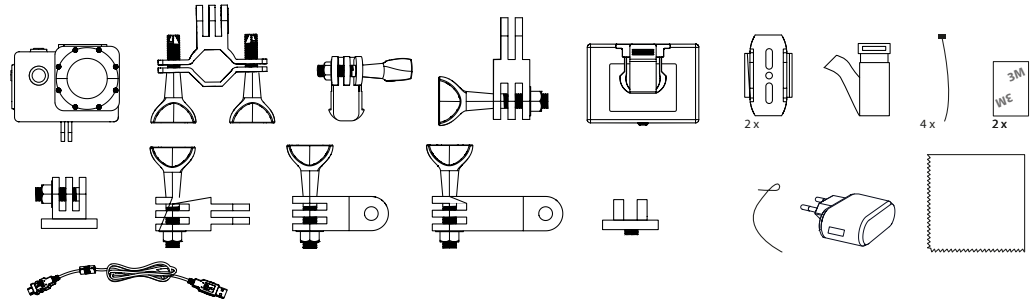

2 Charge the appliance

Het apparaat laden
Gerät laden
Charger l'appareil
Cargar el dispositivo
Lad apparatet op
Lataa laite

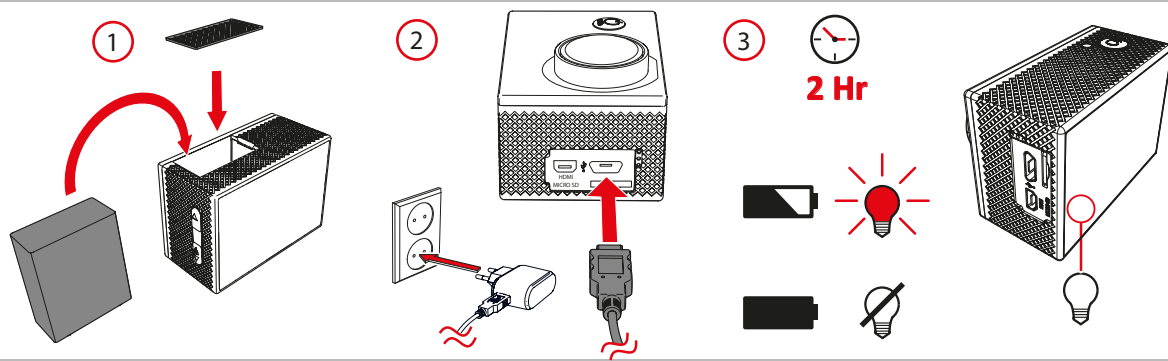

3 Slot-in for micro SD card

Micro SD-kaart ingang
Anschluss für Micro-SD-Karte
Connecteur pour carte micro mémoire flash
Entrada para tarjeta micro SD
Slids til micro SD
Micro SD-korttipaikka

Max. 64 GB

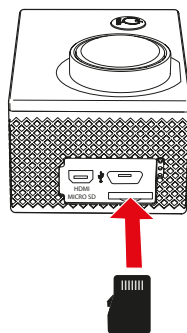

4 Functions

Functies
Funktionen
Fonctions
Funciones
Funktioner
Toiminnot

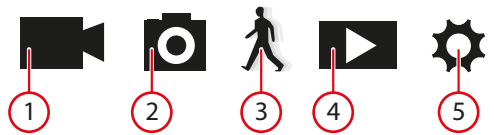

1	Film	4	Play
2	Photo	5	Settings
3	Slow filming		

5 Main parts

Belangrijkste onderdelen
Hauptkomponenten
Pièces principales
Partes principales
Hoveddele
Pääosat

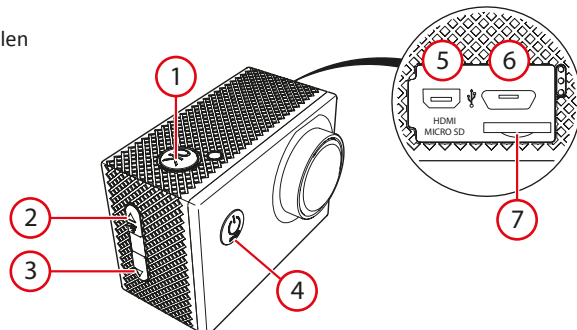

1	OK	5	HDMI
2	◀ / WIFI / UP	6	USB port 2.0
3	▶ / DOWN	7	MICRO SD CARD
4	ON / OFF / MODE		

6 Turn the appliance on/off

Het apparaat aan en uit zetten
Das Gerät an- und ausschalten
Mettre l'appareil en service/hors service
Encender/apague el aparato
Tænd/sluk apparatet
Kytke laite päälle/pois päältä

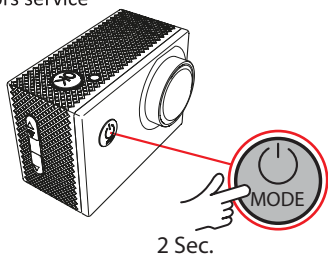

7 Start filming

Beginnen met filmen
Videoaufnahme starten
Démarrer la vidéo
Comenzar a grabar
Start med at filme
Aloita kuvaus

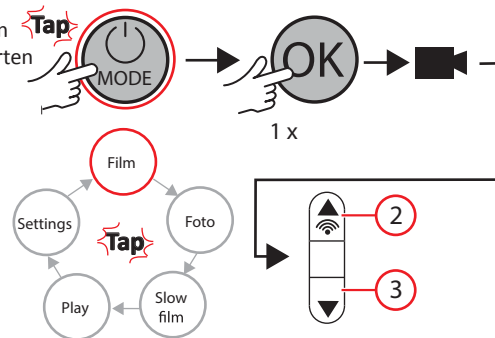

8 Make a photo

Een foto maken
Ein Foto machen
Prendre une photo
Tomar una fotografía
Tag et foto
Ota kuva

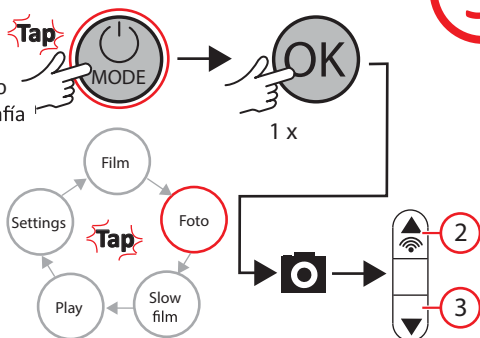

9 Start slow filming

Beginnen met langzaam filmen
Zeitlupe-Videoaufnahme starten
Démarrer une vidéo lente
Iniciar grabación lenta
Start med at filme langsom
Aloita hidastettu kuvaus

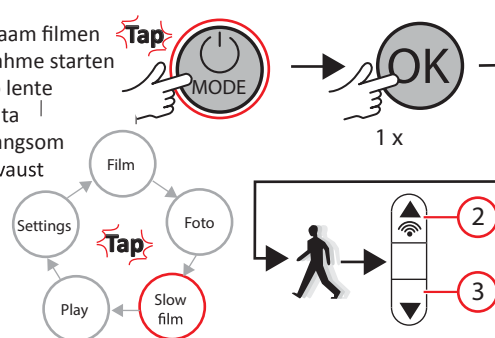

10 Play

Afspelen
Wiedergabe
Lecture
Reproducir
Afspil
Toista

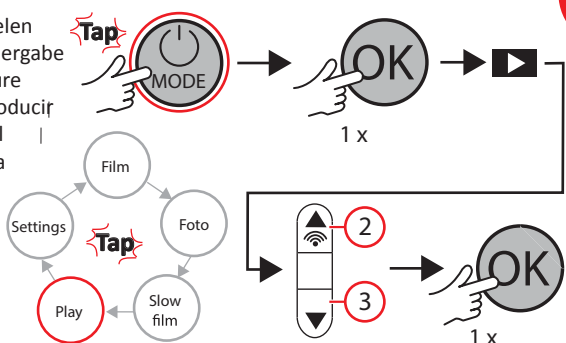

11 Settings

Instellingen
Einstellungen
Paramètres
Ajustes
Indstillinger
Asetukset

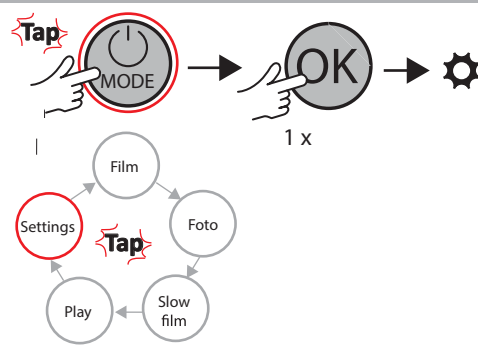

12 Make a WIFI connection

Een WIFI verbinding maken
Eine WLAN-Verbindung herstellen
Faire une connexion WIFI
Realizar una conexión WIFI
Opret en WIFI-forbindelse
Muodosta Wi-Fi-yhteys

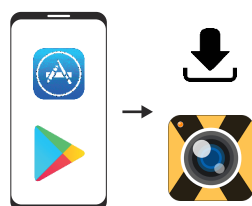

Download: XDV App



Activate wifi

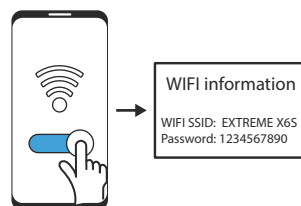

WiFi information
WiFi SSID: EXTREME X6S
Password: 1234567890

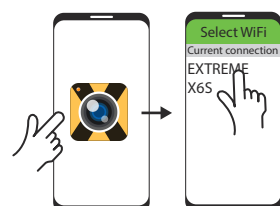

Open app and select actioncam

Specifications

Specificaties

Technische Daten

Spécifications

Especificaciones

Specifikationer

Tekniset tiedot

Model number: EXTREMEX6S DSP: V3	Model nummer: EXTREMEX6S DSP: V3	Modellnummer: EXTREMEX6S DSP: V3	Numéro de modèle: EXTREMEX6S DSP: V3	Número de modelo: EXTREMEX6S DSP: V3	Modelnummer: EXTREMEX6S DSP: V3	Mallinnumero: EXTREMEX6S DSP: V3
Image Format: JPEG Video Format: MP4	Formaat foto: JPEG Formaat video: MP4	Bildformat: JPEG Videoformat: MP4	Format d'image: JPEG Format vidéo: MP4	Formato de imagen: JPEG Formato de video: MP4	Billedformat: JPG Videoformat: MP4	Kuvamuoto: JPEG Videomuoto: MP4
Charging Time: +- 2 hours Size: 59 x 41 x 29mm Weight: 44gr (without batteries), 58gr with batteries	Laadtijd: +- 2 hours Afmetingen: 59 x 41 x 29mm Gewicht: 44gr (zonder batterijen), 58gr met batterijen	Ladezeit: +- 2 Stunden Abmessungen: 59 x 41 x 29 mm Gewicht: 44 g (ohne Akku), 58 g mit Akku	Durée de recharge : +- 2 heures Dimensions : 59 x 41 x 29 mm Poids : 44 g (sans batteries), 58 g avec batteries	Tiempo de carga: +- 2 horas Tamaño: 59 x 41 x 29 mm Peso: 44 g (sin pilas), 58 g con pilas	Ladetid: +- 2 timer Størrelse: 59 x 41 x 29mm Vægt: 44 gr (uden batterier), 58 gr med batterier	Latausaika: +- 2 tuntia Koko: 59 x 41 x 29 mm Paino: 44 g (ilman akkuja), 58 g akkujen kanssa
Waterproof in case	Waterbestendig in de behuizing	Wasserdicht im Gehäuse	Étanche dans le logement	Sumergible en el viviendas	Vandtæt i boliger	Vedenpitävä ett kotelo