

Quickstart guide

NPRD58BK
Portable boombox

NIKKEI



- EN For more information see the extended manual at www.nikkei.eu
- NL Voor meer informatie zie de uitgebreide handleiding op www.nikkei.eu
- DE Für weitere Informationen siehe das umfassende Handbuch unter www.nikkei.eu
- FR Pour plus d'informations, voir le manuel détaillé sur www.nikkei.eu
- ES Para más información, consulte el manual ampliado en www.nikkei.eu
- IT Per ulteriori informazioni consultare il manuale completo su www.nikkei.eu



1 Main parts

Hoofd onderdelen
Hauptteile
Parties principales
Partes principales
Parti principali

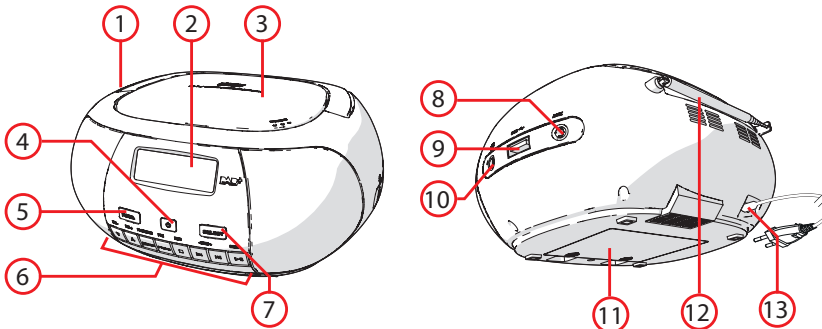

1	Handle
2	LCD display
3	CD door
4	Standby
5	Function/mode
6	Control buttons
7	Select
8	3.5mm aux-in jack
9	USB port
10	3.5mm headphone jack
11	Battery compartment
12	Antenna
13	AC socket

2 Connect to the mains

Sluit op het lichtnet aan
Schließen Sie die Netzspannung an
Raccordez au réseau électrique
Conecte a la red eléctrica
Collegare alla rete elettrica

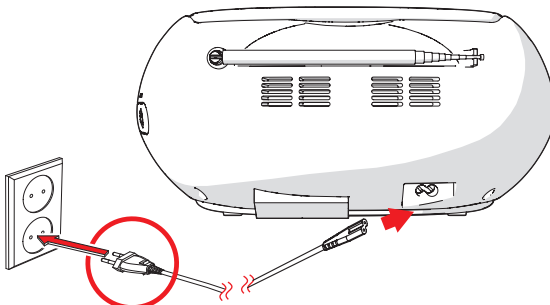

OR place batteries

Of
Oder
Ou
O
O

Plaats de batterijen
Legen Sie die Batterien ein
Placez les piles
Coloque las pilas
posizionare le batterie



3 Turn on the device

Schakel het apparaat in
Schalten Sie das Gerät ein
Mettez l'appareil en marche
Encienda el aparato
Accendi il dispositivo



4 Function button

De FUNC. toets
Die FUNC. Taste
La FUNC. touche
Los FUNC. botones
Il FUNC. pulsante

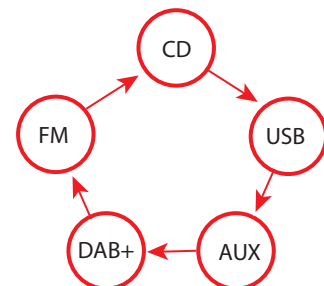

5 Slide out the antenna

Schuif de antenne uit
Antenne ausziehen
Dépliez l'antenne
Extienda la antena
Sfilare l'antenna

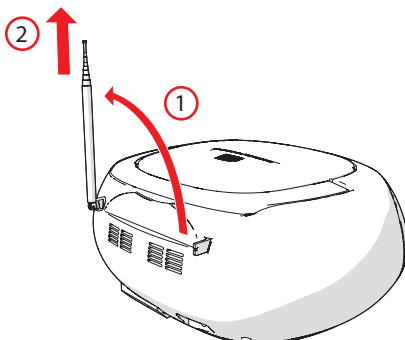

6 Select radio frequency

Kies frequentie
Wählen Sie die Frequenz
Sélectionnez la fréquence
Elija la emisora
Seleziona la frequenza

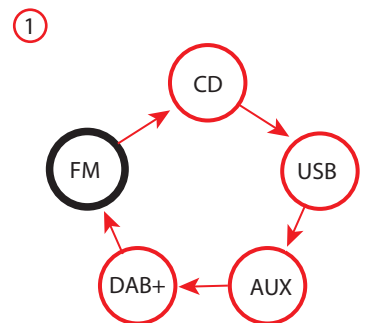
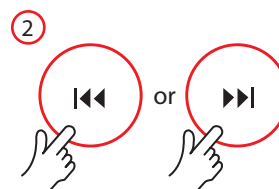

7

DAB+ functions

DAB+ functies
DAB+-Funktionen
Fonctions DAB+
Funciones del DAB+
DAB+ funzioni

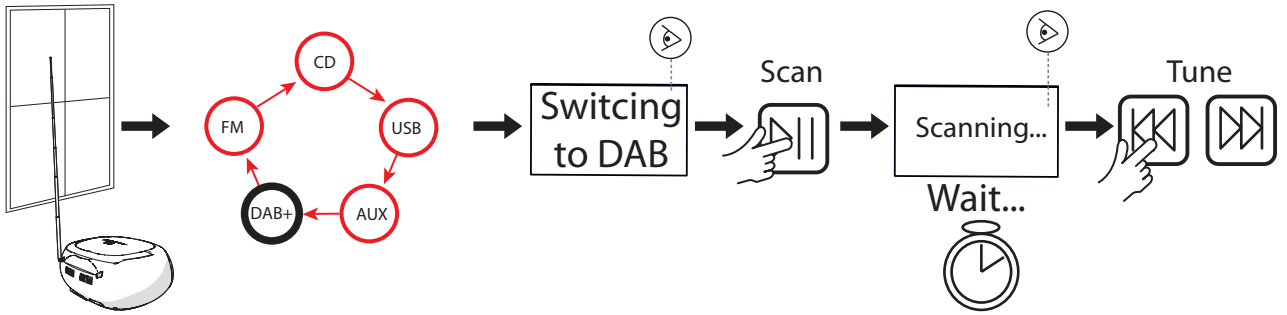

8

USB slot

USB aansluiting
USB Anschluss
Port USB
Conexión USB
Connessione USB

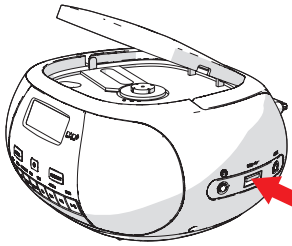
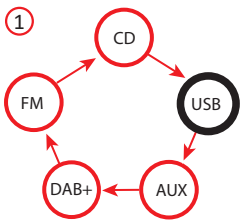

9

CD functions

CD functies
CD-Funktionen
Fonctions CD+
Funciones del CD+
CD+ funzioni

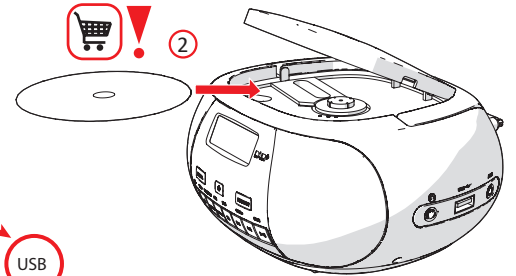
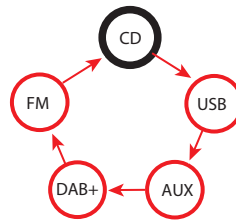

10

LINE IN connection

LINE IN aansluiting
Buchse LINE IN
Connexion LINE IN
Conexión LINE IN
Connessione LINE IN

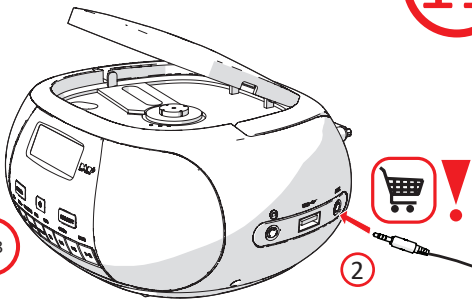
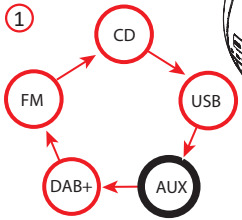

11

Turn off the device

Schakel het apparaat uit
Schalten Sie das Gerät aus
Éteindre l'appareil
Apagar el dispositivo
Spegni il dispositivo



12

Setting the time

Tijd instellen
Zeit einstellen
Régler l'heure
Configuración del tiempo
Impostazione dell'ora

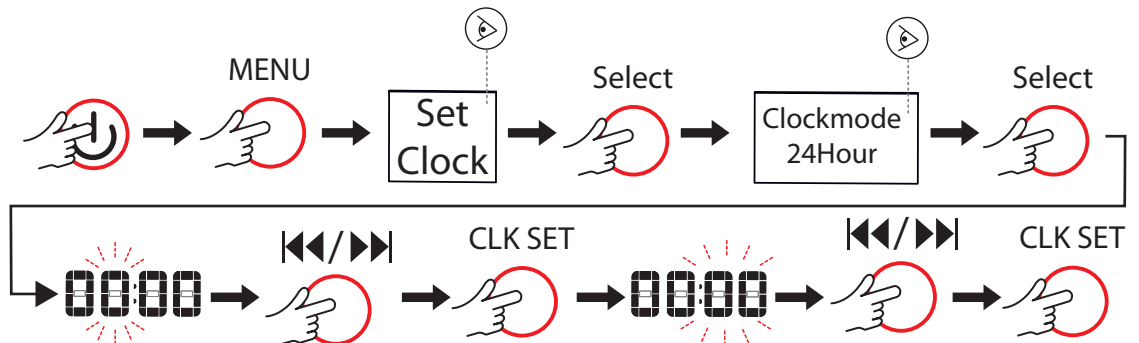

Specifications	Specificaties	Technische Daten	Spécifications	Especificaciones	Specificazioni
Dimensions: 227 x 208 x 125 mm Speakers: 2 x 1 Watt (Stereo) Power: AC 220-240 V, 50-60 Hz Media playing formats: CD-R, CD-RW, CD, MP3, DAB+, FM, Headphone input, AUX-in, USB	Dimensies: 227 x 208 x 125 mm Speakers: 2 x 1 Watt (Stereo) Vermogen: AC 220-240 V, 50-60 Hz Mediaformaten: CD-R, CD-RW, CD, MP3, DAB+, FM, Headphone input, AUX-in, USB	Maße: 227 x 208 x 125 mm Lautsprecher: 2 x 1 Watt (Stereo) Leistung: AC 220-240 V, 50-60 Hz Medienwiedergabeformate: CD-R, CD-RW, CD, MP3, DAB+, FM, Headphone input, AUX-in, USB	Dimensions: 227 x 208 x 125 mm Puissance de sortie: 2 x 1 Watt (Stéréo) Puissance: AC 220-240 V, 50-60 Hz Formats de lecture des supports: CD-R, CD-RW, CD, MP3, DAB+, FM, Headphone input, AUX-in, USB	Dimensiones: 227 x 208 x 125 mm Potencia de salida: 2 x 1 vatios (estéreo) Potencia: AC 220-240 V, 50-60 Hz Formatos de reproducción de medios: CD-R, CD-RW, CD, MP3, DAB+, FM, Headphone input, AUX-in, USB	Dimensioni: 227 x 208 x 125 mm Potenza in uscita: 2 x 1 Watt RMS (Stereo) Potenza: AC 220-240 V, 50-60 Hz Formati di riproduzione multimediale: CD-R, CD-RW, CD, MP3, DAB+, FM, Headphone input, AUX-in, USB