

PIKKEI



NIKKEI NMP4 MP4 PLAYER

WITH BLUETOOTH

INSTRUCTION MANUAL



DRAWINGS AND SPECIFICATIONS ARE SUBJECT TO CHANGE WITHOUT NOTICE.

Table of Contents

Features.....	3
Precautions	3
Warning.....	3
Button &function.....	4
Basic operation.....	4
Main Menu.....	4
Music Mode	5
FM Radio Mode.....	6
Video Mode.....	7
Image Mode	7
Bluetooth Mode.....	8
Record Mode.....	8
Pedometer Mode	8
History Mode	11
Stopwatch Mode.....	12
SYS Set Mode	13
Video Conversion Tool.....	13
Trouble Shooting.....	15

Feature

- 1.8-inch TFT screen display
- Bluetooth® 2.1 enabled
- Link with any bluetooth devices, transmit music from the watch to bluetooth headset and/or speakers
- Measures your steps, calculates distance, calories (optional)
- End user can use it as stopwatch
- Built-in clock function
- Plays MP3,WMA,WAV,APE,FLAC,AAC music format files
- Plays AVI (160x128) video format files
- Built in Micro-SD card slot, supports up to 32GB
- Picture browsing of JPEG format files
- Built-in 350mAh Li-poly battery
- Built-in FM RADIO (optional)
- Multi languages supported

Precautions

Follow these tips to preserve the operational lifespan of your Digital Media Player:

- It is recommended that you allow the battery to fully charge before using the device for the first time.
- Do not recharge unattended for longer than 3 hours.
- If you use a Power Adaptor (Not included), Power Adaptor current is: 5V, 500 mA.
- Do not hang the player by its earphones or cables.
- Never force any cable connectors into the ports of your Digital Media Player or computer. Always make sure that your cable connectors are identical in shape and size before attempting to connect.
- When disconnecting your Digital Media Player from a computer, use the Safely Remove Device function on your computer. Do not disconnect your Digital Media Player while transmitting data.

Warning

- Do not use this Digital Media Player in extreme temperatures. Keep away from extreme hot, cold, dry, or damp areas. Also keep away from water, fire, and radiation.
- Do not disassemble your Digital Media Player.
- Do not allow young children to use your Digital Media Player unsupervised.
- Do not install foreign software onto your Digital Media Player.

Button & function

•

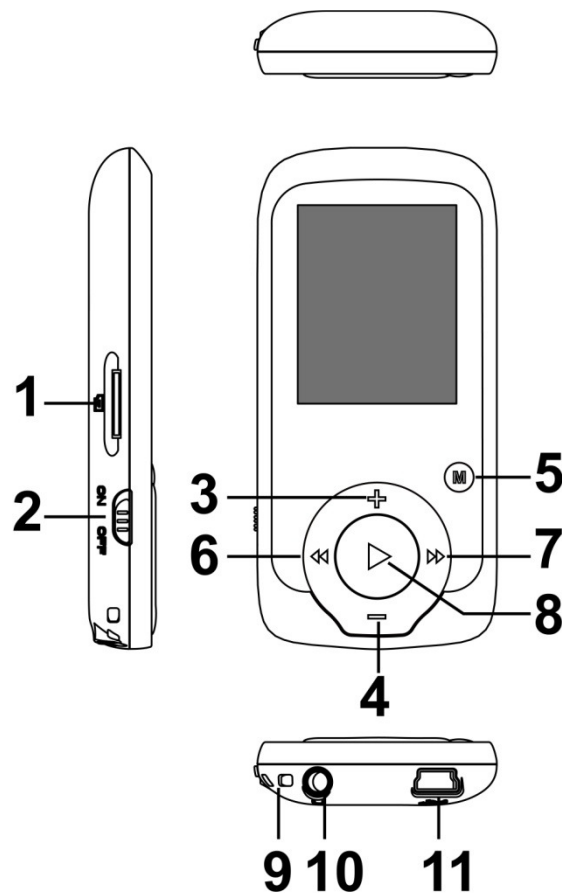

1. TF Card slot
2. ON/OFF power switch
3. VOL+
4. VOL-
5. Enter menu and exit from sub-menu
6. Last/ Backward
7. Next/Forward
8. Play/Pause、 Power ON/ OFF the player, confirm selection (under any status, hold [MENU] will enter main menu)
9. Hand strap Hole
10. Earphone socket
11. USB socket

Basic operation

Power On

Turn on the ON/OFF switch.

Then press and hold the  button for 3 seconds to power on the device.

Power Off

Press and hold the  button for 3 seconds to power off the device. Then turn off the ON/OFF switch.

Charge / Connect / Disconnect from PC



Connect the device to PC via USB Cable to use it as a Removable Disk.

To charge the device or disconnect the device, press  button when USB connected.

If you use a Power Adaptor (Not included), Power Adaptor current is: 5V, 500mA.

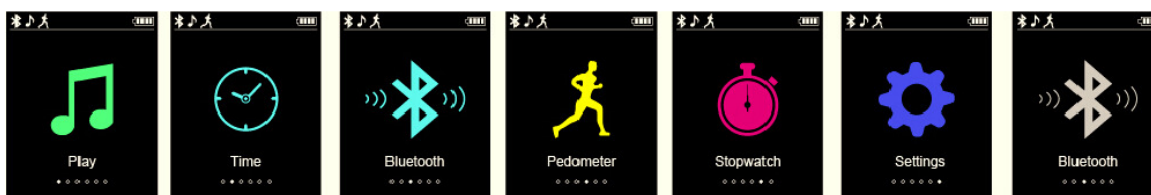

1.1 Main Menu



Music / Radio / Photo / Video / Explorer / Record	Time	Bluetooth on	Pedometer	Stopwatch	Go to setting	Bluetooth off
Small icons on left top:						
 Music Playing	 Pedometer				 Bluetooth	

1.2 Clock function



Press  and  key to choose the different clock interface, Press M to go to Menu.

2 Music Mode

2.1 Press  entry into "Play" in the main menu; press  to choose the "Music"

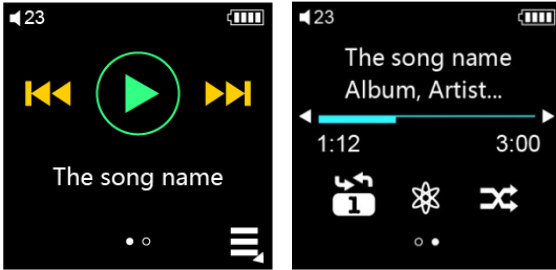











Tips: Long press M key to shift above 2 interfaces.









2.1.1 Volume

Press “ + ” and “ - ” to adjust the volume freely, the volume level is besides the speaker icon for you reference.

2.1.2 Repeat function: Pls go to setting mode, press  go to Device, you can choose repeat mode, play mode freely:

Repeat / Shuffle songs	 One once  All repeat  Folder once  Folder repeat  All once  All repeat  : Repeat the current song/all songs in folder/all songs over and over.  : Play once only the current song/all songs in folder/all song. Settings- device- play mode -  : Shuffle songs  : Play songs in turn
------------------------	---

2.1.3 Function of icons:





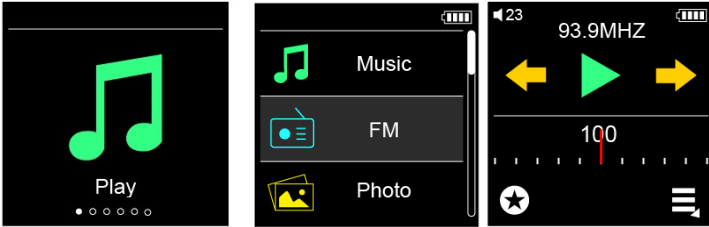

Playlists	Short press  entry into Playlists Press  or  to go to previous song or next song.
Play a paused song	press  to phase a song and play a paused song ( means play;  means pause a song)
Play the previous song	press 
Play the next song	press 





3. FM Radio



The Player uses the earphone cord as an antenna, so you must connect earphones or headphones to the Player in order to receive a radio signal. Press  go to “Radio” on the Home screen to open it.

Here is what you can do with the FM Radio controls:



Tune to an FM station	Press  or  to go to favorites (if you set any). If no favorites are set, you hear the previous or next tunable station. To tune to a particular station, drag the radio tuner.
Auto Seeking	Press and hold  or 
Pause the Radio	Press 
Resume the paused Radio	Press 
Show the radio menu	Press 

Under FM mode, Press  go to menu, press  &  to choose the function, press  to confirm.



4. Picture



Press  or  to see all the function, press  entry into Photo, first you may get view all photos.

5. Movie



Press or to see all the function, press entry into Video, Press or to choose the video you want to play. press to stop and continue the video, Press or to see previous or next video.

6. Explorer

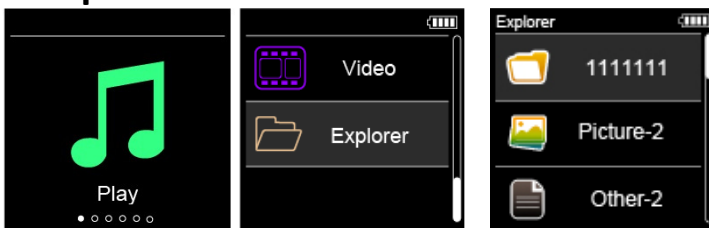



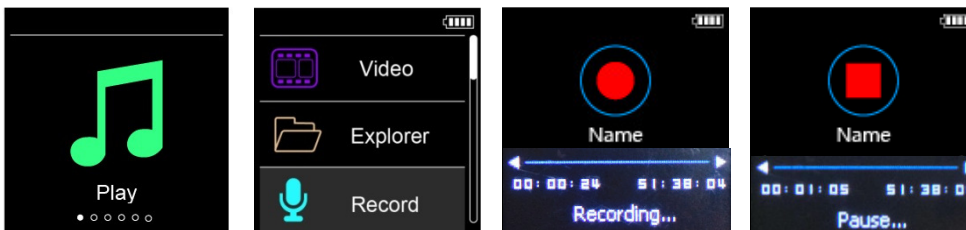





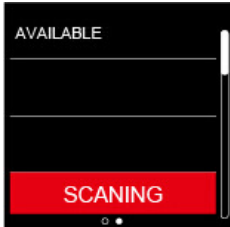

7. Record

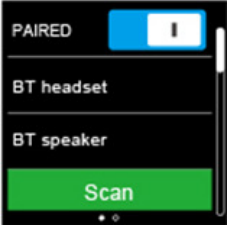

The record function is under Play, press entry into Record, press start to record the voice or pause. Press to start the second record and press again the to pause it, Press to come back to main menu, the device will be save the record file automatically.

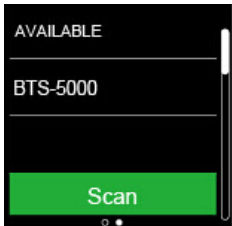
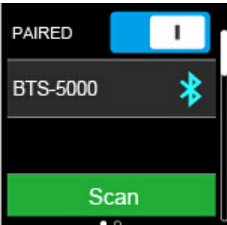
8. Bluetooth

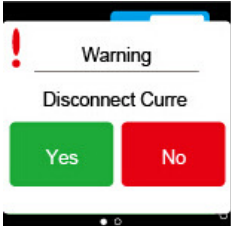

<ul style="list-style-type: none"> • Press key go to Bluetooth function 	<ul style="list-style-type: none"> • Long press “-” key to turn on BT 	<ul style="list-style-type: none"> • Long press “+” key to start scanning the BT device. 
---	--	---

		
<ul style="list-style-type: none"> ● Press  or  to choose from BT device list if scanned for many BT devices, then press  to start pair 	<ul style="list-style-type: none"> ● Paired successfully. 	<ul style="list-style-type: none"> ● Press  to remind whether cancel current connection? Press  or  then Press  to confirm 

9. Sport

This device measures steps, calculates distance, calorie.

9.1 Set user profile

Before starting using Sport, Please go to “Setting -> Move – User Profile “ to set your user profile, press V to change from first number to the second one; the red color of number means it can be adjust. Press  or  to adjust the number.



9.1.1. Set user’s walk footsteps (walk step size)

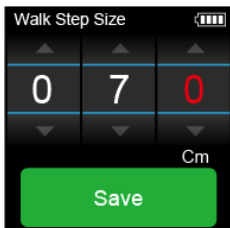

9.1.2. Set user’s run footsteps (run step size)

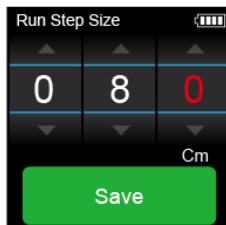

Remarks: Please put up a correct footsteps data before start to walk/run, since each footsteps size can't be keep the same, the total distance the result will be a little difference.

9.2 : Walk & Running

9.2.1.: Quick GO: go and start easily

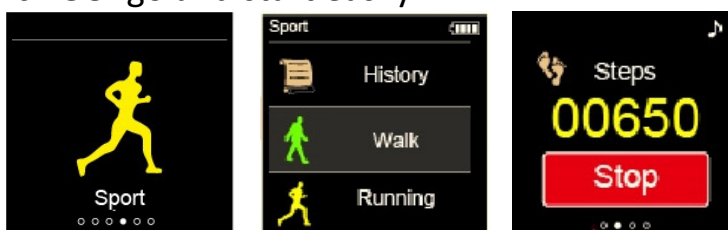

Go to walk or run to start sporty choose by or .

Tips: Pls press to stop the sporty, when Yes in Red background, you can make choose to save the data by press , choose yes or no by or , if you choose No (the background of No was in Red), means you will give up to save the data. Press to come back to main menu.

9.2.2 : History

History store 20 records. Long press the button to delete it.

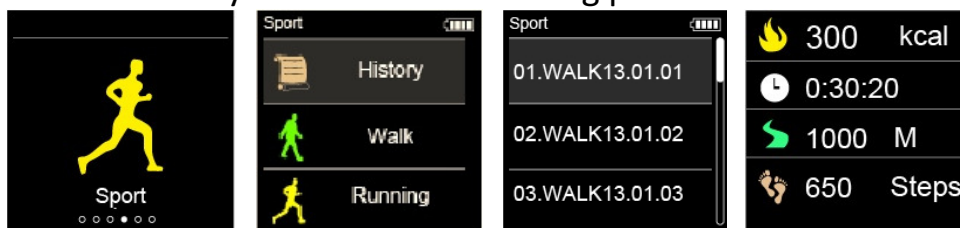

9.2.3: Select Music

Choose to have or not to have music during Walk or Running (this function is not available under QuickGO)

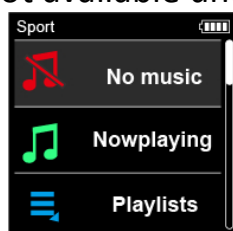

9.2.4 How to check the result?



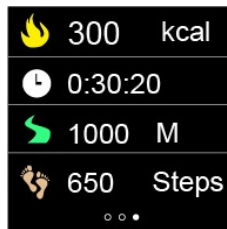

To check data





10. Stop watch

Enter "Stopwatch", Choose  button "start" to count



Press  or  to choose stop or lap (in blue background is available) to record lap numbers and the time for each lap. Every press the  to choose on "Lap" adds one lap to total lap number. Press  to choose "Stop" to pause the counting and choose "Start" again to resume it. If choose reset, the time counted will be cleared.



If laps are recorded, press  then press  to review down your lap time list.



11. Setting

Enter into "setting"

Sport: To set user profile

Device: repeat mode, play mode, display, Date and time, Languages.



12. Connecting to Computer

Connect the device to PC via USB Cable to use it as a Removable Disk.

Device is connecting with PC, press  button to exit from Connect User Interface to Main menu.

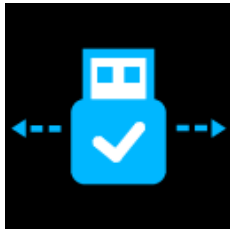

13. Video Conversion Tool

This device support AVI(160X128) video format files. The "video conversion tool" supplied with this Digital Media Player can convert most of the video format files into AVI(128X128) video format. This "video conversion tool" could be found a file folder inside the Smart Watch.

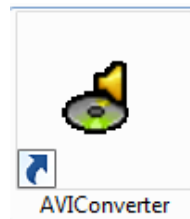

Upzip the file: then you may find this icon:

1. open the converter tool

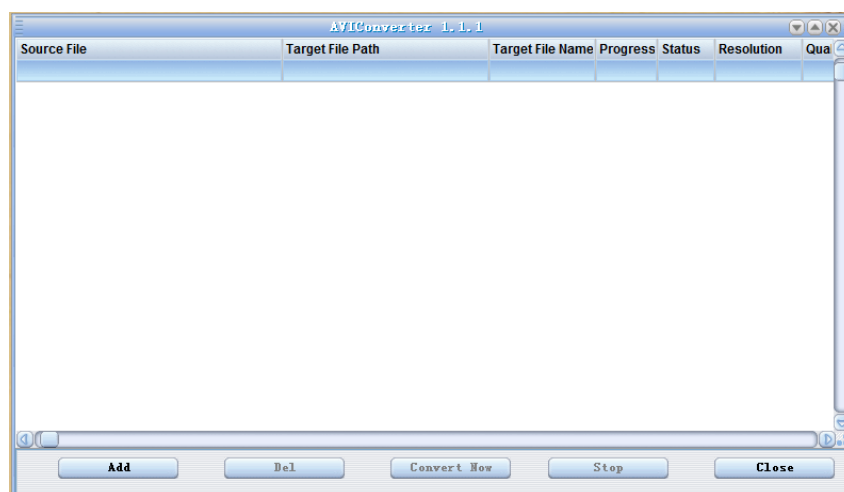

2. Click "add" and select the video source, choose the target file path, name the

file, then choose “Save”

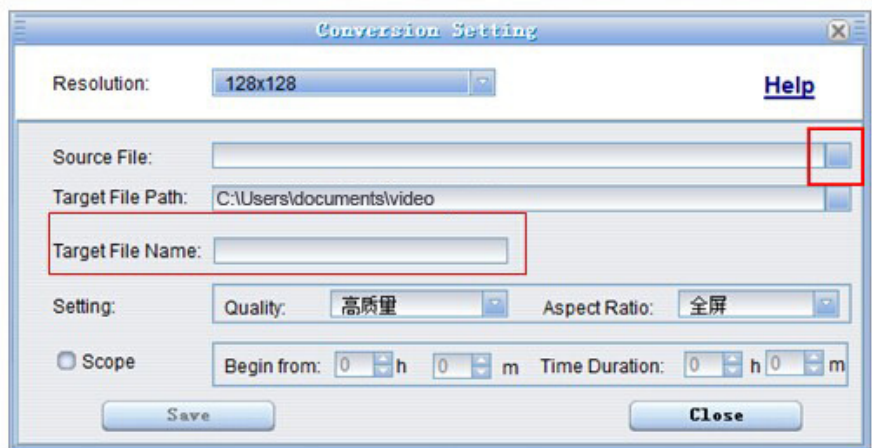

3. Click “Convert Now”, after convert is done, pls find the file through “target file path” in your computer. Then save the file into Watch to play with it.

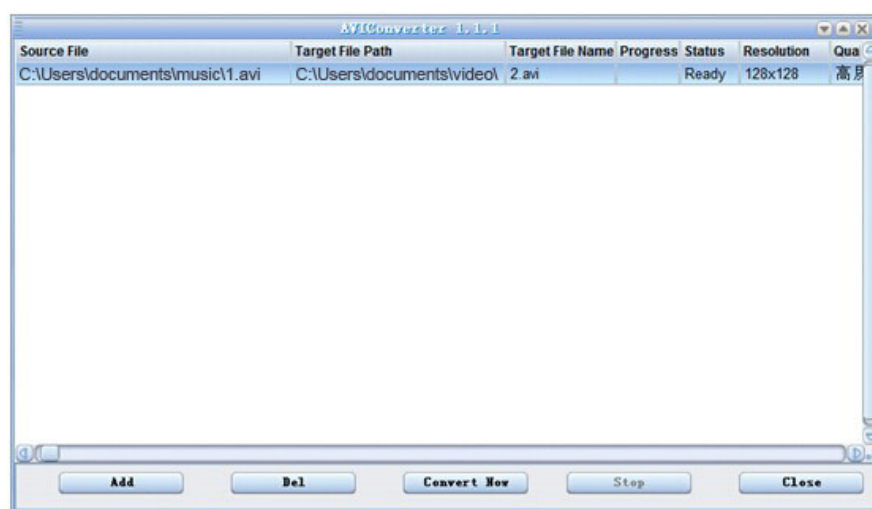

14. Trouble Shooting

Symptoms	Trouble Shooting
No power	Check battery level. Recharge the battery if required.
Can't be connect with BT device	Please make sure the BT device is switch on
Can't be connect with mobile phone	If the pairing is failed, delete the pairing, record to build a new connecting.
Unable to play files	Check and make sure that the file is in a compatible format. Convert the files into compatible formats if required.

Unable to locate files	Check to see if the file is stored in correct directory.
No music is heard in the earphones	Check the volume level.
	Check earphone is connected.
	Check if your music file is compatible with your Player.
Not charging	Check and make sure that the USB cable is properly connected to the PC and to the Smart watch
Unable to store music	Check and make sure that you have enough space on your smart watch to download the music file.
	Check and make sure that the USB cable is properly connected to the PC and to the smart watch
Computer not recognizing Digital Media Player	Check and make sure that the USB cable is properly connected to the PC and to the Smart watch
	Check and make sure USB cable is in good condition.