

Quickstart guide

NMC330
Micro set with DAB+

N|I|K|K|E|I



- (EN) For more information see the extended manual at www.nikkei.eu
- (NL) Voor meer informatie zie de uitgebreide handleiding op www.nikkei.eu
- (DE) Für weitere Informationen siehe das umfassende Handbuch unter www.nikkei.eu
- (FR) Pour plus d'informations, voir le manuel détaillé sur www.nikkei.eu
- (ES) Para más información, consulte el manual ampliado en www.nikkei.eu
- (IT) Per ulteriori informazioni consultare il manuale completo su www.nikkei.eu



1 Check the contents

Controleer de inhoud
Kontrollieren Sie den Inhalt
Vérifiez le contenu
Kontroller indholdet
Controlla i contenuti

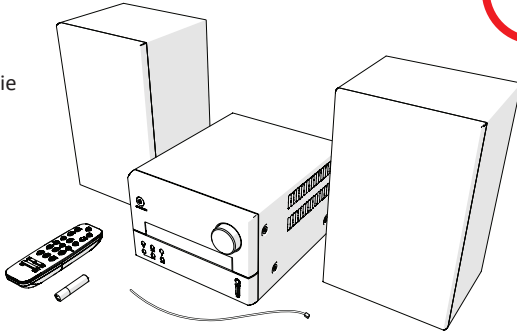

2 Main parts

Hoofd onderdelen
Hauptteile
Parties principales
Partes principales
Parti principali

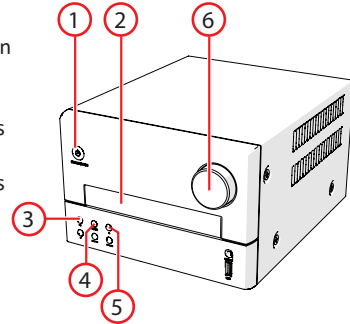

1	Standby/on
2	CD slot
3	Play/pause
4	Input
5	Open/close CD slot
6	Volume

3 Insert the batteries and remote control

Plaats de batterijen en afstandsbediening
Legen Sie die Batterien ein und Fernbedienung
Placez les piles et télécommande
Coloque las pilas y mando a distancia
Inserire le batterie e il telecomando

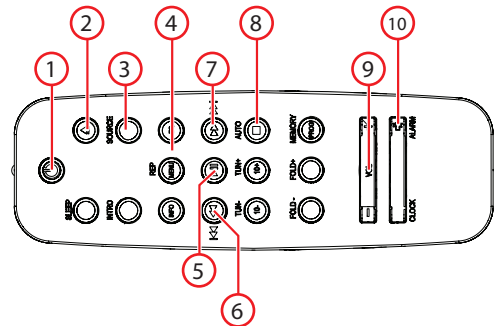
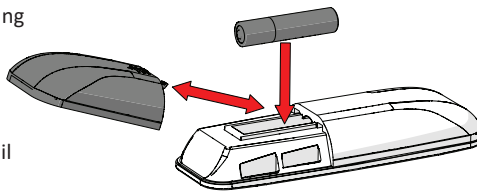

1	On/off
2	Open/close CD slot
3	Source
4	Menu
5	Play/pause
6	Play back
7	Play forward
8	Stop
9	Volume up/down
10	Mute

4 Turn on the device

Schakel het apparaat in
Schalten Sie das Gerät ein
Mettez l'appareil en marche
Encienda el aparato
Accendi il dispositivo

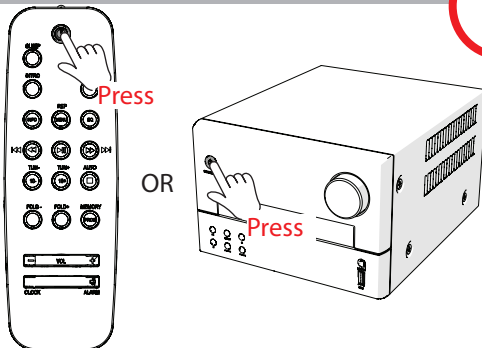

5 Connect the components and connect to the mains

Sluit de componenten aan en sluit aan op het lichtnet
Schließen Sie die Komponenten an und Schließen Sie Netzspannung an
Raccordez les composants et raccordez au réseau électrique
Conecte los componentes y conecte a la red eléctrica
Collegare i componenti e collegare alla rete elettrica

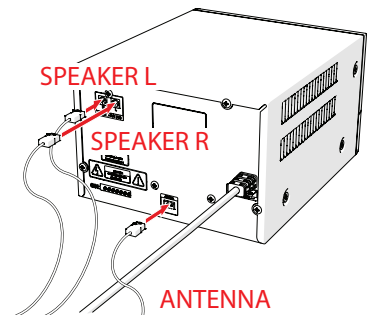

Place antenna near window and upwards

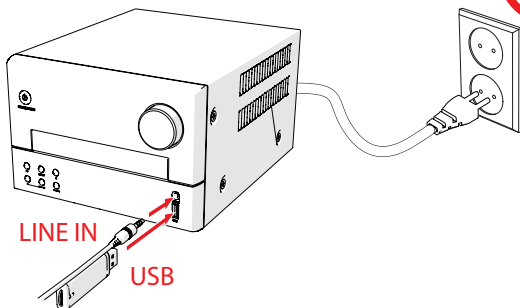
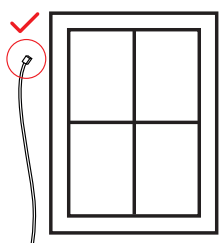

6 Source

Source
Source
Source
Source
Source

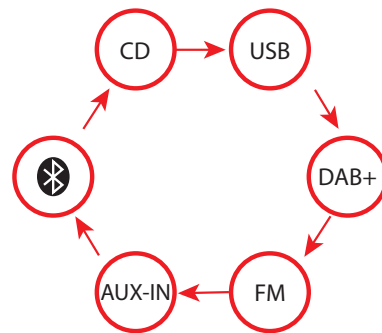
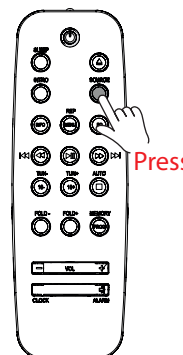

7 CD

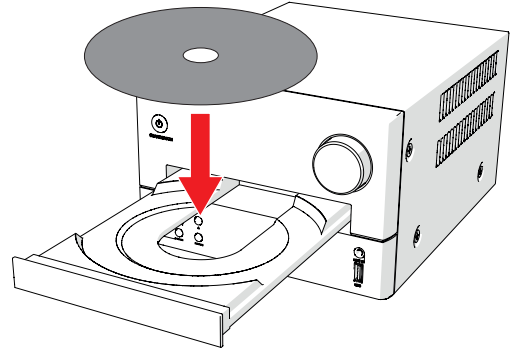
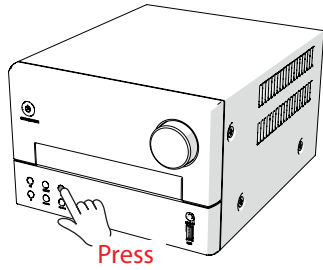
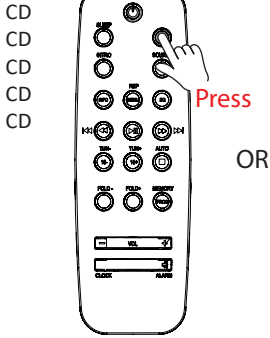

8 DAB+

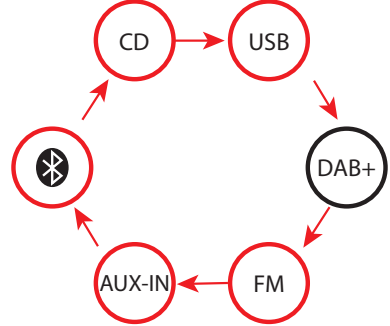
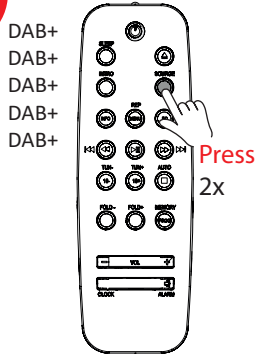
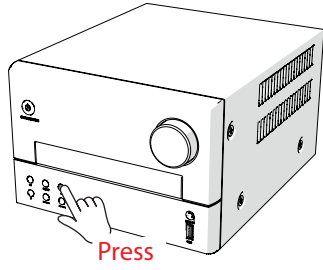
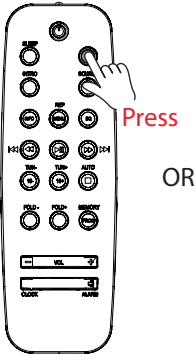

Place **antenna** near window and upwards

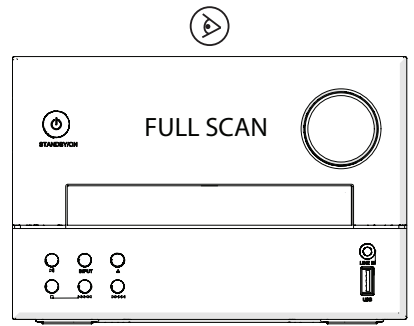
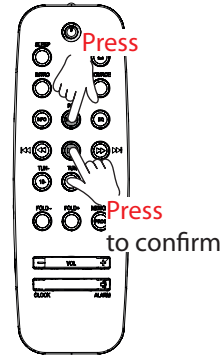
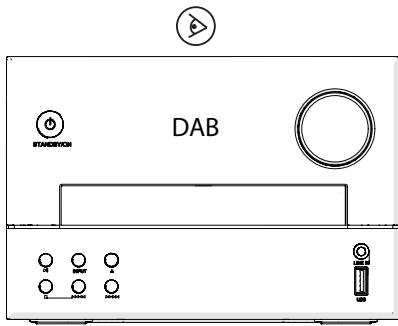
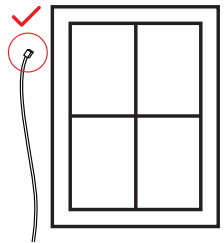

Wait...

9 Turn off the device

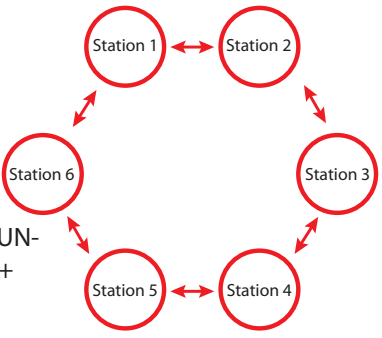
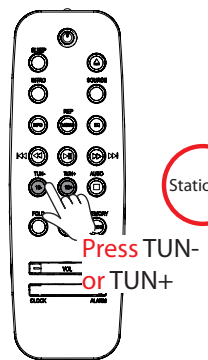

Enjoy!

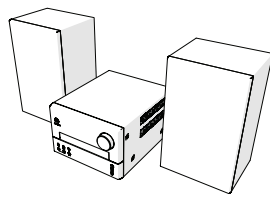

Schakel het apparaat uit
Schalten Sie das Gerat aus
teindre l'appareil
Apagar el dispositivo
Spegni il dispositivo

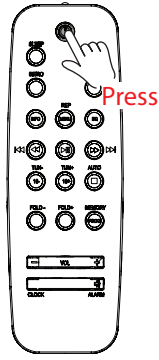

OR

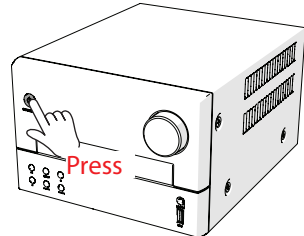

Specifications	Specificaties	Technische Daten	Spcifications	Especificaciones	Specificazioni
Battery: AAA battery (included) Dimensions: 120 x 180 x 229 mm Speakers: 2 x 15 Watt RMS (Stereo) LED display Power: 100-240 V, 50-60 Hz Media playing formats: CD, CD-R(W), MP3 Digital FM tuner, Line-in, USB playback, PLL DAB+ radio Bluetooth	Batterij: AAA batterij (inclusief) Dimensies: 120 x 180 x 229 mm Speakers: 2 x 15 Watt RMS (Stereo) LED scherm Vermogen: 100-240 V, 50-60 Hz Mediaformaten: CD, CD-R(W), MP3 Digitale FM tuner, Line-in, USB terugspelen, PLL DAB+ radio Bluetooth	Batterie: AAA Batterie (inbegriffen) Mae: 120 x 180 x 229 mm Lautsprecher: 2 x 15 Watt RMS (Stereo) LED Anzeige Leistung: 100-240 V, 50-60 Hz Medienwiedergabeformate: CD, CD-R (W), MP3 Digital FM-Tuner, Line-In, USB-Wiedergabe, PLL DAB + Radio Bluetooth	Batterie: pile AAA (fournie) Dimensions: 120 x 180 x 229 mm Puissance de sortie: 2 x 15 Watt RMS (Stre) Affichage LED Puissance: 100-240 V, 50-60 Hz Formats de lecture des supports: CD, CD-R (W), MP3 Tuner FM Digital, entre ligne, lecture USB, PLL Radio DAB + Bluetooth	Batera: batera AAA (incluida) Dimensiones: 120 x 180 x 229 mm Potencia de salida: 2 x 15 vatios RMS (estreo) Pantalla LED Potencia: 100-240 V, 50-60 Hz Formatos de reproduccin de medios: CD, CD-R (W), MP3 Sintonizador digital de FM, entrada de lnea, reproduccin USB, PLL Radio DAB + Bluetooth	Batteria: batteria AAA (inclusa) Dimensioni: 120 x 180 x 229 mm Potenza in uscita: 2 x 15 Watt RMS (Stereo) Display a LED Potenza: 100-240 V, 50-60 Hz Formati di riproduzione multimediale: CD, CD-R (W), MP3 Sintonizzatore FM digitale, Line-in, riproduzione USB, PLL DAB + radio Bluetooth