

N|I|K|K|E|I

32" HD LED TV

User manual

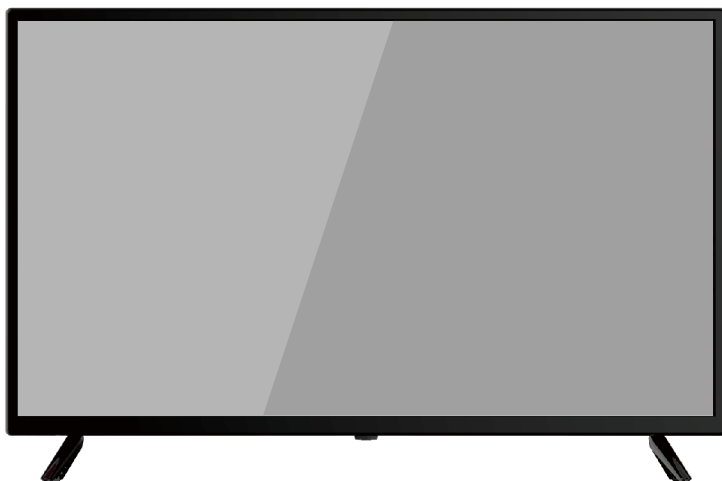



MODEL: NH3218S



IMPORTANT WARNINGS AND SAFETY ADVICE

We encourage you to read this user guide carefully and completely before installing and using your device.

It is important that this user guide is kept with the device for any new consultation. If this unit is to be transferred to another person, make sure that the user guide follows the unit so that the new user can be informed of the operation of the unit. In this user guide, the following symbols are used:

	Important information about your personal safety and how to avoid damage to the device
	General information and advice
	Environmental information
	Fire hazard
	Risk of electric shock

Important safety instructions – please read carefully and keep for future reference

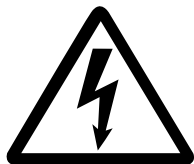

To reduce the risk of fire or electric shock, do not expose this product to water, rain or moisture. To prevent the risk of electric shock, do not remove the cover or back of this product. In case of product failure, only qualified personnel can repair. There are no user-serviceable parts inside.

CAUTION !

Dangerous tension inside the product ! Do not open. Risk of electric shock ! No parts can be repaired by the end-user. Only qualified personnel can repair and maintain this product.
If the electric cord is damaged, it must be replaced by the manufacturer or qualified after-sales personnel in order to avoid any danger.

The product must be installed in accordance with local laws. Damaged batteries must be properly disposed. In order to protect the environment, please dispose the batteries properly, in accordance with local laws (information is available at your reseller).

Remote control batteries (not included) shall not be exposed to excessive heat (e.g. from sun or fire).

Where to install the product

- Place the product on a straight, rigid and stable place. Do not place the product on a carpet.
- Do not place the product on top of another that may cause overheating (for example, a receiver or amplifier).
- Do not place anything underneath the product (for example, Cds or magazines).

Proper ventilation

- Place the product in a sufficiently-aerated place to avoid overheating. Allow at least 10cm spacing at the back and top of the product, and 5cm spacing on both sides to prevent overheating.
- Do not place items such as newspapers,tablecloth, curtains, in front of the ventilating openings.

Do not expose the product to high temperatures, moisture, water and dust.

- The apparatus shall not be exposed to dripping or splashing. No object filled with liquids, such as vases, shall be placed on the apparatus.
- Do not place other items close to this product that may damage it (for example, objects containing water or lightened candles).
- No naked flame sources, such as lighted candles, should be placed on the apparatus.

Electric supply

- Please unplug the product in case of prolonged non-use.

- If the supply cable is damaged, it must be replaced by the manufacturer or qualified after-sales personnel to avoid any danger.
- This product must be connected to an electrical supply 100-240V ~ 50/60Hz.
- The mains plug is used as the disconnect device, so the disconnect device shall remain readily operable

WARNING

Never place a television set in an unstable location. A television set may fall, causing serious personal injury or death. Many injuries, particularly to children, can be

avoided by taking simple precautions such as:

- Using cabinets or stands recommended by the manufacturer of the television set.
- Only using furniture that can safely support the television set.
- Ensuring the television set is not overhanging the edge of the supporting furniture.
- Not placing the television set on tall furniture (for example, cupboards or bookcases) without anchoring both the furniture and the television set to a suitable support.
- Not placing the television set on cloth or other materials that may be located between the television set and supporting furniture.
- Educating children about the dangers of climbing on furniture to reach the television set or its controls.
- In case this television set is to be relocated to a different location, please keep in mind and apply the above safety instructions.

Information about the meaning of the conformity marking

The CE marking indicates that the product meets the main requirements of the European Directives 2014/35/EU (Low Voltage), 2014/30/EU (Electromagnetic Compatibility), 2011/65/EU (Restriction of the use of certain hazardous substances in electronic equipment), 2014/53/EU (Radio equipment).

Technical Specification:

Name: Television Product

Net Weight: 3.6Kg

Operation Temperature: 0°C~40°C

TV Reception System: DVB-T2/C,DVB-S2

**Auto Standby**

In order to save energy, the electricity consumption of this product has been reduced in both operation mode and standby mode. Furthermore, if no operation is carried out for four consecutive hours, the unit will automatically enter standby mode. Simply press the Standby button on the remote control to switch the unit back to operation mode.

Product Introduction

Congratulations! You have chosen the latest generation high definition television. Endowed with high display quality and light weight, it is power-saving and radiationless with high sensitivity television reception. The new generation television will bring you safe & comfortable brand new visual experience. Thank you for purchasing and using our products!

Accessories

User manual x1

Remote control x1

Safety

Please immediately pull out the AC power plug of adapter if there is abnormal sound or smell or it has sound but no picture, and contact with maintenance station after confirming no abnormality.

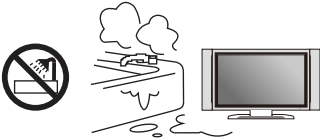

TV should be kept free from rain, damp and dust for prevention of electric shock and short circuit.

TV should be kept from high temperature heating objects or direct sunlight. TV should be placed with good ventilation.

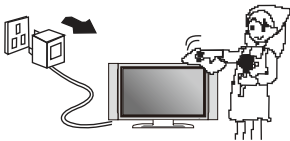
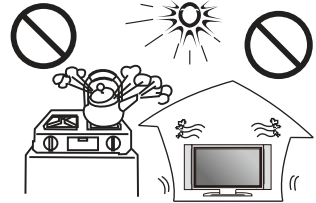

If necessary, you may clean the display with soft and clean cotton after pulling out the power plug, but do not emphatically and repeatedly wipe. Scraping, tapping or striking the display with hard object or wiping the display with grinding object is forbidden.

Do not wipe the machine with naphtha or thinner, which will lead to transformation of enclosure or breakage of coating. It may result in dirt if the machine has been contacting with rubber or ethane for long time.

It's forbidden to contact the display with organic solvents such as alcohol or gasoline or chemical solvent such as acid or alkali, etc.

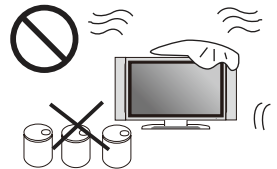

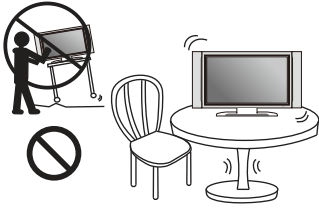

Do not put TV on unstable or shaky place

Please do not place the power line or signal line across walkway or at place where people usually come and go in case the line to be trampled.
Do not overload the power line or power socket.

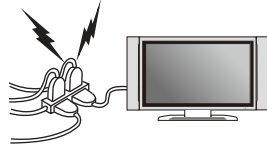

Please do not disassemble the back cover by non professionals as it has high voltage in the machine, in case for electric shock; and the internal adjustment and check should be conducted by professionals.

Do not put water container such as cosmetics or medicine liquid on TV.
Please pull out the plug and contact the maintenance station if there are abnormal objects or water in TV.

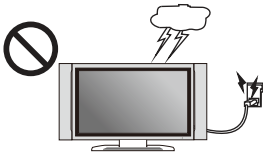
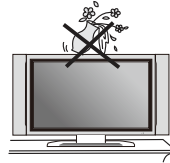

Please pull out the power plug of adapter in lightning strike, and pull out cable TV plug or outdoor antenna plug, in case the TV to be damaged.
Do not contact the lead-in line of antenna.

Table Of Contents

Important warnings and safety advice	01
I - Control Panel	09
II - Base Installation Guide	10
III - Wall Mounting instructions	11
IV - Connecting Cables	12
V - Remote Control	13
VI - Antenna Connections	16
VII - Watching Television Programs	17
VIII - HOME	18
Home	18
Search / Video	19
Music / Sport	20
App / My Apps	21
File Manager	22
Setting	23
IX - TV	24
TV source	24
Picture Setting / Sound Setting	25
Channel setting / Lock Setting	26
Time Setting / Advance Setting	27
X - Important Notice	28
XI - Troubleshooting	29

This user guide is available in the following languages:

NL (translated from the original)

EN (translated from the original)

FR (version originale)

Any other translation would be a translation of the original version.

This user guide, its possible modifications or any new version, is available on our website.

Congratulations! You have chosen the latest generation high definition television. Endowed with high display quality and light weight, it is power-saving and radiationless with high sensitivity television reception. The new generation television will bring you safe & comfortable brand new visual experience.

Thank you for purchasing and using our products!

I - Control Panel

The command buttons are at the back of the TV.
Introduction for Each Key



Turn the TV on or enter into standby mode.

II - Base Installation Guide

The Way Of Installing Base:

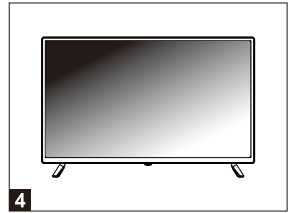
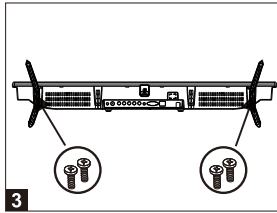
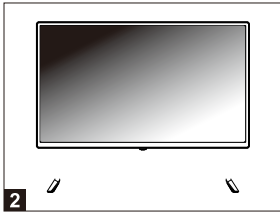
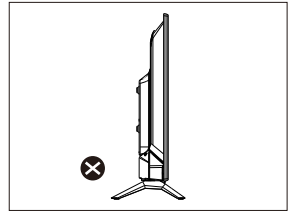
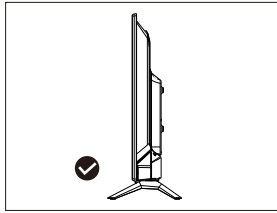
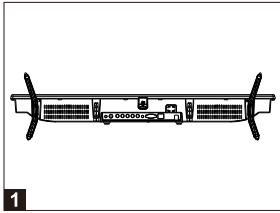

1. Please put the base on the desk as shown figure 1.
(the stand approximately 180 degrees from horizontal).
2. Put the hole of the base upright into shaft of unit(as shown figure 2).
3. Fix the stand and the screen with 4 screws (figure 3)
4. The rendering after installed (as shown figure 4).

The Way Of Unloading Base:

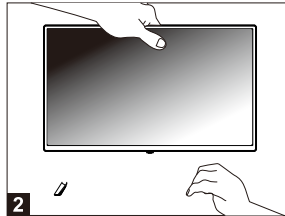
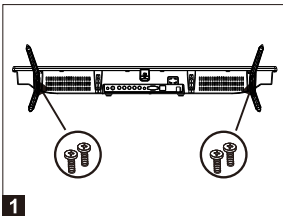

1. Please remove the screw between the base and shaft (as shown figure 1).
2. Left hand hold the cabinet of the unit, right hand hold the base then remove the stand. (as shown figure 2)

III - Wall Mounting instructions

- Use standard M6x8mm screws (4 pieces, not included) to mount this TV. Using different screws as specified will damage the wall mounting support and will be outside the scope of product guarantee.
- Contact a professional technician for assistance when wall mounting your TV.
- Do not wall mount the TV while TV is turned on.
- Refer to the instruction of your wall mounting bracket.

Back of your TV

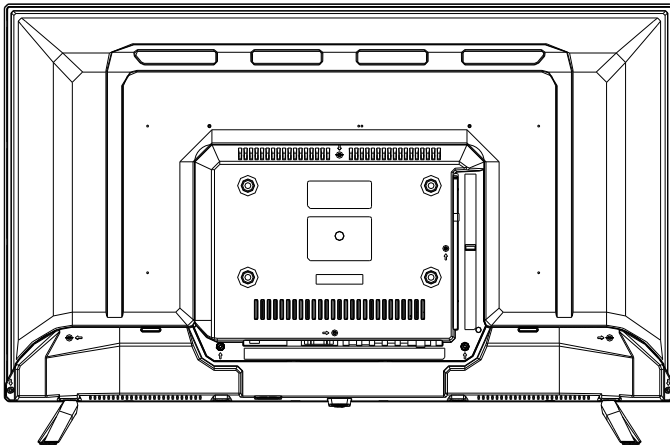

IV - Connecting Cables

This TV has digital multimedia performance and can be connected to multiple external devices. The following diagram presents the connections to other video and audio

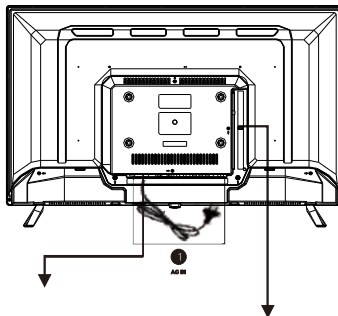

Headphone

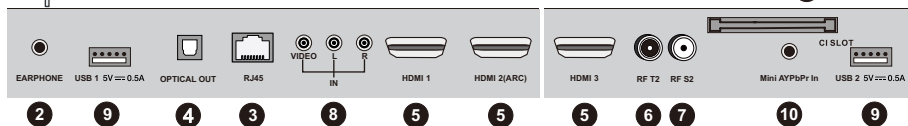

1. AC

AC 100-240V~ 50/60Hz

2. EARPHONE OUTPUT

3. RJ45

4. OPTICAL OUT

5. HDMI

High-definition multimedia interface (Note: compatible video signal 480P/576P/720P/1080i/1080P/4K)

6. RF T2

DVB-T/C.

7. RF S2

DVB-S

8. AV IN

Connect to the left/right RCA video out connection of any vide resource.

9. USB

Access multi-media files stored in the USB device.

(Note: compatible format includes: *.dat, *.vob, *.ts, *.mpg, *.avi, *.mkv, and *.mp4 for video, *.jpg and *.bmp for photo, *.mp3 for music.)

10. MiniYPbPr IN

Component input terminal.

11. CI SLOT

Insert a CI (common interface) card.

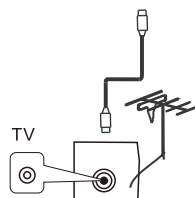

V - Remote Control

1 Power

Press this button to switch on the TV. Press again to enter the mode

2 MUTE

Press this button to cancel the output sound. Press again to set the normal audio level.

3 0-9

Figures 0-9 are used for directly the number of the input channel.

4 TV/RADIO

Switch between DVB-T and RADIO. (Digital radio is not available in countries such as France)

5 ↶

Press this button to switch to the current program to the previous one.

MOUSE

Turn the remote control mouse on or off.

6 SLEEP

Press this button to set the Delia LCD Television automatic switch-off function.

7 NICAM/A2

To choose STEREO, MONO, DUAL in the case of two languages.

8 S.MODE

Press repeatedly to scroll through the available audio modes

9 P.MODE

Press repeatedly to scroll through the available picture modes

10 SOURCE

Displays the list of signal sources in

11 CH+/-

Press the keys to scroll through the TV channels.

12 VOL+/-

Press the button to increase / decrease the audio level directly.

13 INFO

View the system status information set by the active user.

14 ASPECT

Select the aspect ratio

15 ⚙

Enter the setting menu.

16 FAV

To preview the favorite channel list.

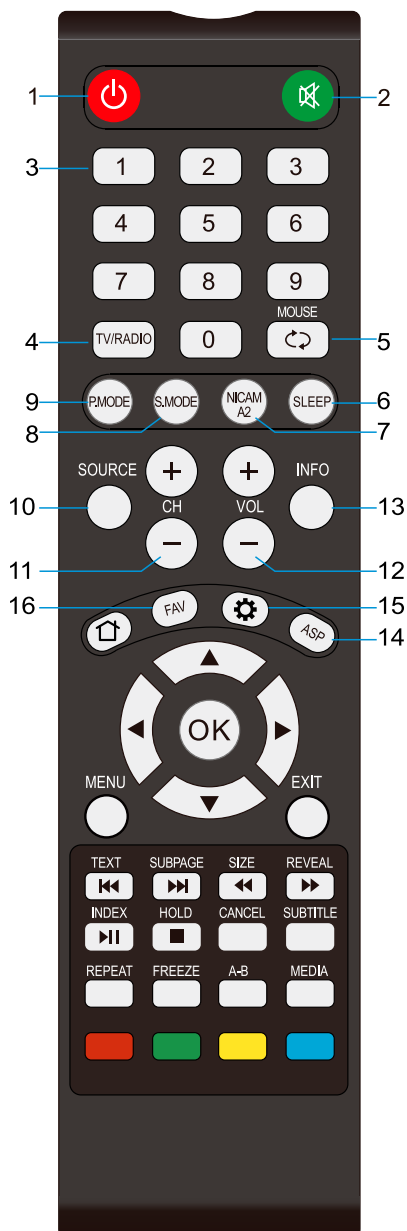

V - Remote Control

- 17  Access the home page.
- 18 **OK**
Select the option previous/next
▲/▼/◀/▶ Increase / decrease option value.
Select the option previous/next.
- 19 **MENU**
Select a menu.
- 20 **EXIT**
Return to TV viewing from any menu.
- 21 **REVEAL**
Display the characters hidden.
▶ Fast Forward.
- 22 **SIZE**
Change the size of current page.
◀ Fast Rewind
- 23 **SUBPAGE**
Display the current sub-page.
▶▶ Go to the next track or chapter
- 24 **TEXT**
Display the teletext on screen.
◀◀ Go to the next track or chapter
- 25 **INDEX**
Ask for the list of main Tv letter broadcast page number,
▶ Start/Pause
- 26 **HOLD**
Hold the current page and prevent again.
■ Stop playback
- 27 **CANCEL**
Delete TXT on screen
- 28 **SUBTITLE**
Recalls you preferred subtitle in digital mode.
- 29 **MEDIA**
Enter into the media mode(USB)directly.
- 30 **A-B**
Reproduction of fragments.
- 31 **FREEZE**
Image freezing.
- 32 **REPEAT**
Repeated playback(per file in USB).
- 33 **RED/GREEN/YELLOW/BLUE**
Available in the following ways:televideo,
DVB-T e TV.



BATTERY INSTALLATION

Install the batteries as shown in the following figures. Make sure the + and - terminals are positioned as indicated in the battery compartment (Fig. 1)-

USEFUL DURATION OF BATTERIES

- Normally the batteries last for a year, even if the consumption of the batteries depends on the effective use of the remote control.
- If the remote control does not work when it is used near the appliance, replace the batteries.
- Use two dry type 2xAAA batteries (batteries not included).

NOTE:

- Do not drop, step on or otherwise hit the remote control. This could damage the components or cause a malfunction.
- If the remote control is not used for a long time, remove the batteries.

OPERATION OF THE TV REMOTE

Point the remote control at a distance of no more than 6 m from the remote sensor and within an angle of 60 ° in front of the appliance (Fig. 2).

NOTE:

- The operating distance may vary depending on the brightness of the environment.
- Do not aim light sources at the remote sensor.
- Do not place any object between the remote control and the remote control sensor..
- Do not use this remote control when using the remote control of another device at the same time.

Fig. 1

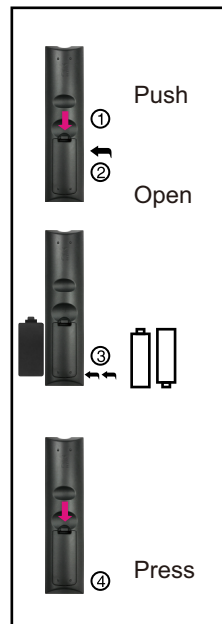
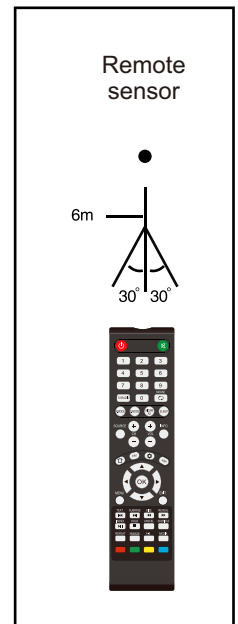

Fig. 2



VI - Antenna Connections

We recommend you use a 75Ω antenna cable so as to eliminate the disturbance caused by impedance mismatching. The antenna cable shall not be bundled together with the power cord.

Directly insert the 75Ω antenna cable plug into the antenna socket when applying cable television.

Note: The antenna should be checked periodically. If clear image is not available, shut down the power and then carefully check the antenna.

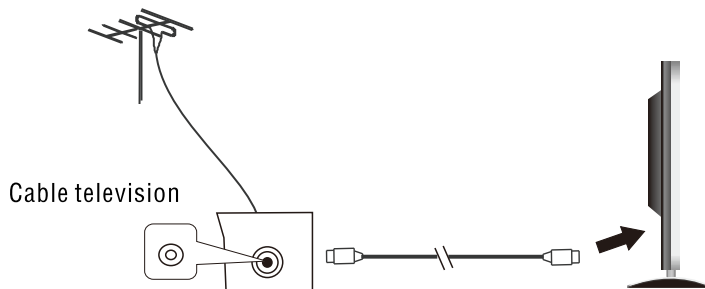

Power-on/Power-off

1. Make sure all cables are disconnected from the main unit before connecting to the AC power source.
2. Read the instructions carefully before connecting other devices.

Press the standby button again on the remote control for the television the indicating lamp becomes green, and then television image is available.

Press the standby button on the remote controller or the television to enter into standby state.

Power-saving & protection mode

1. In video or PC state, the television will enter into lower power sleep state (standby state) to conduct power saving and protection after several minutes with no signal inputs.

VII - Watching Television Programs

MAKE SURE ALL THE EQUIPMENTS AND POWER CORD ARE CONNECTED PROPERLY AND THE UNIT IS SET IN CORRECT MODE BEFORE KINDS OF OPERATIONS.

BASIC OPERATIONS

- Press POWER button on the unit or remote control to power ON the unit (indicator will glow green); press it again to power OFF (standby mode) the unit (indicator will glow red).
- Press SOURCE button on the unit or remote control to switch the unit to DTV or ATV mode.

SELECT DESIRED PROGRAM

1. Press CH+ button to play next channel.
2. Press CH- button to play previous channel.
3. Press number buttons on remote control directly to select desired program.

NOTE: Press +/- button repeatedly to switch the digit.

VOLUME CONTROL

- Press VOL+ or VOL- to adjust the level of current volume.
- Available range: 0-100.

MUTE CONTROL

- Press MUTE button to mute the sound, press it again to turn on the sound.

SOURCE SETTING

- Press SOURCE button on the unit or remote control to display the input source list.
- Press UP or DOWN navigation button to select desired input source, then press OK button to confirm selection.

Available options: DTV, ATV, YPbPr, AV, HDMI, USB.

MULTIAUDIO SATELLITE

- Press AUDIO button on remote control and use navigation buttons to select desired audio language.

NOTE: To enable this function, make sure that the channel you are viewing supports multi-audio languages.

INFORMATION DISPLAY

- Press DISPLAY button on remote control to display information of current program.

1.1 Home

The basic four application in our system is App Manager, App Store, File Manager ,Settings. They are providing the most common function of manager the TV system in launcher,such as file management, weather forecast, time display, TV signal browsing, display settings, etc. And our system home page shows some recommendation videos, and there are music and sports videos to suit the different preferences of customers.

Smart TV Launcher Overview

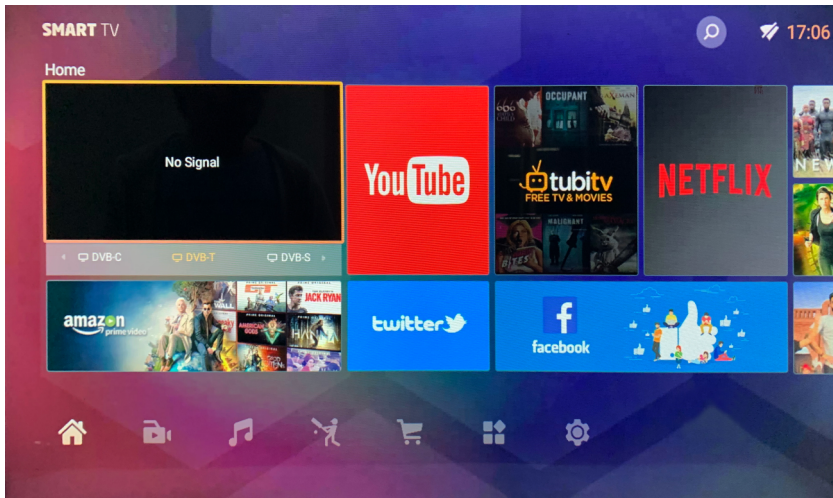

1.2 Search

You can enter an app name to search for apps.

Smart TV Launcher

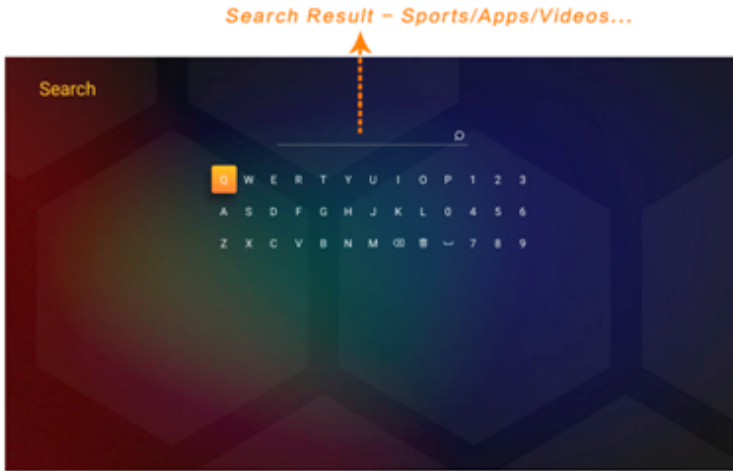

1.3 Video

In the recommended playlist, there are recommended Movies,TV series,Videos,Trailers.

Smart TV Launcher-Videos

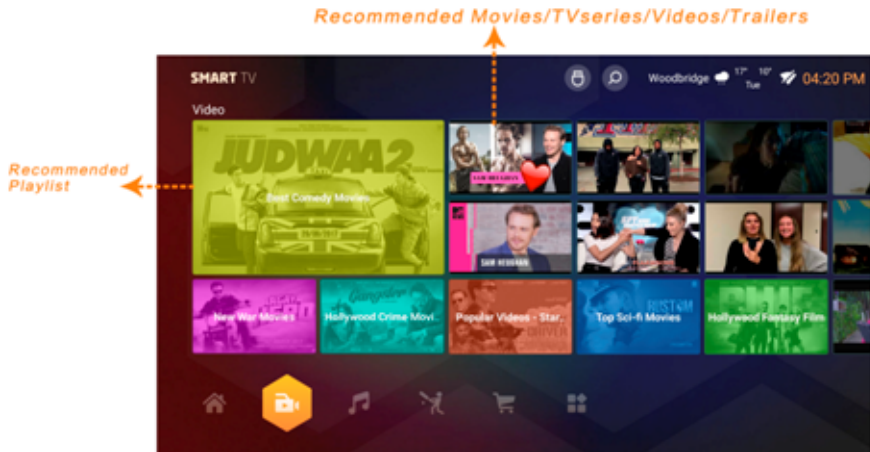

1.4 Music

In the recommended playlist, there are singles, albums, MV, etc.

Smart TV Launcher-Music

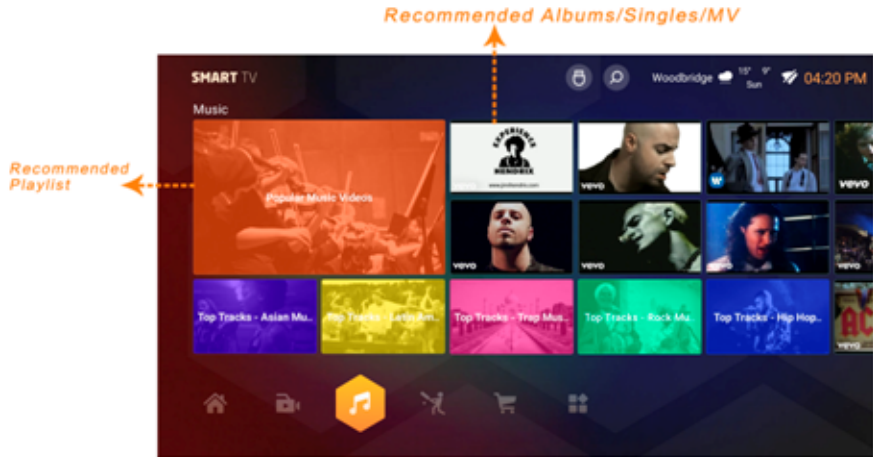

1.5 Sport

There are recommended sports videos.

Smart TV Launcher-Sports

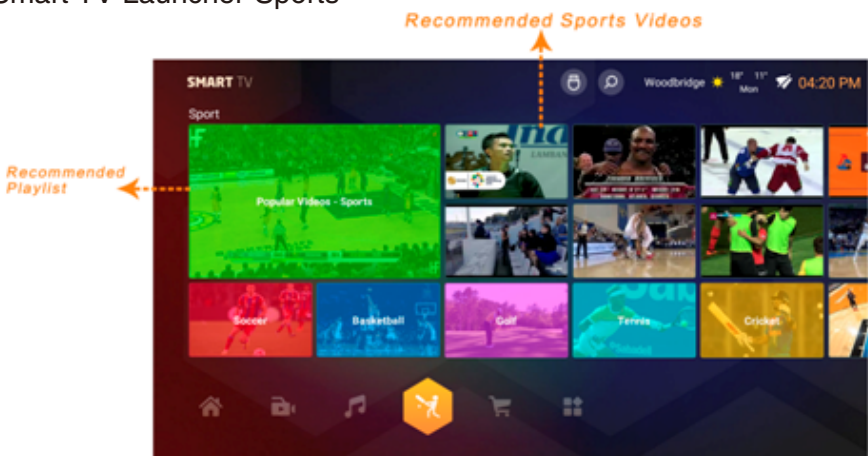

1.6 App

The TV Store is on the left side of the page, and some recommended applications on the right are available for users to download.

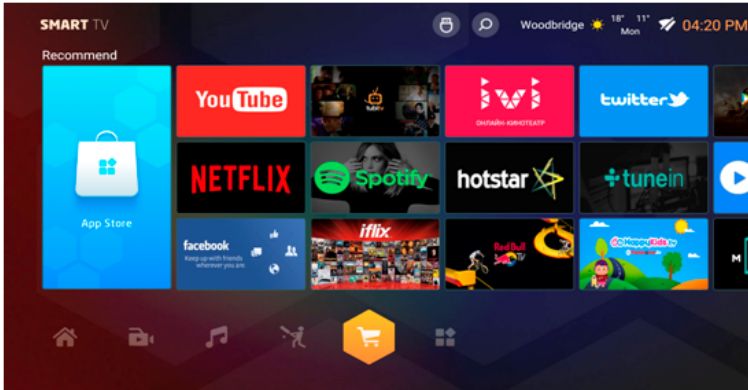

1.7 My Apps

They are pre-installed applications or users installs the application.

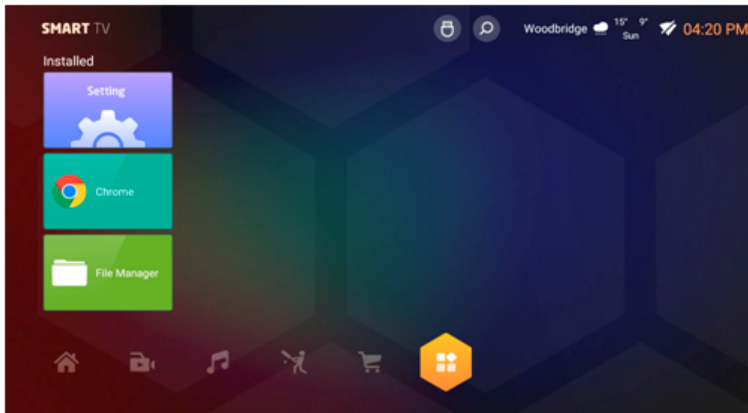

1.8 File Manager

The file Manager is used to search all files in local store and USB.

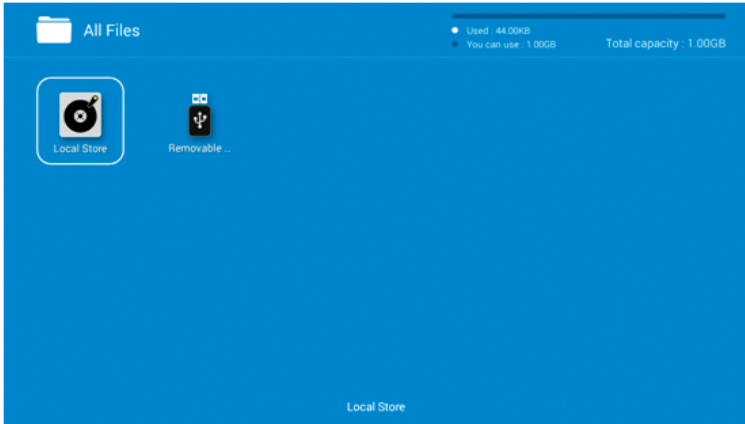

Besides, you can perform file operations by menu key, the file operation include delete, copy, paste, etc.

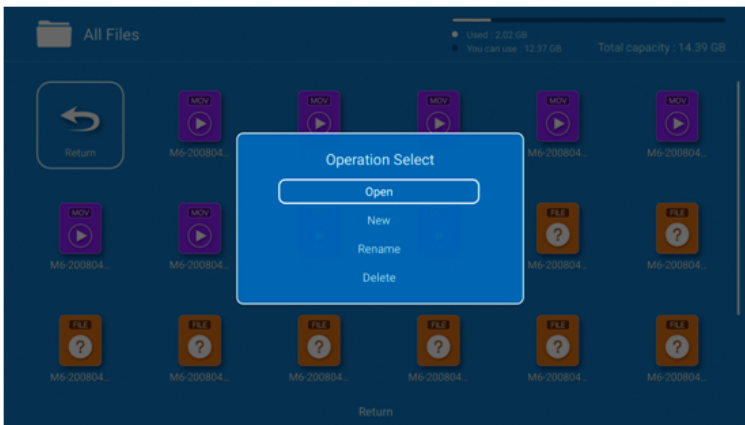

1.9 Setting

From left to right, they are NetWork, Upgrade and Advaced,Restore , AboutSystem.You can configure the network, upgrade the software, select the language, set the time, restore the factory settings, view the software version, and so on.

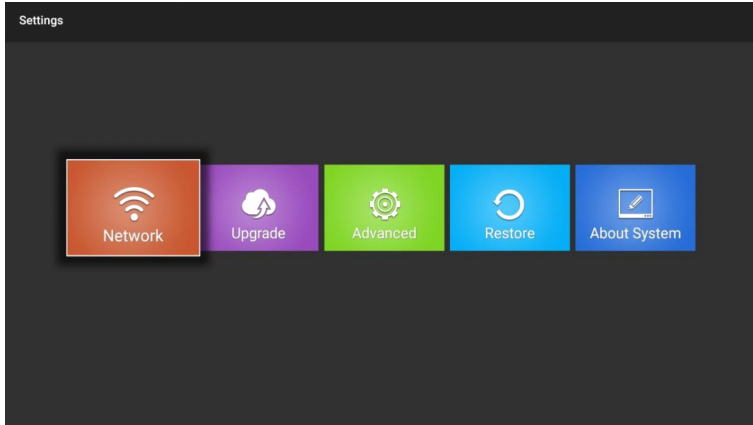

IX - TV

In the source of TV, user can bring up the TV menu interface by menu key. This interface provide user some rights to set TV properties and totally we have five choices .They are Channel Setting, Picture Setting, Sound Setting, Time and Date Setting, Other Setting, respectively. Lastly, introduce them to you.

2.1 TV source

In TV interface, if you want to change channel, you can press the source key to launch tv source change application to select different channels.

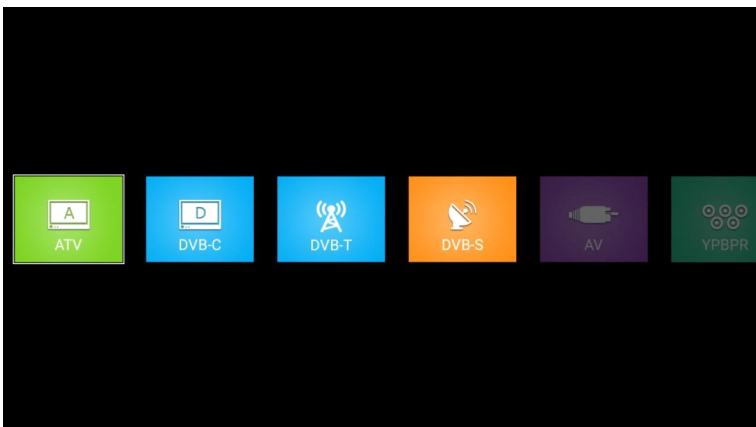
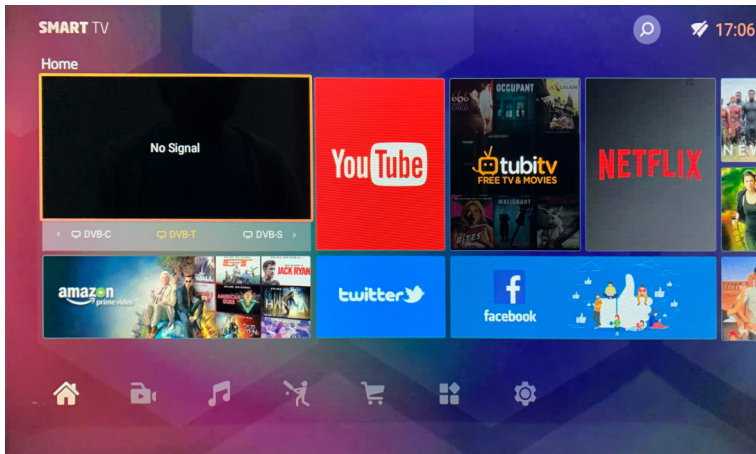

2.2 Picture Setting

You can adjust the display mode, white balance, saturation, etc. of the picture in the picture mode. You can adjust the display size ratio in the display settings, and adjust the color style,DNR, etc. in the advanced setting.

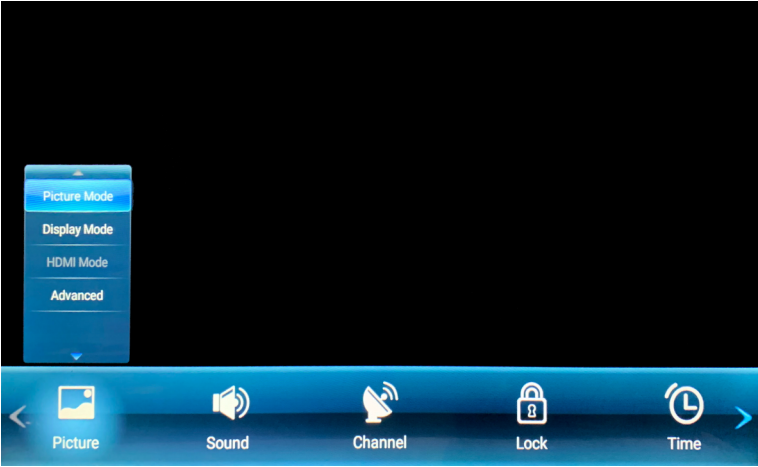

2.3 Sound Setting

Here you can set the sound mode, the sound output device, etc.

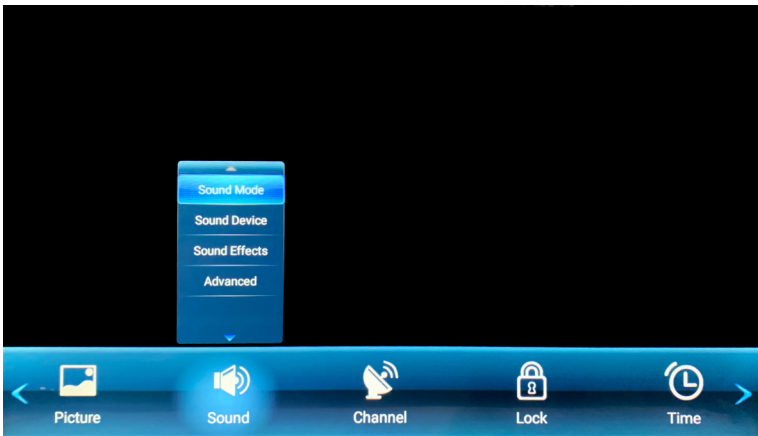

2.4 Channel setting

Here you can search for channels, learn about program information, adjust channel order, edit channel names, etc.

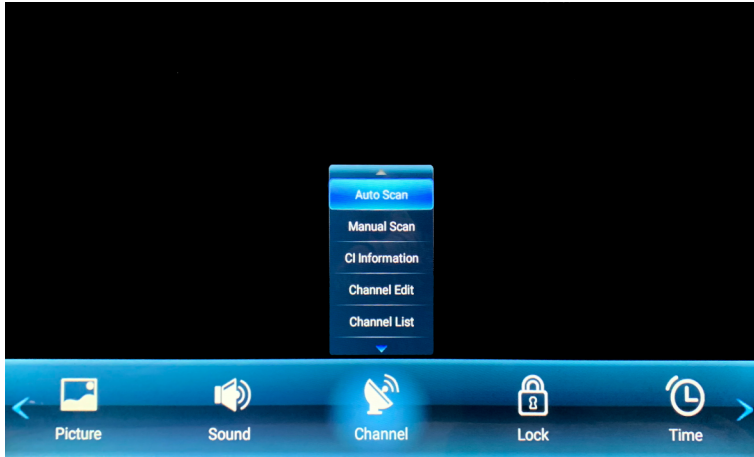

2.5 Lock Setting

You can set the parental lock here, play only the channel programs that the child can watch, or set a single channel lock, play source lock, etc. to customize the channel list.

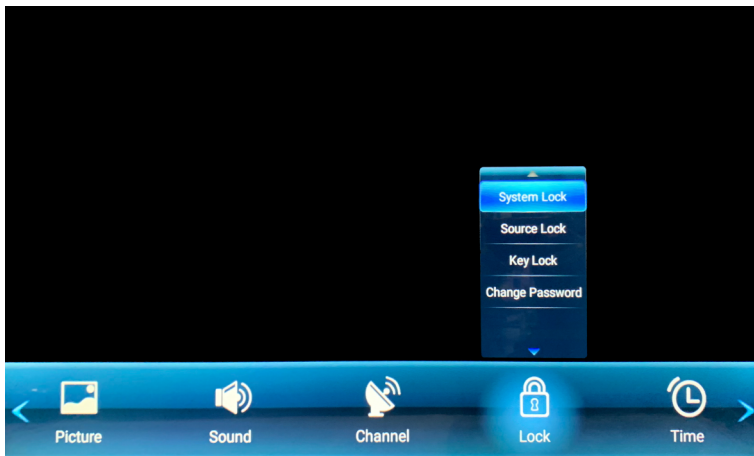

2.6 Time Setting

You can set the TV display time, switch time, menu display duration, etc.

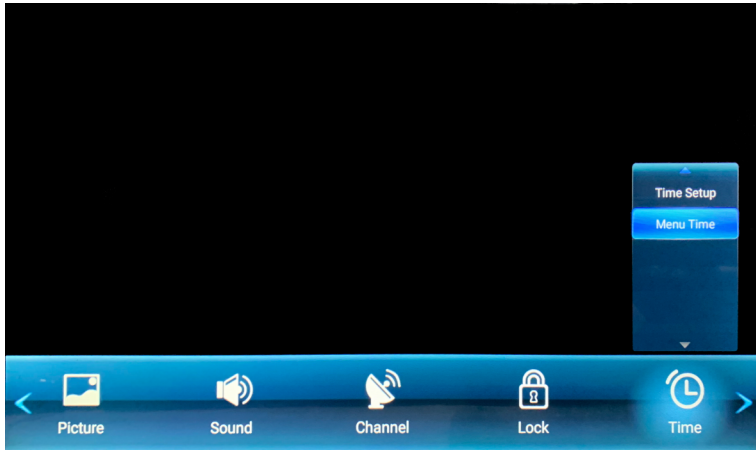

2.7 Advance Setting

You can set the TV language, adjust CEC device, adjust subtitle display, clear user settings, etc.

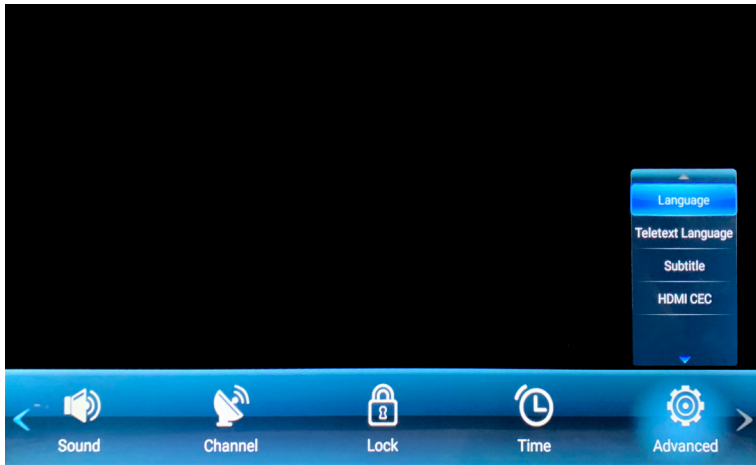

X - Important Notice

The display of this television is made up of a large number of colour pixels. Although it has at least 99.999% of effective pixels, some black dots or bright spots (red, green or blue) may appear constantly on the screen. This is a characteristic of the screen (according to industrial standards), and is not a defect.





Sometimes, the screen may include an unlit pixel, which will be seen as a blue, red, green or black dot. This does not affect the functioning of the product and should be considered normal.

Note on Defective Pixels

Your product has been manufactured with great care. Nevertheless, it is possible that some pixels remain constantly on or unlit. Please refer to the table below about the tolerance level for defective pixels on this product.

Screen Size	Resolution	No. of Bright or Dark Sub-Pixels (Color Pixels)	No. of Bright or Dark Pixels (White or Black)	Continuous Line
32	1366*768	5	2	0

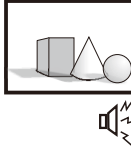
XI - Troubleshooting

<p>No image and voice</p> 	<p>Possible causes:</p> <ul style="list-style-type: none"> *Power cord, antenna or input devices are not connected; *The TV set is not powered on. <p>Solutions:</p> <ul style="list-style-type: none"> *Check Power cord ,antenna and input devices; *Press Power key on the remote control; *Press Power key on the set to power it off for 5 seconds and then re-power it on .
<p>No voice</p> 	<p>Possible causes:</p> <ul style="list-style-type: none"> *The volume is too low;Muted or cancelled; *Incorrect sound system. <p>Solutions:</p> <ul style="list-style-type: none"> *Press Volume key to turn up the volume; *Press Mute key to cancel Mute mode. Well connect vconnection to the background sound; *Change the sound system in the menu.
<p>Snows and noises:</p> 	<p>Possible causes:</p> <ul style="list-style-type: none"> *The cable is damaged or gets loose; *Incorrect channel preset; *Improper antenna positioning. <p>Solutions:</p> <ul style="list-style-type: none"> *Check whether the connection of the antenna cable , DVD and the cables is correct; *Reset channels or fine tune the channel; *Adjust the direction of the antenna.
<p>Achromatic colour</p> 	<p>Possible causes:</p> <ul style="list-style-type: none"> *Incorrect Colour system settings;Low chroma level setting ; *Improper antenna positioning. <p>Solutions:</p> <ul style="list-style-type: none"> *Change the colour system into the local system in the menu ; *Increase chroma level; *Adjust the direction of the antenna.
<p>Remote control is no effect :</p> 	<p>Possible causes:</p> <ul style="list-style-type: none"> *Battery runs up; *Incorrect battery loading; <p>Solutions:</p> <ul style="list-style-type: none"> *Check the battery electricity or replace the battery; *Check if the poles of the battery are correct.
<p>Note: To properly watch CANAL + using this product, carry out DVB-T channel search when CANAL + is unsarambled. Form 12:30 p.m. to 1:30 p.m. From 7:00 p.m.to 8:30 p.m.</p>	

For any other problem that may occur on your device, please contact Customer Service.

Elmarc B.V.
Kolenbranderstraat 28
2984 AT Ridderkerk
The Netherlands