

INSTRUCTION MANUAL

BEDIENUNGSANLEITUNG

MANUAL INSTRUCIUNI

РЪКОВОДСТВО ЗА ЕКСПЛОАТАЦИЯ

UPUTE ZA UPORABU

UPUTSTVO ZA UPOTREBU

PRIRUČNIK

FLAT DIGITAL TV

DIGITALER FLACHBILDFERNSEHER

TELEVIZOR DIGITAL CU ECRAN PLAT

LCD / LED ТЕЛЕВИЗОР

FLAT DIGITALNI TV PRIJAMNIK

FLAT DIGITALNI TV

ZARAVAN DIGITALNI TELEVISOR

HITACHI



1 Insert the batteries into the Remote Control

Insert two **AAA/R3** or equivalent type batteries inside. Observe the correct polarity (+/-) when inserting batteries and replace the battery cover.



2 Connect the antenna to your TV

** The back connection options may differ depending on the model*

REAR SIDE OF THE TV

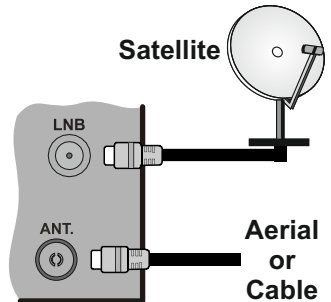

3 Connect the TV to the mains socket

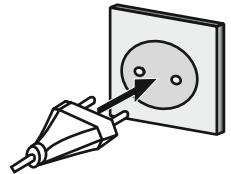

4 To switch the TV on (depending on the model)

After connecting the power cord to the mains socket, the standby LED lights up.

To switch on the TV from standby mode either;

1. Press the **Standby** button, a numeric button or **Programme +/-** button on the remote control.
2. Press the **Standby** button or **Programme +/-** button on the TV.

----- or -----

2. Press the side function switch on the TV until the TV comes on from Standby.

** The appearance of the remote control buttons and the position of the control buttons on the TV may differ depending on the model*

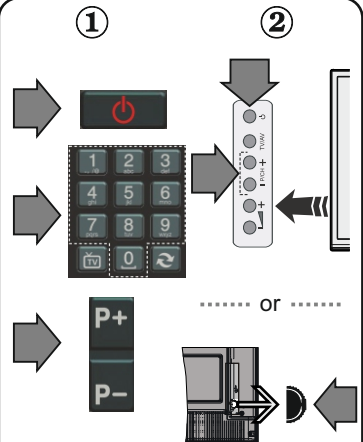

5 HDMI input

PLEASE ENSURE BOTH UNITS ARE SWITCHED OFF BEFORE CONNECTING. Use a HDMI to HDMI cable to connect the two units together. To select the HDMI input, press the **Source** button on the remote control. Each time it is pressed the on-screen menu confirms your selection.

** The appearance of the **Source** button may differ depending on the model of the remote control*

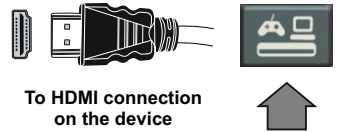

6 Auto Setup procedure (depending on the model)

When the TV is operated for the first time, installation wizard will guide you through the process. First, language selection screen will be displayed. Select the desired language and press **OK**. On the following screens, set your preferences using the directional buttons.

About Selecting Broadcast Type

Digital Aerial: If this broadcast search option is turned on, the TV will search for digital terrestrial broadcasts after other initial settings are completed.

Digital Cable: If this broadcast search option is turned on, the TV will search for digital cable broadcasts after other initial settings are completed. According to your other preferences a confirmation message may be displayed before starting to search. Select **Yes** and press **OK** to proceed. To cancel operation, select **No** and press **OK**. You can select **Network** or set values such as **Frequency**, **Network ID** and **Search Step**. When finished, press **OK** button.

Note: Searching duration will change depending on the selected Search Step.

Satellite: If **Satellite** broadcast search option is turned on, the TV will search for digital satellite broadcasts after other initial settings are completed. Before satellite search is performed some settings should be made. Antenna Type menu will be displayed first. You can select **Antenna Type** as **Direct**, **Single Satellite Cable** or **DiSEqC switch** by using directional buttons.

Analogue: If Analogue broadcast search option is turned on, the TV will search for analogue broadcasts after other initial settings are completed.

Additionally you can set a broadcast type as your favourite one. Priority will be given to the selected broadcast type during the search process and the channels of it will be listed on the top of the channel list. When finished, press **OK** to continue.

You can activate **Store Mode** option at this point. This option is intended only for store use. It is recommended to select **Home Mode** for home use.

Press **OK** button on the remote control to continue and the **Network/Internet Settings** menu will be displayed. Please refer to the next section about internet connection on the next page to configure a wired or a wireless connection. After the settings are completed press **OK** button to continue.

After the initial settings are completed TV will start to search for available broadcasts of the selected broadcast types.

After all the available stations are stored, scan results will be displayed. Press **OK** to continue. The **Edit Channel List** menu will be displayed next. You can edit the channel list according to your preferences or press the **Menu** button to quit and watch TV.

Note: Do not turn off the TV while initializing first time installation.

7 Connect your TV to the Internet

Connectivity feature allows you to connect your TV to the home network wired or wirelessly. You can use this networking system to connect to the Portal or to access photo, video and audio files that are stored on a Media server connected to the network and play/display them on the TV.

However, if your TV does not have Wireless USB dongle or doesn't support internal Wi-Fi feature, you should use wired connection type. Add your TV to your home network by connecting it to the modem/router via an LAN cable (not supplied) as illustrated.

To use your TV with your wireless network, you may need a Wireless USB dongle. You should connect it to one of the USB inputs on the TV. If your TV supports internal Wi-Fi feature you won't need any additional wireless adaptors.

Press the **Menu** button to open the main TV menu. Select **System>Settings** by using the directional buttons and press **OK** to enter. Highlight **Network/Internet Settings** and press **OK**. While **Network Type** is highlighted, press Left or Right buttons to select connection type. Wired connection will be established automatically. If wireless connection is selected TV will search for the available wireless networks and list them when finished. Select one and press the **OK** button to connect. If the wireless network is password protected you should enter the correct code to access the network. Once you have established a wireless connection, this will be saved and you shouldn't enter the password to connect to the same wireless network again. You can delete the saved wifi profile any time. If a **First Time Installation** is performed, this profile will be deleted as well.

Press the **Internet** button on the remote to access internet portal, while your TV is connected. You can access a wide range of applications and services, using the internet portal feature of your TV.

Note: Portal page content is subject to change at any given time without prior notice.

Nero MediaHome software download link: <http://www.nero.com/mediahome-tv>.

Refer to the instruction manual for more details.

Wireless Connection

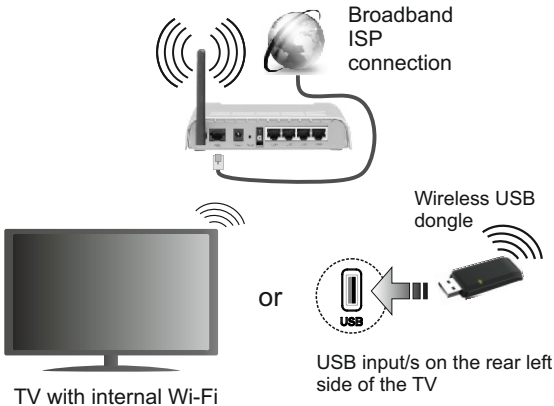

Wired Connection

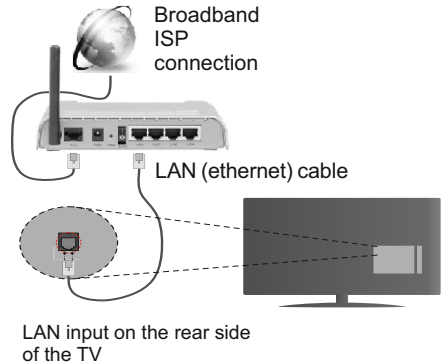

Contents

Safety Information	2
Markings on the Product.....	3
Preparation.....	3
Features	4
Specification	5
Disposal information.....	5
Remote Control RC 4848 (depending on the model) ...	6
TV and Operating Buttons (depending on the model).....	8
Power Connection	8
Antenna Connection (depending on the model).....	8
Environmental Information.....	9
Standby Notifications.....	9
First Time Installation (depending on the model)...	9
Media Playback via USB Input	10
Timeshift Recording.....	11
Instant Recording	11
Media Browser Menu.....	11
Recording a Programme	11
Watching Recorded Programmes	12
Recording Configuration.....	12
FollowMe TV (depending on the model).....	12
CEC and CEC RC Passthrough (depending on the model).....	12
E-Manual (depending on the model)	12
General TV Operation	13
Using the Channel List	13
Configuring Parental Settings.....	13
Electronic Programme Guide (EPG)	13
Software Upgrade.....	14
Troubleshooting & Tips.....	14
Connectivity Functions (depending on the model) ..	15
Supported Video File Formats for USB Mode	20
Supported Picture File Formats for USB Mode	20
Supported Audio File Formats for USB Mode	21
Supported Subtitle File Formats for USB Mode ...	22
Supported Subtitle File Formats for USB Mode ...	22
Supported DVI Resolutions	23
Internet Portal functionality information	24
DVB functionality information	24

Safety Information



CAUTION
RISK OF ELECTRIC SHOCK
DO NOT OPEN



CAUTION: TO REDUCE THE RISK OF ELECTRIC SHOCK DO NOT REMOVE COVER (OR BACK). NO USER-SERVICEABLE PARTS INSIDE. REFER SERVICING TO QUALIFIED SERVICE PERSONNEL.

Don't operate your TV in extreme ambient conditions as this may cause damage to your TV.



Before extreme weather (storms, lightning) and long inactivity periods (going on holiday) disconnect the TV set from the mains. The mains plug is used to disconnect TV set from the mains and therefore it must remain readily operable.



This sign is present wherever there is very important information on operation and maintenance of the appliance in the literature accompanying it.



Note: Follow the on screen instructions for operating the related features.







IMPORTANT - Please read these instructions fully before installing or operating

WARNING: Never let people (including children) with reduced physical, sensory or mental capabilities or lack of experience and / or knowledge use electrical devices unsupervised.

- For ventilation purposes, leave a free space of at least 10 cm all around the set.
- **Do not** block ventilation holes.
- **Do not** place the TV on sloping or unstable surfaces, the TV may tip over.
- Use this device in moderate climates.
- The power cord plug should be easily accessible. **Do not** place the TV, furniture, etc. on the power cord. A damaged power cord/plug can cause fire or give you an electric shock. Handle the power cord by the plug, **do not** unplug the TV by pulling the power cord. Never touch the power cord/plug with wet hands as this could cause a short circuit or electric shock. Never make a knot in the power cord or tie it with other cords. When damaged it must be replaced, this should only be done by qualified personnel.
- **Do not** use this TV in a humid or damp environment. Do not expose the TV to liquids. In case the cabinet contacts any liquids unplug the TV immediately and have it checked by qualified personnel before operating it any further.

- **Do not** expose the TV to direct sunlight, open flames or place it near intense heat sources such as electric heaters. 
- Listening in excessive volumes from earphones and headphones may cause hearing loss.
- Ensure that no open flame sources, such as lit candles, are placed on top of the TV. 
- To prevent injuries, this TV must be securely attached to a wall by carefully following the instructions (if the option is available).
- Occasionally, a few non-active pixels may appear on the screen as a fixed blue, green or red point. Please note that this does not affect the performance of your product. Take care not to scratch the screen with fingernails or other hard objects.
- Before cleaning, unplug the TV from the wall socket. Only use a soft, dry cloth while cleaning.

 Warning	Serious injury or death risk
 Risk of electric shock	Dangerous voltage risk
 Caution	Injury or property damage risk
 Important	Operating the system correctly
 Notice	Additional notes marked

Markings on the Product

The following symbols are used **on the product** as a marker for restrictions and precautions and safety instructions. Each explanation shall be considered where the product bears related marking only. Note such information for security reasons.



Class II Equipment: This appliance is designed in such a way that it does not require a safety connection to electrical earth.



Class II Equipment With Functional Earthing: This appliance is designed in such a way that it does not require a safety connection to electrical earth, the earth connection is used for functional purposes.



Protective Earth Connection: The marked terminal is intended for connection of the protective earthing conductor associated with the supply wiring.



Hazardous Live Terminal: The marked terminal(s) is/are hazardous live under normal operating conditions.



Caution, See Operating Instructions: The marked area(s) contain(s) user replaceable coin or button cell batteries.



Class 1 Laser Product: This product contains Class 1 laser source that is safe under reasonably foreseeable conditions of operation.

WARNING

Do not ingest the battery, Chemical Burn Hazard

(The accessories supplied with or) This product may contain a coin/button cell battery. If the coin/button cell battery is swallowed, it can cause severe internal burns in just 2 hours and can lead to death.

Keep new and used batteries away from children.

If the battery compartment does not close securely, stop using the product and keep it away from children.

If you think batteries might have been swallowed or placed inside any part of the body, seek immediate medical attention.

WARNING

Never place a television set in an unstable location. A television set may fall, causing serious personal injury or death. Many injuries, particularly to children, can be avoided by taking simple precautions such as;

- Using cabinets or stands recommended by the manufacturer of the television set.
- Only using furniture that can safely support the television set.
- Ensuring the television set is not overhanging the edge of the supporting furniture.
- Not placing the television set on all furniture (for example, cupboards or bookcases) without anchoring both the furniture and the television set to a suitable support.
- Educating children about the dangers of climbing on furniture to reach the television set or its controls.

If your existing television set is being retained and relocated, the same considerations as above should be applied.

Preparation

For ventilation, leave a free space of at least 10 cm all around the set. To prevent any fault and unsafe situations, please do not place any objects on top of the set. Use this device in moderate climates.

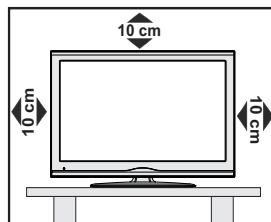

Features

- Remote controlled colour TV
- Fully integrated digital terrestrial/cable/satellite TV (DVB-T-T2/C/S-S2)
- Fransat Installation Option
- HDMI inputs to connect other devices with HDMI sockets
- USB input
- OSD menu system
- Scart socket for external devices (such as DVD Players, PVR, video games, etc.)
- Stereo sound system
- Teletext
- Headphone connection
- Automatic programming system
- Manual tuning
- Automatic power down after up to eight hours.
- Sleep timer
- Child lock
- Automatic sound mute when no transmission.
- NTSC playback
- AVL (Automatic Volume Limiting)
- PLL (Frequency Search)
- PC input
- Game Mode (Optional)
- Picture off function
- Programme recording
- Programme timeshifting
- Pixellence
- Ethernet (LAN) for Internet connectivity and service
- 802.11n WIFI Support via USB dongle
- Audio Video Sharing

Functions and features may vary in accordance with the model.

Notification (depending on the model)

TRADEMARK ACKNOWLEDGMENT

Manufactured under license from Dolby Laboratories. Dolby and the double-D symbol are trademarks of Dolby Laboratories.



The terms HDMI and High-Definition Multimedia Interface, and the HDMI Logo are trademarks or registered trademarks of HDMI Licensing LLC in the United States and other countries.



YouTube and the YouTube logo are trademarks of Google Inc.

For DTS patents, see <http://patents.dts.com>. Manufactured under license from DTS Licensing Limited. DTS, the Symbol, & DTS and the Symbol together are registered trademarks, and DTS TruSurround is a trademark of DTS, Inc.® DTS, Inc. All Rights Reserved.



For DTS patents, see <http://patents.dts.com>. Manufactured under license from DTS Licensing Limited. DTS, DTS-HD, the Symbol, & DTS or DTS-HD and the Symbol together are registered trademarks of DTS, Inc.® DTS, Inc. All Rights Reserved.



Specification

TV Broadcasting	PAL BG/DK/II' SECAM BG/DK
Receiving Channels	VHF (BAND I/III) - UHF (BAND U) - HYPERBAND
Number of Preset Channels	1000 (without satellite) 10000 (with satellite)
Channel Indicator	On Screen Display
RF Aerial Input	75 Ohm (unbalanced)
Operating Voltage	220-240V AC, 50Hz.
Audio	German Nicam SRS TruSurround (depends on model) DTS TruSurround (depends on model)
Power Consumption (W)	Refer to back cover label
Operation temperature and operation humidity	0°C up to 40°C, 85% humidity max

Disposal information

Instructions for waste Disposal:

Packaging and packaging aids are recyclable and should principally be recycled. Packaging materials, such as foil bag, must be kept away from children. Batteries, including those which are heavy metal-free, should not be disposed of with household waste. Please dispose of used battery in an environmentally friendly manner. Find out about the legal regulations which apply in your area.

- Don't try to recharge batteries. Danger of explosion. Replace batteries only with the same or equivalent type.

Information for Users in European Union Countries

The mark shown on the right is in compliance with the Waste Electrical and Electronic Equipment Directive 2012/19/EU (WEEE). The mark indicates the requirement NOT to dispose the equipment including any spent or discarded batteries as unsorted municipal waste, but use the return and collection systems available. If the batteries or accumulators included with this equipment display the chemical symbol Hg, Cd, or Pb, then it means that the battery has a heavy metal content of more than 0.0005% Mercury, or more than 0.002% Cadmium or more than, 0.004% Lead.



1. **Standby:** Switches On / Off the TV
2. **TV:** Displays channel list / Switches among broadcast types / Switches to TV Source
3. **Volume +/-**
4. **Menu:** Displays TV menu
5. **OK:** Confirms user selections, holds the page (in TXT mode), views channel list (DTV mode)
6. **Back/Return:** Returns to previous screen, opens index page (in TXT mode)
7. **Internet:** Opens the portal page, where you can reach many web based applications
8. **My button 1 (*)**
9. **Source:** Shows all available broadcasts and content sources
10. **Coloured Buttons:** Follow the on-screen instructions for coloured button functions
11. **Language:** Switches between sound modes (analogue TV), displays and changes audio/subtitle language (digital TV, where available)
12. **Rapid reverse:** Moves frames backwards in media such as movies
13. **Pause:** Pauses the media being played, starts timeshift recording
14. **Record:** Records programmes
15. **Play:** Starts to play selected media
16. **Stop:** Stops the media being played
17. **Rapid advance:** Moves frames forward in media such as movies
18. **Subtitles:** Turns subtitles on and off (where available)
19. **Screen:** Changes the aspect ratio of the screen
20. **Text:** Displays teletext (where available), press again to superimpose the teletext over a normal broadcast picture (mix)
21. **Media browser:** Opens the media browsing screen
22. **EPG (Electronic programme guide):** Displays the electronic programme guide
23. **Exit:** Closes and exits from displayed menus or returns to previous screen
24. **Navigation buttons:** Helps navigate menus, content etc. and displays the subpages in TXT mode when pressed Right or Left
25. **Quick Menu:** Displays a list of menus for quick access
26. **Info:** Displays information about on-screen content, shows hidden information (reveal - in TXT mode)
27. **Programme +/-**
28. **Mute:** Completely turns off the volume of the TV
29. **Swap:** Quickly cycles between previous and current channels or sources
30. **Numeric buttons:** Switches the channel, enters a number or a letter in the text box on the screen.
31. **Netflix:** Launches the Netflix application.

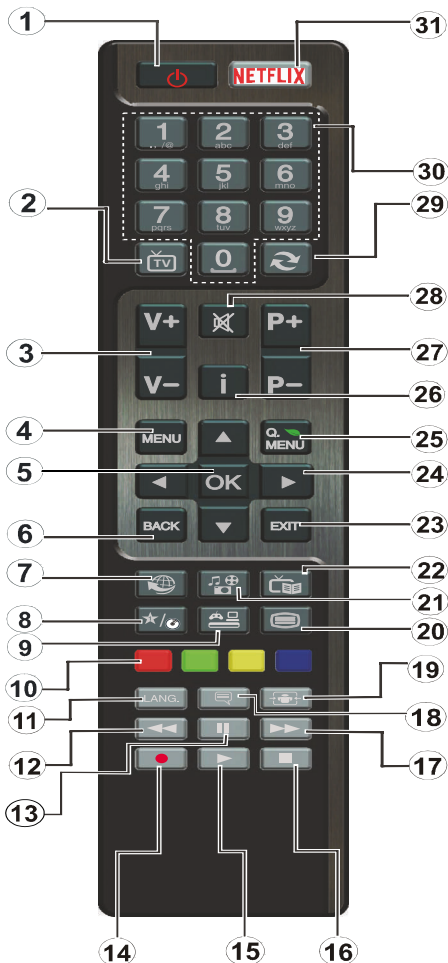

(*) MY BUTTON:

This button may have a default function depending on the model. However you can set a special function to this button by pressing on it for five seconds when on a desired source or channel. A confirmation message will be displayed on the screen. Now the MY BUTTON is associated with the selected function.

















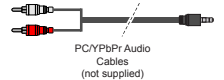

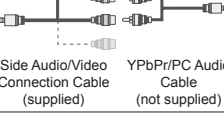











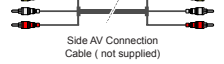

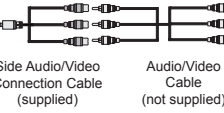





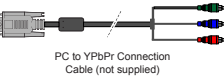

Note that if you perform First Time Installation, MY BUTTON will return to its default function.

Netflix: If this feature is supported by your TV, you can view your ESN(*) number and deactivate Netflix.

(*) ESN number is an unique ID number for Netflix, created especially to identify your TV.

Note: Functional button indications on some menu screens may vary in accordance with the remote control of your TV. Follow the button functions located at the bottom of the screen.

Connections (depending on the model)

Connector	Type	Cables	Device
	Scart Connection (back)		
	VGA Connection (back)		
SIDE AV 	PC/YPbPr Audio Connection (side)	 PC/YPbPr Audio Cables (not supplied)	
SIDE AV 	PC/YPbPr Audio Connection (side)	 Side Audio/Video Connection Cable (supplied) YPbPr/PC Audio Cable (not supplied)	
	HDMI Connection (back)		
SPDIF 	SPDIF (Coaxial Out) Connection (back)		
SPDIF 	SPDIF (Optical Out) Connection (back)		
SIDE AV 	Side AV (Audio/Video) Connection (side)	 Side AV Connection Cable (not supplied)	
SIDE AV 	Side AV (Audio/Video) Connection (side)	 Side Audio/Video Connection Cable (supplied) Audio/Video Cable (not supplied)	
HEADPHONE 	Headphone Connection (side)		
YPBPR 	YPbPr Video Connection (back)	 PC to YPbPr Connection Cable (not supplied)	
	USB Connection (side)		
	CI Connection (side)		
LAN 	Ethernet Connection (back)	 LAN / Ethernet Cable	
ANT. 	RF Input connects to an aerial or cable system. (depends on model)		
SAT 	Satellite (LNB) Input connects your TV to a satellite system. (depends on model)		

 **NOTE:** When connecting a device via the YPbPr or Side AV input, you must use the connection cables to enable connection. For Side AV input you should use the supplied cable. See the illustrations on the left side. | You can use YPbPr to VGA cable (not supplied) to enable YPbPr signal via VGA input. | You cannot use VGA and YPbPr at the same time. | To enable PC/YPbPr audio, you will need to use the Side AV input with a YPbPr/PC audio cable (not supplied) for audio connection, using the supplied Side AV connection cable's RED and WHITE inputs. | If an external device is connected via the SCART socket, the TV will automatically switch to AV mode. | When receiving DTV channels (Mpeg4 H.264) or while in Media Browser mode, output will not be available via the scart socket. | When using the wall mounting kit (available from third party in the market, if not supplied), we recommend that you plug all your cables into the back of the TV before mounting on the wall. | Insert or remove the CI module only when the TV is SWITCHED OFF. You should refer to the module instruction manual for details of the settings. | The/Each USB input of your TV supports devices up to 500mA. Connecting devices that have current value above 500mA may damage your TV. | By connecting an HDMI cable to your TV, you have to use only a shielded HDMI cable to guarantee a sufficient immunity against parasitic frequency radiation.

 If you want to connect a device to the TV, make sure that both the TV and the device are turned off before making any connection. After the connection is done, you can turn on the units and use them.

TV and Operating Buttons (depending on the model)



Standby/On

TV/AV

Source

-P/CH+

Programme +/-

-▲|

Volume +/-

Note: Press “-▲” and “▲+” buttons at the same time to view main menu.

-or-

1. Up direction
2. Down direction
3. Programme/ Volume / AV / Standby-On selection switch

Note: You can move the switch, upward or downward to change the volume. If you want to change channels, press the middle of the switch once (Position 3) and then move upward or downward. If you press the middle of the switch once more, source OSD will be displayed. If you press the middle of the switch and hold about a few seconds, the TV will switch to standby mode. Main menu OSD cannot be displayed via control buttons.

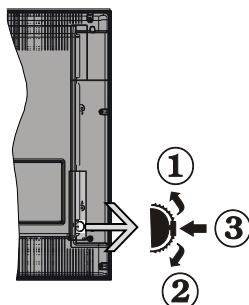

-or-

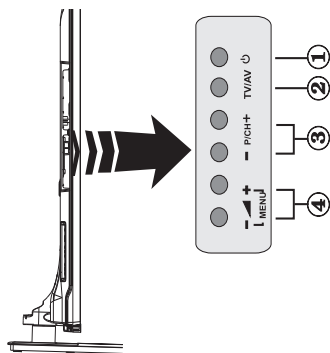

1. Standby On/Off button
2. TV/AV button
3. Programme Up/Down buttons
4. Volume Up/Down buttons

Power Connection

After unpacking, allow the TV set to reach the ambient room temperature before you connect the set to the mains.

Power Cable Connection:

IMPORTANT: The TV set is designed to operate on 220-240V AC, 50 Hz socket.

Plug the power cable to the mains socket outlet. Leave at least 10mm space around the TV set.

Antenna Connection (depending on the model)

Connect the aerial or cable TV plug to the AERIAL INPUT (ANT) socket or satellite plug to the SATELLITE INPUT (LNB) socket located on the back of the TV.

Satellite and Cable connection are dependent on the model.

USB Connection

You can connect USB devices to your TV by using the USB inputs of the TV. This feature allows you to display/play JPG, MP3 and video files stored in a USB stick. It is possible that certain types of USB devices (e.g. MP3 Players) may not be compatible with this TV. You should back up your files before making any connections to the TV set in order to avoid any possible data loss. Note that manufacturer will not be responsible for any file damage or data loss. Do not pull out USB module while playing a file.

CAUTION: Quickly plugging and unplugging USB devices, is a very hazardous operation. Especially, do not repeatedly quickly plug and unplug the drive. This may cause physical damage to the USB player and especially the USB device itself.

Side View Usb Memory

Second USB is optional, depending on the model.

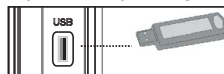

IMPORTANT: The TV should be switched off while plugging or unplugging a USB device. Plug your USB devices to the USB input of the TV. You can connect a usb device to your TV by using the USB input of the TV.

Note: It is possible certain types of hard disk drives are not supported.

Installing the Batteries to the Remote

Lift the cover on the back of the remote gently. Insert two AAA batteries. Make sure the (+) and (-) signs match (observe correct polarity). Place the cover back on. Remote range is approximately 7m/23ft.

Environmental Information

This television is designed to be environment friendly. To reduce energy consumption, you can follow these steps:

If you set the **Energy Saving to Minimum, Medium, Maximum** or **Auto** the TV will reduce the energy consumption accordingly. If you like to set the **Backlight** to a fixed value set as **Custom** and adjust the **Backlight** (located under the **Energy Saving** setting) manually using Left or Right buttons on the remote. Set as **Off** to turn this setting off.

*Note: Available **Energy Saving** options may differ depending on the selected **Mode** in the **System>Picture** menu.*

The **Energy Saving** settings can be found in the **System>Picture** menu. Note that some picture settings will be unavailable to be changed.

If pressed Right button while **Auto** option is selected or Left button while **Custom** option is selected, "**Screen will be off in 15 seconds.**" message will be displayed on the screen. Select **Proceed** and press **OK** to turn the screen off immediately. If you don't press any button, the screen will be off in 15 seconds. Press any button on the remote or on the TV to turn the screen on again.

*Note: **Screen Off** option is not available if the Mode is set to **Game**.*

When the TV is not in use, please switch off or disconnect the TV from the mains plug. This will also reduce energy consumption.

Standby Notifications

If the TV does not receive any input signal (e.g. from an aerial or HDMI source) for 5 minutes, it will go into standby. When you next switch-on, the following message will be displayed: "**TV switched to stand-by mode automatically because there was no signal for a long time.**" Press **OK** to continue.

If the TV is on and it isn't being operated for a while it will go into standby. When you next switch-on, the following message will be displayed. "**TV switched to stand-by mode automatically because no operation was made for a long time.**" Press **OK** to continue.

Switching On/Off (depending on the model)

To Switch the TV On

- Connect the power cord to the 220-240V AC, 50 Hz.
- Then the standby LED lights up.

To switch on the TV from standby mode either:

- Press the **Standby** button, **Programme +/-** or a numeric button on the remote control.

Control buttons on the TV (depending on model)

- Press the **Standby** button or **Programme +/-** button on the TV. The TV will then switch on.

-or-

- Press and hold the middle of the control switch on the left side of the TV until the TV comes on from standby. The TV will then switch on.

To Switch the TV Off (depending on model)

- Press the **Standby** button on the remote control or press the **Standby** button on the TV or press and hold the control switch on the TV until shut down, so the TV switches into standby mode (depends on the model).
- **To power down the TV completely, unplug the power cord from the mains socket.**

*Note: When the TV is switched into standby mode, standby LED can blink to indicate that features such as **Standby Search**, **Over Air Download** or **Timer** is active. The LED can also blink when you switch on the TV from standby mode.*

First Time Installation (depending on the model)

When turned on for the first time, the language selection screen is displayed. Select the desired language and press **OK**.

On the next screen, set your preferences using the directional buttons.

*Note: Depending on the **Country** selection you may be asked to set and confirm a PIN at this point. The selected PIN cannot be 0000. You have to enter it if you are asked to enter a PIN for any menu operation later.*

About Selecting Broadcast Type

Aerial: If **Aerial** broadcast search option is turned on, the TV will search for digital terrestrial broadcasts after other initial settings are completed.

Cable (depending on model): If **Cable** broadcast search option is turned on, the TV will search for digital cable broadcasts after other initial settings are completed. According to your other preferences a confirmation message may be displayed before starting to search. Select **YES** and press **OK** to proceed. To cancel operation, select **NO** and press **OK**. You can select **Network** or set values such as **Frequency**, **Network ID** and **Search Step**. When finished, press **OK** button.

*Note: Searching duration will change depending on the selected **Search Step**.*

Satellite (depending on model): If **Satellite** broadcast search option is turned on, the TV will search for digital satellite broadcasts after other initial settings are completed. Before satellite search is performed some settings should be made. **Antenna Type** menu will be displayed first. You can select **Antenna Type** as **Direct**, **Single Satellite Cable** or **DiSeqC switch** by using "**◀**" or "**▶**" buttons.

- **Direct:** If you have a single receiver and a direct satellite dish, select this antenna type. Press **OK** to

continue. Select an available satellite on the next screen and press **OK** to scan for services.

- **Single Satellite Cable:** If you have multiple receivers and a single satellite cable system, select this antenna type. Press **OK** to continue. Configure settings by following instructions on the next screen. Press **OK** to scan for services.
- **DiSEqC switch:** If you have multiple satellite dishes and a **DiSEqC switch**, select this antenna type. Press **OK** to continue. You can set four **DiSEqC** options (if available) on the next screen. Press **OK** button to scan the first satellite in the list.

Analogue: If **Analogue** broadcast search option is turned on, the TV will search for analogue broadcasts after other initial settings are completed.

Additionally you can set a broadcast type as your favourite one. Priority will be given to the selected broadcast type during the search process and the channels of it will be listed on the top of the **Channel List**. When finished, press **OK** to continue.

You can activate **Store Mode** option at this point. This option will configure your TV's settings for store environment and depending on the TV model being used, the supported features of it may be displayed on the top of the screen as an info banner. This option is intended only for store use. It is recommended to select **Home Mode** for home use. This option will be available in **System>More** menu and can be turned off/on later.

Press **OK** button on the remote control to continue and the **Network/Internet Settings** menu will be displayed. Please refer to **Connectivity** section to configure a wired or a wireless connection. After the settings are completed press **OK** button to continue. To skip to the next step without doing anything press the **Rapid advance** button on the remote.

After the initial settings are completed TV will start to search for available broadcasts of the selected broadcast types.

After all the available stations are stored, scan results will be displayed. Press **OK** to continue. The **Edit Channel List** menu will be displayed next. You can edit the channel list according to your preferences or press the **Menu** button to quit and watch TV.

While the search continues a message may appear, asking whether you want to sort channels according to the LCN(*). Select **Yes** and press **OK** to confirm.

(* LCN is the Logical Channel Number system that organizes available broadcasts in accordance with a recognizable channel number sequence (if available).

Note: Do not turn off the TV while initializing first time installation. Note that, some options may not be available depending on the country selection.

Using SatcoDX Feature (depending on the model)

You can perform SatcoDX operations using the **Installation>Satellite Settings** menu. In the **SatcoDX** menu, there are two options regarding to the SatcoDx.

You can download or upload SatcoDX data. In order to perform these functions a USB device must be connected to the TV.

You can upload current services and related satellites & transponders in TV, to a USB device.

Additionally you can download one of the SatcoDx files stored in USB device, to the TV.

When you select one of these files, all services and related satellites and transponders in the selected file will be stored in the TV. If there are any installed terrestrial, cable and/or analog services, they will be kept and only satellite services will be removed.

Afterwards, check your antenna settings and make changes if necessary. An error message stating "**No Signal**" may be displayed if the antenna settings are not configured properly.

Media Playback via USB Input

You can connect 2.5" and 3.5" inch (hdd with external power supply) external hard disk drives or USB memory stick to your TV by using the USB inputs of the TV.

IMPORTANT! Back up the files on your storage devices before connecting them to the TV. Manufacturer will not be responsible for any file damage or data loss. Certain types of USB devices (e.g. MP3 Players) or USB hard disk drives/memory sticks may not be compatible with this TV. The TV supports FAT32 and NTFS disk formatting but recording will not be available with NTFS formatted disks.

While formatting USB hard drives which have more than 1TB (Tera Byte) storage space you may experience some problems in the formatting process.

Wait a little while before each plugging and unplugging as the player may still be reading files. Failure to do so may cause physical damage to the USB player and the USB device itself. Do not pull out your drive while playing a file.

You can use USB hubs with your TV's USB inputs. External power supplied USB hubs are recommended in such a case.

It is recommended to use the TV's USB input(s) directly, if you are going to connect a USB hard disk.

Note: When viewing image files the Media Browser menu can only display 1000 image files stored on the connected USB device.

Timeshift Recording

Press **Pause** button while watching a broadcast to activate timeshifting mode. In timeshifting mode, the programme is paused and simultaneously recorded to the connected USB disk.

Press **Play** button again to resume the paused programme from where you stopped. Press the **Stop** button to stop timeshift recording and return to the live broadcast.

Timeshift cannot be used while in radio mode.

You cannot use the timeshift fast reverse feature before advancing the playback with the fast forward option.





Instant Recording

Press **Record** button to start recording an event instantly while watching a programme. You can press **Record** button on the remote control again to record the next event on the EPG. In this case, an OSD will be displayed, indicating the programmed events for recording. Press **Stop** button to cancel instant recording.

You can not switch broadcasts or view the media browser during the recording mode. While recording a programme or during the timeshifting, a warning message appears on the screen if your USB device speed is not sufficient.

Media Browser Menu

You can play photo, music and movie files stored on a USB disk by connecting it to your TV. Connect a USB disk to one of the USB inputs located on the side of the TV. Pressing the **Menu** button while in the **Media Browser** mode will access the **Picture**, **Sound** and **Settings** menu options. Pressing the **Menu** button again will exit from this screen. You can set your **Media Browser** preferences by using the **Settings** Menu.

<i>Loop/Shuffle Mode Operation</i>	
Start playback with the Play button and activate 	All files in the list will be continuously played in original order
Start playback with the OK button and activate 	The same file will be played continuously (repeat)
Start playback with the Play button and activate 	All files in the list will be played once in random order
Start playback with the Play button and activate  	All files in the list will be continuously played in the same random order.

Recording a Programme

IMPORTANT: When using a new USB hard disk drive, it is recommended that you first format the disk using your TV's "**Format Disk**" option.

To record a programme, you should first connect a USB disk to your TV while the TV is switched off. You should then switch on the TV to enable the recording feature.

To use recording your USB drive should have 2 GB free space and be USB 2.0 compatible. If the USB drive is not compatible an error message will be displayed.

To record long duration programmes such as movies, it is recommended to use USB Hard disk drives (HDD's).

Recorded programmes are saved into the connected USB disk. If desired, you can store/copy recordings onto a computer; however, these files will not be available to be played on a computer. You can play the recordings only via your TV.

Lip Sync delay may occur during the timeshifting. Radio record is supported. The TV can record programmes up to ten hours.

Recorded programmes are split into 4GB partitions. If the writing speed of the connected USB disk is not sufficient, the recording may fail and the timeshifting feature may not be available.

It is recommended to use USB hard disk drives for recording HD programmes.

Do not plug out the USB/HDD during a recording. This may harm the connected USB/HDD.

If the AC cord is unplugged while there is an active USB-recording timer setting, it will be cancelled.

Multipartition support is available. A maximum of two different partitions are supported. The first partition of the USB disk is used for PVR ready features. It also must be formatted as the primary partition to be used for the PVR ready features.

Some stream packets may not be recorded because of signal problems, as a result sometimes videos may freeze during playback.

Record, Play, Pause, Display (for PlayListDialog) keys can not be used when teletext is on. If a recording starts from timer when teletext is on, teletext is automatically turned off. Also teletext usage is disabled when there is an ongoing recording or playback.

Watching Recorded Programmes

Select **Recordings** from the **Media Browser** menu. Select a recorded item from the list (if previously recorded). Press the **OK** button to view the **Play Options**. Select an option then press **OK** button.

Note: *Viewing main menu and menu items will not be available during the playback.*

Press the **Stop** button to stop a playback and return to the **Recordings**.

Slow Forward

If you press **Pause** button while watching recorded programmes, the slow forward feature will be available. You can use **Rapid advance** button to slow forward. Pressing **Rapid advance** button consecutively will change slow forwarding speed.

Recording Configuration

Select the **Recording Configuration** item in the **Media Browser>Settings** menu to configure the recording settings.

Format Disk: You can use the **Format Disk** feature for formatting the connected USB disk. Your pin is required to use the **Format Disk** feature.

Note: *Default PIN can be set to 0000 or 1234. If you have defined the PIN(is requested depending on the country selection) during the **First Time Installation** use the PIN that you have defined.*

IMPORTANT: Formatting your USB drive will erase ALL the data on it and it's file system will be converted to FAT32. In most cases operation errors will be fixed after a format but you will lose ALL your data.

If "USB disk writing speed too slow to record" message is displayed on the screen while starting a recording, try restarting the recording. If you still get the same error, it is possible that your USB disk does not meet the speed requirements. Try connecting another USB disk.

FollowMe TV (depending on the model)

With your mobile device you can stream the current broadcast from your smart TV using the **FollowMe TV** feature. Install the appropriate Smart Center application to your mobile device. Start the application. For further information on using this feature refer to the instructions of the application you use.

Note: *This application may not be compatible with all mobile devices. HD channels are not supported and both of the devices must be connected to the same network.*

CEC and CEC RC Passthrough (depending on the model)

This function allows to control the CEC-enabled devices, that are connected through HDMI ports by using the remote control of the TV.

The **CEC** option in the **System>More** menu should be set as **Enabled** at first. Press the **Source** button and

select the HDMI input of the connected CEC device from the **Source List** menu. When new CEC source device is connected, it will be listed in source menu with its own name instead of the connected HDMI ports name(such as DVD Player, Recorder 1 etc.).

The TV remote is automatically able to perform the main functions after the connected HDMI source has been selected.

To terminate this operation and control the TV via the remote again, press **Quick Menu** button on the remote, highlight the **CEC RC Passthrough** and set as **Off** by pressing Left or Right button. This feature can also be enabled or disabled under the **System>More** menu.

The TV supports also ARC(Audio Return Channel) feature. This feature is an audio link meant to replace other cables between the TV and the audio system (A/V receiver or speaker system).

When ARC is active, TV does not mute its other audio outputs automatically. So you need to decrease TV volume to zero manually, if you want to hear audio from connected audio device only (same as other optical or co-axial digital audio outputs). If you want to change connected device's volume level, you should select that device from the source list. In that case volume control keys are directed to connected audio device.

System Audio Control

Allows an Audio Amplifier/Receiver to be used with the TV. The volume can be controlled using the remote control of the TV. To activate this feature set the **Speakers** option in the **System>More** menu as **Amplifier**. The TV speakers will be muted and the sound of the watched source will be provided from the connected sound system.

Note: *The audio device should support System Audio Control feature and CEC option should be set as **Enabled**.*

E-Manual (depending on the model)

You can find instructions for your TV's features in the E-Manual.

To use E-Manual, press to the **Info** button while main menu is displayed on the screen or press **Quick Menu** button, select **Information Booklet** and press **OK**.

By using the directional buttons select a desired category. Every category includes different topics. Select a topic and press **OK** to read instructions.

To close the E-Manual screen press the **Exit** or **Menu** button.

Note: *The contents of the E-Manual may vary according to the model.*

General TV Operation

Using the Channel List

The TV sorts all stored stations in the **Channel List**. You can edit this channel list, set favourites or set active stations to be listed by using the **Channel List** options. Press the **OK/TV** button to open the **Channel List**. You can filter the listed channels by pressing the **Blue** button or open the **Edit Channel List** menu by pressing the **Green** button in order to make advanced changes in the current list.

Managing the Favourite Lists

You can create four different lists of your favourite channels. Enter the **Channel List** in the main menu or press the **Green** button while the **Channel List** is displayed on the screen in order to open the **Edit Channel List** menu. Select the desired channel on the list. You can make multiple choices by pressing the **Yellow** button. Then press the **OK** button to open the **Channel Edit Options** menu and select **Add/Remove Favourites** option. Press the **OK** button again. Set the desired list option to **On**. The selected channel/s will be added to the list. In order to remove a channel or channels from a favourite list follow the same steps and set the desired list option to **Off**.

You can use the **Filter** function in the **Edit Channel List** menu to filter the channels in the **Channel list** permanently according to your preferences. Using this **Filter** option, you can set one of your four favourite lists to be displayed everytime the **Channel list** is opened. The filtering function in the **Channel list** menu will only filter the currently displayed **Channel list** in order to find a channel and tune in to it. These changes will not remain the next time the **Channel list** is opened if you don't save them. To save the changes on the list press the **Red** button after filtering while the **Channel list** is displayed on the screen.

Configuring Parental Settings

To prohibit viewing of certain programmes, channels and menus can be locked by using the parental control system.

To display parental lock menu options, the PIN number should be entered. After coding the correct PIN number, **Parental Settings** menu will be displayed.

Menu Lock: Menu lock setting enables or disables the menu access.

Maturity Lock: If this option is set, TV gets the maturity information from the broadcast and if this maturity level is disabled, disables access to the broadcast.

Note: If the country option in the First Time Installation is set as France, Italy or Austria, Maturity Lock's value will be set to 18 as default.

Child Lock: When Child Lock is set, the TV can only be controlled by the remote control. In this case the control panel buttons will not work.

Internet Lock: If this option is set to **OFF**, the open browser application in the portal will be disabled. Set to **ON** to release the application again.

Set PIN: Defines a new PIN number.

Default CICAM PIN: This option will appear as greyed out if no CI module is inserted into the CI slot of the TV. You can change the default PIN of the CI CAM using this option.

Note: Default PIN can be set to 0000 or 1234. If you have defined the PIN(is requested depending on the country selection) during the First Time Installation use the PIN that you have defined.

Some options may not be available depending on the country selection in the First Time Installation.

Electronic Programme Guide (EPG)

Some channels send information about their broadcast schedules. Press the **Epg** button to view the **Programme Guide** menu.

There are 3 different types of schedule layouts available, **Timeline Schedule**, **List Schedule** and **Now/Next Schedule**. To switch between them follow the instructions on the bottom of the screen.

Timeline Schedule

Zoom (Yellow button): Press the **Yellow** button to see events in a wider time interval.

Filter (Blue button): Views filtering options.

Select Genre (Subtitles button): Displays **Select Genre** menu. Using this feature, you can search the programme guide database in accordance with the genre. Info available in the programme guide will be searched and results matching your criteria will be highlighted.

Options (OK button): Displays event options.

Event Details (Info button): Displays detailed information about selected events.

Next/Prev Day (Programme +/- buttons): Displays the events of previous or next day.

Search (Text button): Displays **Guide Search** menu.

Now (Swap button): Displays current event of the highlighted channel.

Rec./Stop (Record button): The TV will start to record the selected event. You can press again to stop the recording.

IMPORTANT: Connect a USB disk to your TV while the TV is switched off. You should then switch on the TV to enable the recording feature.

Note: Switching to a different broadcast or source is not available during a recording.

List Schedule(*)

() In this layout option, only the events of the highlighted channel will be listed.*

Prev. Time Slice (Red button): Displays the events of previous time slice.

Next/Prev Day (Programme +/- buttons): Displays the events of previous or next day.

Event Details (Info button): Displays detailed information about selected events.

Filter (Text button): Views filtering options.

Next Time Slice (Green button): Displays the events of next time slice.

Options (OK button): Displays event options.

Rec./Stop (Record button): The TV will start to record the selected event. You can press again to stop the recording.

IMPORTANT: Connect a USB disk to your TV while the TV is switched off. You should then switch on the TV to enable the recording feature.

Note: Switching to a different broadcast or source is not available during a recording.

Now/Next Schedule

Options (OK button): Displays event options.

Event Details (Info button): Displays detailed information about selected events.

Filter (Blue button): Views filtering options.

Rec./Stop (Record button): The TV will start to record the selected events. You can press again to stop the recording.

IMPORTANT: Connect a USB disk to your TV while the TV is switched off. You should then switch on the TV to enable the recording feature.

Note: Switching to a different broadcast or source is not available during a recording.

Event Options

Use the directional buttons to highlight an event and press **OK** button to display **Event Options** menu. The following options are available.

Select Channel: Using this option, you can switch to the selected channel.

Record / Delete Rec. Timer: Select the **Record** option and press the **OK** button. If the event is going to be broadcasted at a future time, it will be added to **Timers** list to be recorded. If the selected event is being broadcasted at the moment, recording will start immediately.

To cancel an already set recording, highlight that event and press the **OK** button and select the option **Delete Rec. Timer**. The recording will be cancelled.

Set Timer on Event / Delete Timer on Event: After you have selected an event in the EPG menu, press the **OK** button. Select **Set Timer on Event** option and press the **OK** button. You can set a timer for future events. To cancel an already set timer, highlight that event and press the **OK** button. Then select **Delete Timer on Event** option. The timer will be cancelled.

Notes: You cannot switch to any other channel or source while there is an active recording or timer on the current channel.

It is not possible to set timer or record timer for two or more individual events at the same time interval.

Software Upgrade

Your TV is capable of finding and updating automatically via the broadcast signal or via Internet.

Software upgrade search via user interface

On the main menu select **System** and then **More**. Navigate to **Software Upgrade** and press **OK** button. In **Upgrade Options** menu select **Scan for upgrade** and press **OK** button to check for a new software upgrade.

If a new upgrade is found, it starts to download the upgrade. After the download is completed confirm the question asking about rebooting the TV by pressing the **OK** to continue with the reboot operation.

3 AM search and upgrade mode

Your TV will search for new upgrades at 3:00 o'clock if **Automatic scanning** option in the **Upgrade Options** menu is **Enabled** and if the TV is connected to an aerial signal or to Internet. If a new software is found and downloaded successfully, it will be installed at the next power on.

Note: Do not unplug the power cord while led is blinking during the reboot process. If the TV fails to come on after the upgrade, unplug, wait for two minutes then plug it back in.

Troubleshooting & Tips

Tv will not turn on

Make sure the power cord is plugged in securely to wall outlet. Check if batteries are exhausted. Press the Power button on the TV.

Poor picture

- Check if you have selected the correct TV system.
- Low signal level can cause picture distortion. Please check antenna access.
- Check if you have entered the correct channel frequency if you have done manual tuning.
- The picture quality may degrade when two devices are connected to the TV at the same time. In such a case, disconnect one of the devices.

No picture

- This means your TV is not receiving any transmission. Make sure the correct source has been selected.
- Is the antenna connected properly?
- Is the antenna cable damaged?
- Are suitable plugs used to connect the antenna?
- If you are in doubt, consult your dealer.

No sound

- Check if the TV is muted. Press the **Mute** button or increase the volume to check.

- Sound may be coming from only one speaker. Check the balance settings from sound menu.

Remote control - no operation

- The batteries may be exhausted. Replace the batteries.

Input sources - can not be selected

- If you cannot select an input source, it is possible that no device is connected. If not;
- Check the AV cables and connections if you have tried to connect a device.

Recording unavailable

To record a programme, you should first connect a USB disk to your TV while the TV is switched off. You should then switch on the TV to enable recording feature. If you cannot record, try switching off the TV and then re-inserting the USB device.

USB is too slow

If a “USB disk writing speed too slow to record” message is displayed on the screen while starting a recording, try restarting the recording. If you still get the same error, it is possible that your USB disk does not meet the speed requirements. Try connecting another USB disk.

Connectivity Functions (depending on the model)

To configure wired/wireless settings please refer to the **Network Settings** section in the **System>Options** Menu.

Connecting TV to a Home Network

Connectivity feature allows the TV to connect to the home network wired or wirelessly. You can use this networking system to connect to the Internet Portal or to access photo, video and audio files that are stored on a media server connected to the network and play/display them on the TV.

Wired connection

Connect the TV to the modem/router via a LAN cable (not supplied). Select **Network Type** as **Wired Device** in **Network Settings** menu.

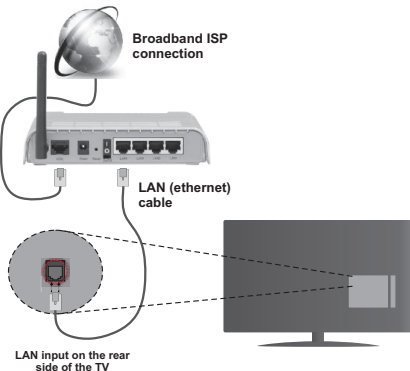

Wireless connection

IMPORTANT: If your TV does not have built-in wifi feature, “Veezy 200” USB dongle is required to use wireless network features.

To connect the TV to the home network wirelessly just select **Network Type** as **Wireless Device** in **Network Settings** menu. The TV will search for available networks. Select the desired network and press **OK**. If the TV has a built-in WLAN system there is no need for additional devices to connect to a wireless network.

For models with built-in WLAN system:

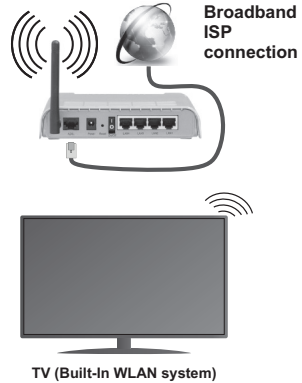

For models without built-in WLAN system:

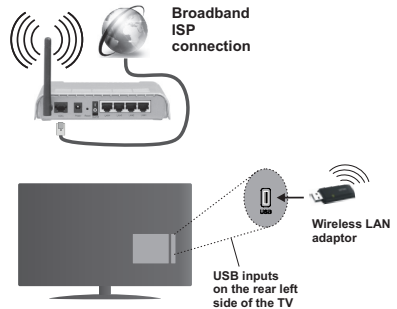

About Using Connectivity Feature

PC/HDD/Media Player or any other devices that are compatible should be used with wired connection for higher playback quality.

Install Nero Media Home software (<http://www.nero.com/mediahome-tv>) to your PC to use it as a media server.

For models without built-in wifi system, connect the wireless adaptor to one of the USB inputs of the TV.

While using the wireless connection type, consider that the TV cannot connect to the networks with hidden SSID.

Configuring Network Settings

Your TV's network settings include wired and wireless connection options. If you are connecting the TV via ethernet input, select **Network Type** as **Wired Device**. Select **Wireless Device** option if you are going to connect the TV to your network wirelessly.

You can press **OK** button to scan available networks for wireless connection. Afterwards, a list of networks will be displayed. Select your network from the list and press **OK**.

If the selected network is protected with a password, enter the correct key by using the virtual keyboard.

Wait until the IP the address is shown on the screen. This means that the connection is now established.

To disconnect from a network, you should highlight **Network Type**, press Left or Right button and set as **Disabled**.

Connecting to your mobile device via WiFi

If your mobile device has WiFi feature, you can connect it to your TV via a router, in order to access the content in your device. For this, your mobile device must have an appropriate sharing software.

Connect your mobile device to the router/modem and then activate the sharing software on your mobile device. Then, select files that you want to share with your TV.

If the connection is established correctly, you will be able to access the shared files from your mobile device via the Media Browser of your TV.

Enter the Media Browser menu and the playback device selection OSD will be displayed. Select your mobile device and press the **OK** button to continue.

If available, you can download a virtual remote controller application from the server of your mobile device application provider. You can control the TV via your wireless handheld device using this application. To do this enable the **Virtual Remote** feature from the **System>Options>More** menu by pressing **Left** or **Right** button. Connect the TV and the mobile device to the same network and start the application.

Note: This feature may not be supported on all mobile devices.

Using Audio Video Sharing Network Service

Audio Video Sharing feature uses a standard that eases the viewing process of digital electronics and makes them more convenient to use on a home network.

This standard allows you to view and play photos, music and videos stored in the media server connected to your home network.

1. Nero Media Home Installation

The Audio Video Sharing feature cannot be used if the server programme is not installed onto your PC.

Please prepare your PC with the Nero Media Home programme.

2. Connect to a Wired or Wireless Network

See the **Wired/Wireless connection** chapters for detailed configuration information.

3. Play Shared Files via Media Browser

Select **Media Browser** by using the **directional** buttons from the main menu and press **OK**. The media browser will then be displayed.

Audio Video Sharing

Audio Video Sharing support is only available in the **Media Browser Folder** mode. To enable folder mode, go to the **Settings** tab in the main media browser screen and press **OK**. Highlight **View Style** and set to **Folder** using the **Left** or **Right** buttons. Select the desired media type and press **OK**.

If sharing configurations are set properly, **Device Selection** screen will be displayed after selecting the desired media type. If available networks are found, they will be listed on this screen. Select media server or network that you want to connect to using the Up or Down buttons and press **OK**. If you want to refresh the device list, press the **Green** button. You can press **Menu** to exit.

If you select the media type as **Videos** and choose a device from the selection menu. Then select the folder with video files in it on the next screen and all the available video files will be listed.

To play other media types from this screen, you must go back to main **Media Browser** screen and select the media type as desired and then perform the network selection again. Refer to the **Media Browser** menu section for further information on file playback.

Subtitle files do not work if you watch videos from your network through Audio Video Sharing feature.

You can connect only one television to the same network. If a problem occurs with the network, please switch your television off at the wall socket and back on again. Trick mode and jump are not supported with the Audio Video Sharing feature.

Note: There may be some PC's which may not be able to utilize the Audio Video Sharing feature due to administrator and security settings (such as business PC's).

For best home network streaming with this TV, the Nero software should be installed.

Wireless Display (depending on the model)

Wireless Display is a standard for streaming video and sound content by Wi-Fi Alliance. This feature provides the ability to use your TV as wireless display device.

Using with mobile devices

There are different standards which enable sharing of screens including graphical, video and audio content between your mobile device and TV.

Plug the wireless USB dongle to TV first, if the TV doesn't have internal WiFi feature.

Then press the **Source** button on the remote and switch to **Wireless Display** source.

A screen appears stating that the TV is ready for connection.

Open the sharing application on your mobile device. These applications are named differently for each brand, please refer to the instruction manual of your mobile device for detailed information.

Scan for devices. After you select your TV and connect, the screen of your device will be displayed on your TV.

Note: *This feature can be used only if the mobile device supports this feature. Scanning and connecting processes differ according to the programme you use. Android based mobile devices should have the software version V4.2.2 and above.*

Connecting Other Wireless Devices (depending on the model)

Your TV supports another short range wireless connection technology too. A pairing is required before using these kind of wireless devices with the TV set. You should do the followings to pair your device with the TV:

- Set the device to pairing mode
- Start device discovery on the TV

Note: *Refer to the user manual of the wireless device to learn how to set the device to pairing mode.*

You can connect audio devices or remote controllers wirelessly to your TV. Unplug or switch off any other connected audio device in order for wireless connection feature to work correctly. For audio devices you should use the **Audio Link** option in the **System>Sound** menu, for remote controllers the **Smart Remote** option in the **System>Settings>More** menu. Select the menu option and press the **OK** button to open the related menu. Using this menu you can discover and connect the devices that use the same wireless technology and start to use them. Follow the on-screen instructions. Start the device discovery. A list of available wireless devices will be displayed. Select the device you want to connect from the list and press the **OK** button to connect. If "**Device connected**" message is displayed, the connection

is successfully established. If the connection fails try it again.

Image transfer and audio streaming

You can also use this type of connection to transfer images or stream audio from your mobile device to your TV.

Pair the mobile device and the TV as described before. Start a device search in your hand-held device. Select your TV from listed devices. Confirm the request for connection on your TV screen and do the same on your hand held device screen. If no pairing is done, image transfer or audio streaming to the TV will not be possible.

The images sent by mobile device will be displayed on the TV without confirmation request, if the image file is suitable. You can also save the image file to a connected USB memory drive or set as boot logo, if this feature is supported and the file is suitable. Press the **Exit** button to terminate displaying the image.

The audio will be routed through the speakers of the TV, after confirmation is given. To start audio streaming unpair the device from your TV if it is paired with your TV previously. After pairing is completed, a confirmation message will be displayed asking whether you want to start audio streaming from your mobile device. Select **Yes** and press the **OK** button on the remote of the TV. If the connection is succeeded, all audio will be routed through the speakers of the TV. A symbol will appear on the upper side of the TV screen as long as the audio streaming connection is active. To terminate the audio streaming, you should turn off the wireless connection of your mobile device.

Close all running applications and all the menus on the TV for a trouble-free transfer. Only image files with sizes smaller than 5 MB and in the following file formats are suitable; *.jpg, .jpeg, .png, .bmp*. If a file sent by the mobile device does not suit these requirements, it will not be displayed on the TV.

Note: *Wireless devices may operate within the same radio frequency range and may interfere with one another. To improve the performance of your wireless device place it at least 1 meter away from any other wireless devices.*

Internet Portal

Portal feature adds your TV a feature that allows you to connect to a server on the Internet and view the content provided by this server over your Internet connection. Portal feature allows you to view the music, video, clip or web content with defined shortcuts. Whether you can view this content without interruption depends on the connection speed provided by your internet service provider.

Press "**Internet**" button on the remote to open internet portal page. You will see icons of the available applications and services on the portal screen. Use the navigation buttons on your remote to select the desired one. You may view the desired content by pressing OK after selecting. Press BACK/RETURN button to return back to the previous screen or EXIT to quit internet portal mode

Note: Possible application dependent problems may be caused by the content service provider.

Portal service content and the interface may be changed at any time without prior notice.

Open Browser (depending on the model)

Open Browser function is one of the applications on the portal that provides access to internet. Select the internet browser logo on the portal page and press **OK** to launch the browser. Logos of certain predefined websites will be displayed. You can select one of them for quick access or enter the URL-address of a website in the address bar on the top of the screen. To perform searches on the internet enter a keyword in the address dialog box and move the cursor to search icon using the navigation buttons on the remote and press **OK**

Smart Center (depending on the model)

Smart Center is a mobile application running on iOS and Android platforms. With your tablet or phone, you can easily stream your favourite live shows and programmes from your smart TV using its **FollowMe TV** technology. Also; you can launch your portal applications, use your tablet as a remote control for your TV and share media files.

To use Smart Center features, connections have to be done properly. Make sure the TV and mobile device are connected to the same network.

For media sharing feature **Audio Video Sharing** option in the **System>Options>More** menu of your TV should be enabled.

Download the appropriate Smart Center application onto your mobile device from the application store on the web and launch it to start to use.

Note: Being able to use all functions of this application depends on the features of your TV.

AV and HDMI Signal Compatibility

Source	Supported Signals		Available
EXT (SCART)	PAL		O
	SECAM		O
	NTSC4.43		O
	NTSC3.58		O
	RGB 50/60		O
Side AV	PAL		O
	SECAM		O
	NTSC4.43		O
	NTSC3.58		O
YPbPr	480i, 480p	60Hz	O
	576i, 576p	50Hz	O
	720p	50Hz,60Hz	O
	1080i	50Hz,60Hz	O
HDMI	480i, 480p	60Hz	O
	576i, 576p	50Hz	O
	720p	50Hz,60Hz	O
	1080i	50Hz,60Hz	O
	1080p	24Hz, 25Hz, 30Hz, 50Hz, 60Hz	O

(X: Not Available, O: Available)

In some cases a signal on the TV may not be displayed properly. The problem may be an inconsistency with standards from the source equipment (DVD, Set-top box, etc.). If you do experience such a problem please contact your dealer and also the manufacturer of the source equipment.

PC Input Typical Display Modes

The following table is an illustration of some of the typical video display modes. Your TV may not support all resolutions.

Index	Resolution	Frequency
1	640x350	85Hz
2	640x400	70Hz
3	640x480	60Hz
4	640x480	66Hz
5	640x480	72Hz
6	640x480	75Hz
7	640x480	85Hz
8	800x600	56Hz
9	800x600	60Hz
10	800x600	70Hz
11	800x600	72Hz
12	800x600	75Hz
13	800x600	85Hz
14	832x624	75Hz
15	1024x768	60Hz
16	1024x768	66Hz
17	1024x768	70Hz
18	1024x768	72Hz
19	1024x768	75Hz
20	1024x768	85Hz
21	1152x864	60Hz
22	1152x864	70Hz
23	1152x864	75Hz
24	1152x864	85Hz
25	1152x870	75Hz
26	1280x768	60Hz
27	1360x768	60Hz
28	1280x768	75Hz
29	1280x768	85Hz
30	1280x960	60Hz
31	1280x960	75Hz
32	1280x960	85Hz
33	1280x1024	60Hz
34	1280x1024	75Hz
35	1280x1024	85Hz
36	1400x1050	60Hz
37	1400x1050	75Hz
38	1400x1050	85Hz
39	1440x900	60Hz
40	1440x900	75Hz
41	1600x1200	60Hz
42	1680x1050	60Hz
43	1920x1080	60Hz
44	1920x1200	60Hz

Supported Video File Formats for USB Mode

Extension	Video Codec	SPEC (Resolution) & Bit Rate
.dat, vob	MPEG1/2	1080P@30fps - 40 Mbps
.mpg, .mpeg	MPEG1/2, MPEG4	
.ts, .trp, .tp	MPEG1/2, H.264, AVS, MVC	H.264: 1080Px2@30fps - 62.5 Mbps, 1080P@60fps - 62.5 Mbps MVC: 1080P@30fps - 62.5 Mbps Other: 1080P@30fps - 40Mbps
.mp4, .mov, .3gp, .3gp	MPEG1/2, MPEG4, H.263, H.264, Motion JPEG	H.264: 1080Px2@30fps - 62.5 Mbps, 1080P@60fps - 62.5 Mbps Motion JPEG: 640x480@30fps - 10 Mbps Other: 1080P@30fps - 40 Mbps
.avi	MPEG1/2, MPEG4, Sorenson H.263, H.263, H.264, WMV3, Motion JPEG	
.mkv	MPEG1/2, MPEG4, H.263, H.264, WMV3, Motion JPEG	
.asf	Sorenson H.263, H.264, WMV3, Motion JPEG	
.flv	WMV3	1080P@30fps - 40 Mbps
.swf	RV30/RV40	1080P@30fps - 40 Mbps
.wmv		

Supported Picture File Formats for USB Mode

Image	Photo	Resolution (width x height)	Remark
JPEG	Base-line	15360x8640	The limitation of max resolution depends on DRAM size
	Progressive	1024x768	
PNG	non-interlace	9600x6400	
	interlace	1200x800	
BMP		9600x6400	

Supported Audio File Formats for USB Mode

Extension	Audio Codec	Bit Rate	Sample rate
.mp3,	MPEG1/2 Layer1	32Kbps ~ 448Kbps	16KHz ~ 48KHz
	MPEG1/2 Layer2	8Kbps ~ 384Kbps	
	MPEG1/2 Layer3	8Kbps ~ 320Kbps	
.avi	MPEG1/2 Layer1	32Kbps ~ 448Kbps	16KHz ~ 48KHz
	MPEG1/2 Layer2	8Kbps ~ 384Kbps	
	MPEG1/2 Layer3	8Kbps ~ 320Kbps	
	AC3	32Kbps ~ 640Kbps	32KHz, 44.1KHz, 48KHz
	AAC, HEAAC		8KHz ~ 48KHz
	WMA	128bps ~ 320Kbps	8KHz ~ 48KHz
	WMA 10 Pro M0	< 192kbps	48KHz
	WMA 10 Pro M1	< 384kbps	48KHz
	WMA 10 Pro M2	< 768kbps	96KHz
	LPCM	64Kbps ~ 1.5Mbps	8KHz ~ 48KHz
.asf	IMA-ADPCM, MS-ADPCM	384Kbps	8KHz ~ 48KHz
	G711 A/mu-law	64Kbps ~ 128Kbps	8KHz
	MPEG1/2 Layer1	32Kbps ~ 448Kbps	16KHz ~ 48KHz
	MPEG1/2 Layer2	8Kbps ~ 384Kbps	
	MPEG1/2 Layer3	8Kbps ~ 320Kbps	
	WMA	128bps ~ 320Kbps	8KHz ~ 48KHz
	WMA 10 Pro M0	< 192kbps	48KHz
	WMA 10 Pro M1	< 384kbps	48KHz
	WMA 10 Pro M2	< 768kbps	96KHz
	.mkv, .mka	MPEG1/2 Layer1	32Kbps ~ 448Kbps
MPEG1/2 Layer2		8Kbps ~ 384Kbps	
MPEG1/2 Layer3		8Kbps ~ 320Kbps	
AC3		32Kbps ~ 640Kbps	32KHz, 44.1KHz, 48KHz
AAC, HEAAC			8KHz ~ 48KHz
WMA		128bps ~ 320Kbps	8KHz ~ 48KHz
WMA 10 Pro M0		< 192kbps	48KHz
WMA 10 Pro M1		< 384kbps	48KHz
WMA 10 Pro M2		< 768kbps	96KHz
VORBIS			Up to 48KHz
LPCM		64Kbps ~ 1.5Mbps	8KHz ~ 48KHz
IMA-ADPCM, MS-ADPCM		384Kbps	8KHz ~ 48KHz
G711 A/mu-law	64Kbps ~ 128Kbps	8KHz	
FLAC	< 1.6Mbps	8KHz ~ 96KHz	
.ts, .trp, .tp, .dat, .vob, .mpg, .mpeg	MPEG1/2 Layer1	32Kbps ~ 448Kbps	16KHz ~ 48KHz
	MPEG1/2 Layer2	8Kbps ~ 384Kbps	
	MPEG1/2 Layer3	8Kbps ~ 320Kbps	
	AC3	32Kbps ~ 640Kbps	32KHz, 44.1KHz, 48KHz
	EAC3	32Kbps ~ 6Mbps	32KHz, 44.1KHz, 48KHz
	AAC, HEAAC		8KHz ~ 48KHz
	LPCM	64Kbps ~ 1.5Mbps	8KHz ~ 48KHz

Extension	Audio Codec	Bit Rate	Sample rate
.wav	MPEG1/2 Layer1	32Kbps ~ 448Kbps	16KHz ~ 48KHz
	MPEG1/2 Layer2	8Kbps ~ 384Kbps	
	MPEG1/2 Layer3	8Kbps ~ 320Kbps	
	LPCM	64Kbps ~ 1.5Mbps	8KHz ~ 48KHz
	IMA-ADPCM, MS-ADPCM	384Kbps	8KHz ~ 48KHz
	G711 A/mu-law	64Kbps ~ 128Kbps	8KHz
.3gpp, .3gp, .mp4, .mov, .m4a	MPEG1/2 Layer3	8Kbps ~ 320Kbps	16KHz ~ 48KHz
	AC3	32Kbps ~ 640Kbps	32KHz, 44.1KHz, 48KHz
	EAC3	32Kbps ~ 6Mbps	32KHz, 44.1KHz, 48KHz
	AAC, HEAAC		8KHz ~ 48KHz
	VORBIS		Up to 48KHz
	LPCM	64Kbps ~ 1.5Mbps	8KHz ~ 48KHz
	IMA-ADPCM, MS-ADPCM	384Kbps	8KHz ~ 48KHz
	G711 A/mu-law	64Kbps ~ 128Kbps	8KHz
.flv	MPEG1/2 Layer3	8Kbps ~ 320Kbps	16KHz ~ 48KHz
	AAC, HEAAC		8KHz ~ 48KHz
.ac3	AC3	32Kbps ~ 640Kbps	32KHz, 44.1KHz, 48KHz
	AAC, HEAAC		8KHz ~ 48KHz
.swf	MPEG1/2 Layer3	8Kbps ~ 320Kbps	16KHz ~ 48KHz
.ec3	EAC3	32Kbps ~ 6Mbps	32KHz, 44.1KHz, 48KHz
.rm, .rmvb, .ra	AAC, HEAAC		8KHz ~ 48KHz
	LBR (cook)	6Kbps ~ 128Kbps	8KHz, 11.025KHz, 22.05KHz, 44.1KHz
.wma, .wmv	WMA	128bps ~ 320Kbps	8KHz ~ 48KHz
	WMA 10 Pro M0	< 192kbps	48KHz
	WMA 10 Pro M1	< 384kbps	48KHz
	WMA 10 Pro M2	< 768kbps	96KHz
.webm	VORBIS		Up to 48KHz

Supported Subtitle File Formats for USB Mode

Internal Subtitles		
Extension	Container	Subtitle Code
dat, mpg, mpeg, vob	MPG, MPEG	DVD Subtitle
ts, trp, tp	TS	DVB Subtitle
mp4	MP4	DVD Subtitle UTF-8 Plain Text
mkv	MKV	ASS SSA UTF-8 Plain Text VobSub DVD Subtitle

External Subtitles		
Extension	Subtitle Parser	Remark
.srt	Subrip	
.ssa/ .ass	SubStation Alpha	
.smi	SAMI	
.sub	SubViewer MicroDVD DVDSusbtitledSystem Subldx (VobSub)	SubViewer 1.0 & 2.0 Only
.txt	TMPlayer	

Supported DVI Resolutions

When connecting devices to your TV's connectors by using DVI converter cable(DVI to HDMI cable - not supplied), you can refer to the following resolution information.

	56Hz	60Hz	66Hz	70Hz	72Hz	75Hz
640x400				<input checked="" type="checkbox"/>		
640x480		<input checked="" type="checkbox"/>	<input checked="" type="checkbox"/>		<input checked="" type="checkbox"/>	<input checked="" type="checkbox"/>
800x600	<input checked="" type="checkbox"/>	<input checked="" type="checkbox"/>		<input checked="" type="checkbox"/>	<input checked="" type="checkbox"/>	<input checked="" type="checkbox"/>
832x624						<input checked="" type="checkbox"/>
1024x768		<input checked="" type="checkbox"/>	<input checked="" type="checkbox"/>	<input checked="" type="checkbox"/>	<input checked="" type="checkbox"/>	<input checked="" type="checkbox"/>
1152x864		<input checked="" type="checkbox"/>		<input checked="" type="checkbox"/>		<input checked="" type="checkbox"/>
1152x870						<input checked="" type="checkbox"/>
1280x768		<input checked="" type="checkbox"/>				<input checked="" type="checkbox"/>
1360x768		<input checked="" type="checkbox"/>				
1280x960		<input checked="" type="checkbox"/>				<input checked="" type="checkbox"/>
1280x1024		<input checked="" type="checkbox"/>				<input checked="" type="checkbox"/>
1400x1050		<input checked="" type="checkbox"/>				<input checked="" type="checkbox"/>
1440x900		<input checked="" type="checkbox"/>				<input checked="" type="checkbox"/>
1600x1200		<input checked="" type="checkbox"/>				
1680x1050		<input checked="" type="checkbox"/>				
1920x1080		<input checked="" type="checkbox"/>				

Internet Portal functionality information

The content and services available through the SmartVue portal are provided by third-party providers and may be altered, suspended or discontinued at any time without notice.

Hitachi is not responsible for any of the content or services and does not warrant the availability of or access to such content or services.

For information on a particular service or on any content, please visit the service/content provider's website. If you have any questions concerning, or problems with, any content or services then please contact the relevant service/content provider directly. Hitachi is not responsible for providing customer service in relation to content or services and accepts no liability in this regard.

DVB functionality information

This DVB receiver is only suitable for use in the country which it was designed to be used in.

Although this DVB receiver conforms to the latest DVB specifications at the time of manufacture, we cannot guarantee compatibility with future DVB transmissions due to changes that may be implemented in broadcast signals and technologies.

Some digital television functions may not be available in all countries.

We continually strive to improve our products; therefore, specifications may change without prior notice.

For advice on where to purchase accessories, please contact the store where you purchased your equipment.