

AWP10WE Shower radio (waterproof)

AKAI



- EN For more information see www.akai.eu
- NL Voor meer informatie zie www.akai.eu
- D Für weitere Informationen siehe www.akai.eu
- F Pour plus d'informations, veuillez consulter le site www.akai.eu
- E Para más información, visite www.akai.eu
- DK For mere information besøg www.akai.eu
- FI Lisätietoja löydät osoitteesta www.akai.eu



1 Check the contents

Controleer de inhoud
Kontrollieren Sie den Inhalt
Vérifiez le contenu
Revise el contenido
Kontroller indholdet
Tarkista sisältö

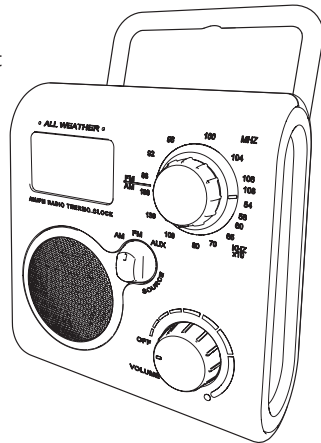

2 Place batteries

Plaats de batterijen
Legen Sie die Batterien ein
Placez les piles
Coloque las pilas
Sæt batteriet i
Paristojen asettaminen

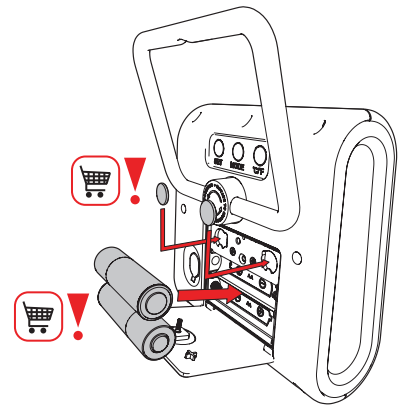
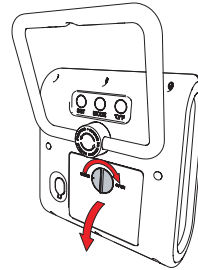

3 Place the device

Plaats het apparaat
Setzen Sie das Gerät ein
Placez l'appareil
Coloque el aparato
Anbring apparatet
Aseta laite

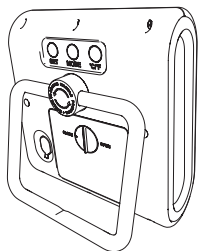
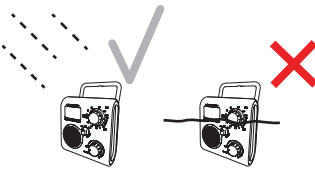

OR

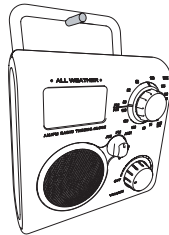

4 Switch on the AWP10WE

Zet de AWP10WE aan
Schalten Sie das AWP10WE ein
Mettez l' AWP10WE en service
Encienda el AWP10WE
Slut AWP10WE til
Kytke on AWP10WE

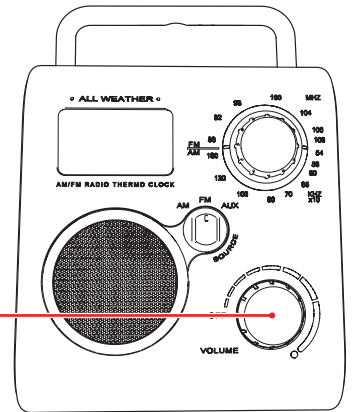
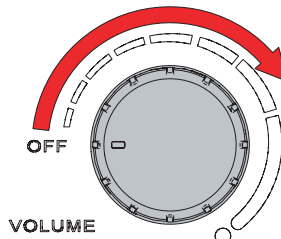

5 Select radio frequency

Kies frequentie
Wählen Sie die Frequenz
Sélectionnez la fréquence
Elija la emisora
Vælg frekvens
Valitse taajuus

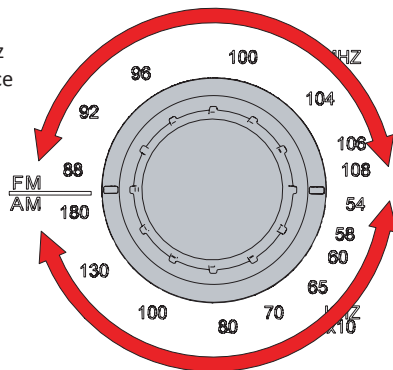
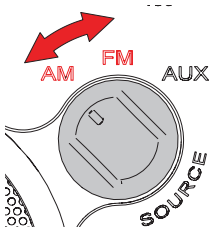

6 AUX connection

AUX aansluiting
Buchse AUX
Connexion AUX
Conexión auxiliar
AUX-tiislutning
AUX-liitäntä

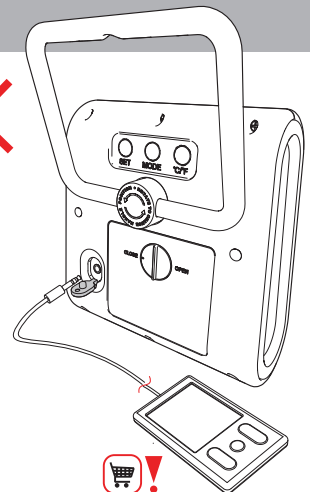
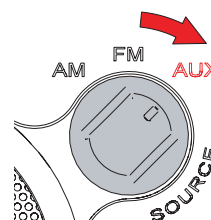

7

Temperature setting (°F/°C)

Temperatuur instelling (°F/°C)
 Temperatur-Einstellung (°F/°C)
 Réglage de la température (°F/°C)
 Ajuste de la temperatura (°F/°C)
 Temperaturindstilling (°F/°C)
 Lämpötila-asetus (°F/°C)

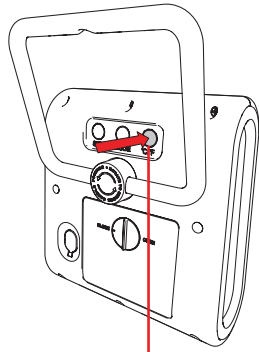

°C ↔ °F

8

Time mode and alarm mode

Tijd modus en alarm modus
 Zeitmodus und Alarmmodus
 Mode heure et mode alarme
 Modo hora y modo alarma
 Time-modus og alarmmodus
 Aikatila ja herätystila

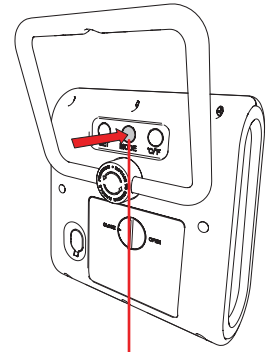

TIME MODE ↔ ALARM MODE

9

Set the clock

Stel de klok in
 Stellen Sie die Uhrzeit ein.
 Réglez l'horloge
 Ajuste el reloj
 Indstil uret
 Aseta aika

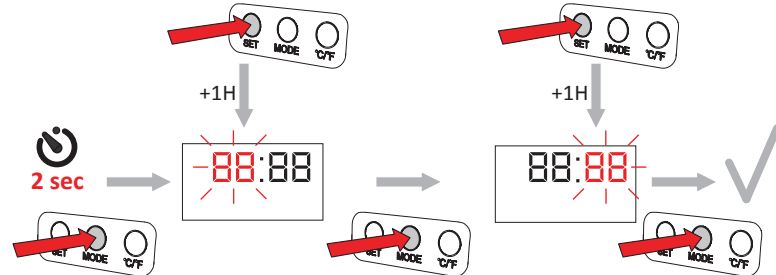

10

Switch between 12/24 o'clock

Wissel tussen 12/24 uur
 Wechsel zwischen 12/24 Stunden
 Changez format 12 ou 24 heures
 Cambiar entre 12/24 horas
 Skift mellem 12/24 timer
 Vaihda 12/24 tunnin näyttö

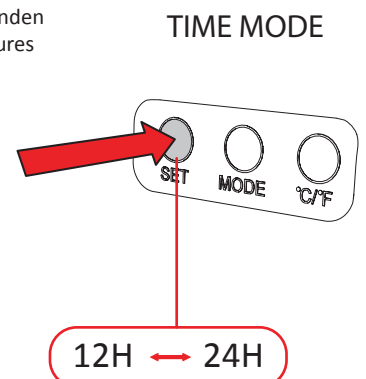

11

Setting the alarm time

De alarmtijd instellen
 Einstellen der Alarmzeit
 Réglage de l'heure de l'alarme
 Ajuste de la hora de alarma
 Alarmtidspunktet indstilles
 Säädä herätysaika

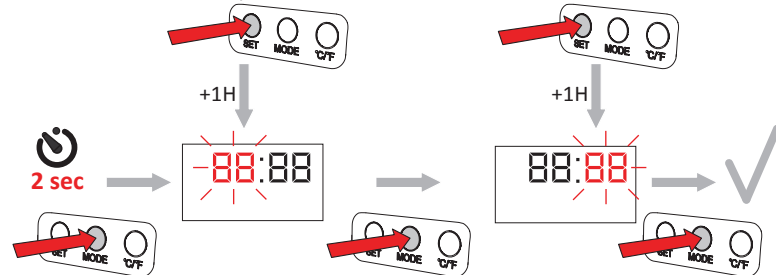

12

Activating the alarm

Alarm activeren
 Alarm aktivieren
 Activer l'alarme
 Activación de la alarma
 Alarm aktiveres
 Herätyksen aktivointi

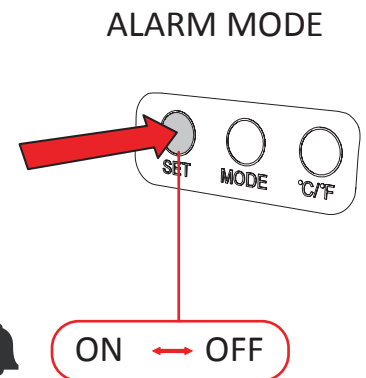

Specifications

Power supply:
 Radio Batteries: 2 x AA
 Timer Batteries: 2 x AG 13
 (Batteries not included)
 Speaker: 250mW / 8Ω

LCD Display
 Timer
 Alarm clock
 Temperature indication
 AM/FM-tuner
 AUX jack: 3.5 mm
 Water resistant

Dimensions:
 119x130x67 mm

Specificaties

Stroomvoeding:
 Batterij (radio): 2 x AA
 Batterij (timer): 2 x AG 13
 (Batterijen niet bijgeleverd)
 Luidspreker: 250mW / 8Ω

LCD display
 Timer
 Alarmklok
 Temperatuur indicatie
 AM/FM-tuner
 AUX aansluiting: 3.5 mm
 Waterbestendig

Afmetingen:
 119x130x67 mm

Technische Daten

Stromzufuhr:
 Batterie (Radio): 2 x AA
 Batterie (Timer): 2 x AG 13
 (Die Batterien sind im
 Lieferumfang nicht
 enthalten)
 Lautsprecher: 250mW / 8Ω

LCD-Display
 Timer
 Wecker
 Temperaturanzeige
 AM/FM-Tuner
 Buchse AUX: 3,5 mm
 Wasserdicht

Abmessungen:
 119x130x67 mm

Spécifications

Alimentation électrique:
 Batterie (radio): 2 x AA
 Batterie (timer): 2 x AG 13
 (Les piles ne sont pas
 livrées)
 Haut-parleur: 250mW / 8Ω

Affichage LCD
 Timer
 Horloge alarme
 Affichage de la température
 AM/FM-tuner
 Prise AUX: 3,5 mm
 Résistant à l'eau

Dimensions:
 119x130x67 mm

Especificaciones

Fuente de alimentación:
 Batería (radio): 2 x AA
 Batería (temporizador): 2 x
 AG 13
 (Las pilas no están incluidas)
 Altavoz: 250mW / 8Ω

Pantalla LCD
 Temporizador
 Reloj alarma
 Indicador de temperatura
 Sintonizador AM/FM
 Toma AUX: 3,5 mm
 Resistente al agua

Dimensiones:
 119x130x67 mm

Specifikationer

Strømforsyning:
 Batteriet (radio): 2 x AA
 Batteriet (timer): 2 x AG 13
 (Batterier er ikke inkluderet)
 Højttaler: 250mW / 8Ω

LCD-display
 Timer
 Alarmur
 Temperaturindikation
 AM/FM-tuner
 AUX stik: 3,5 mm
 Vandtæt

Dimensioner:
 119x130x67 mm

Tekniset tiedot

Syöttövirta:
 Paristo (radio): 2 x AA
 Paristo (ajastin): 2 x AG 13
 (Paristoja ei ole mukana)
 Kaiutin: 250mW / 8Ω

Nestekidenäyttö
 Ajastin
 Herätyskello
 Lämpötilänäyttö
 AM/FM-viritin
 AUX-liitin: 3,5 mm
 Vedenpitävä

Mitat:
 119x130x67 mm