

APD707 Manual



Index

- 1. Intended use
- 2. Safety
 - 2.1. Labels in this manual
 - 2.2. General safety instructions
- 3. Preparations for use
 - 3.1. Unpacking
 - 3.2. Package contents
- 4. Installation
 - 4.1. Connections
 - 4.2. Connecting to the mains
 - 4.3. Positioning the system
 - 4.4. Change the battery
- 5. Functions
 - 5.1. Remote control
 - 5.2. APD707 Portable DVD
- 6. Operation
 - 6.1. Turning the device on and off.
 - 6.2. General setup menu operation
 - 6.3. DVD/CD functions
 - 6.4. USB functions
- 7. Cleaning and maintenance
 - 7.1. Handle and care of a disc
- 8. Technical data
- 9. Disposal of used electrical and electronic equipment

1.Intended use

The appliance functions as a portable media player. The screen of the appliance can be folded up and down as well as rotated. This appliance lets you open music files (MP3/WMA), video files (MPEG-4) and photo files (JPEG). These files can be accessed via DVD, CD and USB. The appliance contains a built-in rechargeable battery.

Read the manual carefully before the first use.

2.Safety

2.1. Labels in this manual



WARNING A warning means that injury or death is possible if the instructions are not obeyed.



CAUTION A caution means that damage to the equipment is possible.



A note gives additional information, e.g. for a procedure.

2.2. General safety instructions



This appliance employs a laser system. To prevent direct exposure to the laser beam, do not open the appliance. Visible laser radiation when open and interlock defeated.



WARNING Do not put force on the appliance. The appliance can fall and can cause serious injury.



CAUTION Do not block the ventilation holes.



CAUTION Do not expose the appliance to direct sunlight.



CAUTION Do not spill any liquid on the appliance.

3.Preparations for use

3.1. Unpacking

- Unpack the appliance carefully.
- Check the package contents as described below. If any item is missing, please contact your reseller.



We recommend that you retain the original carton and packing materials in case it ever becomes necessary to return your product for service. This is the only way to safely protect the product against damage in transit. If you do dispose of the carton and the packing materials, please remember to recycle with due care to the environment.

3.2. Package contents

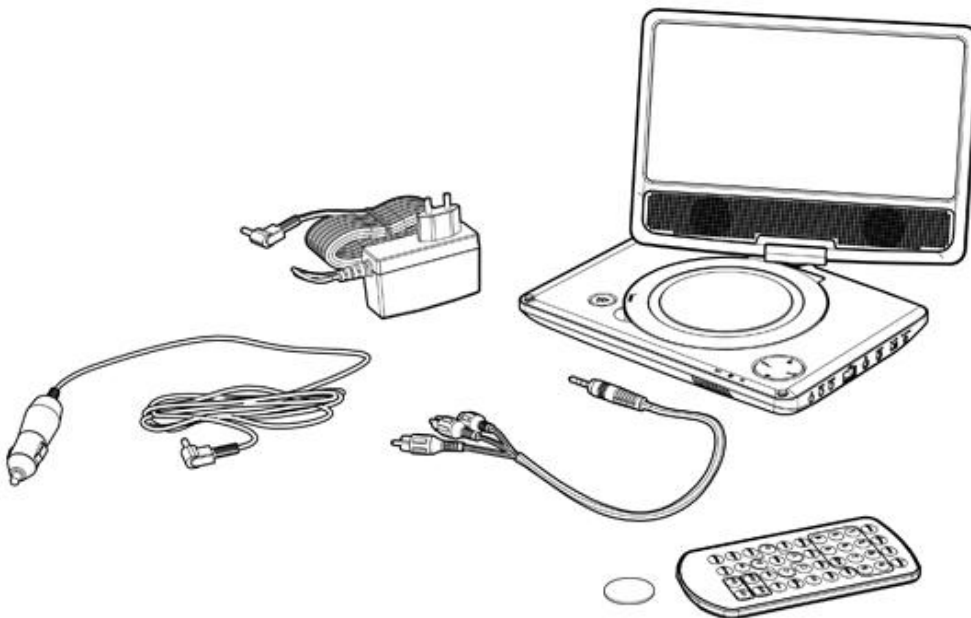

The following items are included in the received package:

- 1 x APD707 Portable DVD
- 1 x Remote control
- 1 x Button cell
- 1 x Quick start guide
- 1 x 12V Car adapter
- 1 x A/V cable



NOTE: the button cell battery has already been inserted in your remote control



If any item is missing, please contact your reseller.

4. Installation

4.1. Connections

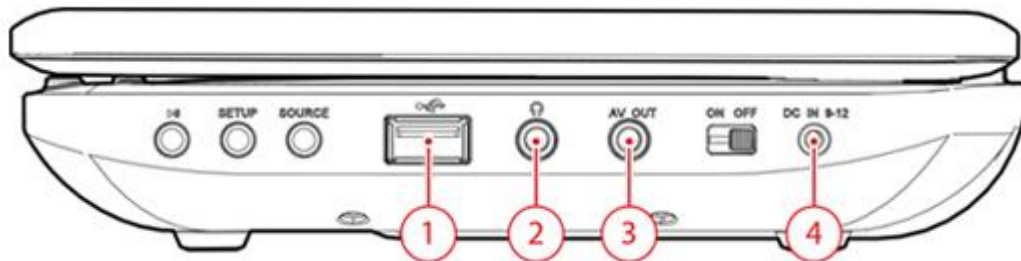

1. USB 2.0 slot
2. Headphone jack
3. AV OUT input
4. DC IN input

4.2. Connecting to the mains

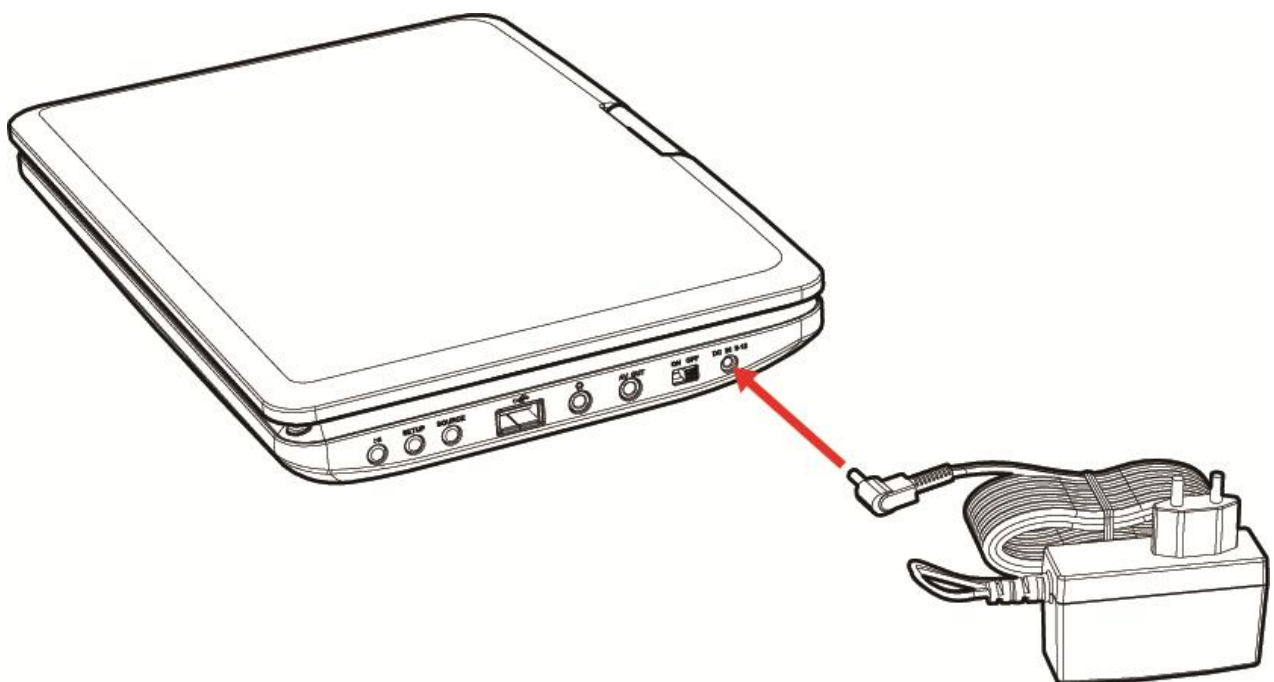

- Connect the female plug of the AC adapter to the DC IN jack
- Connect the mains plug to a wall socket.

4.3. Positioning the system

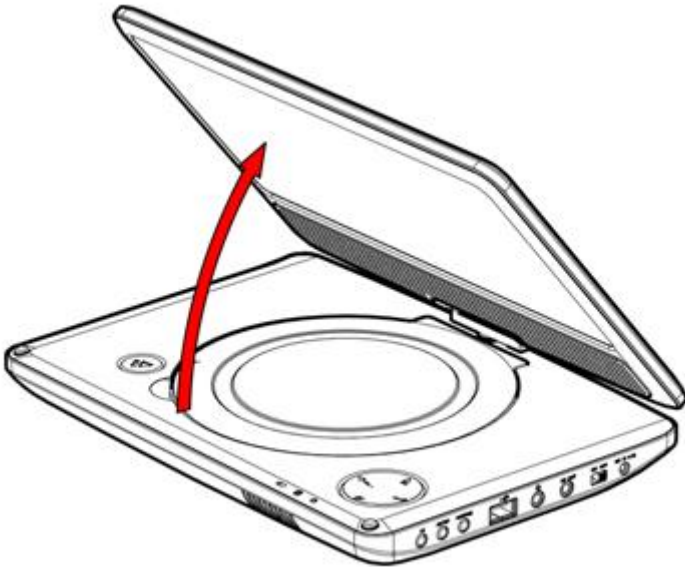

Open the display

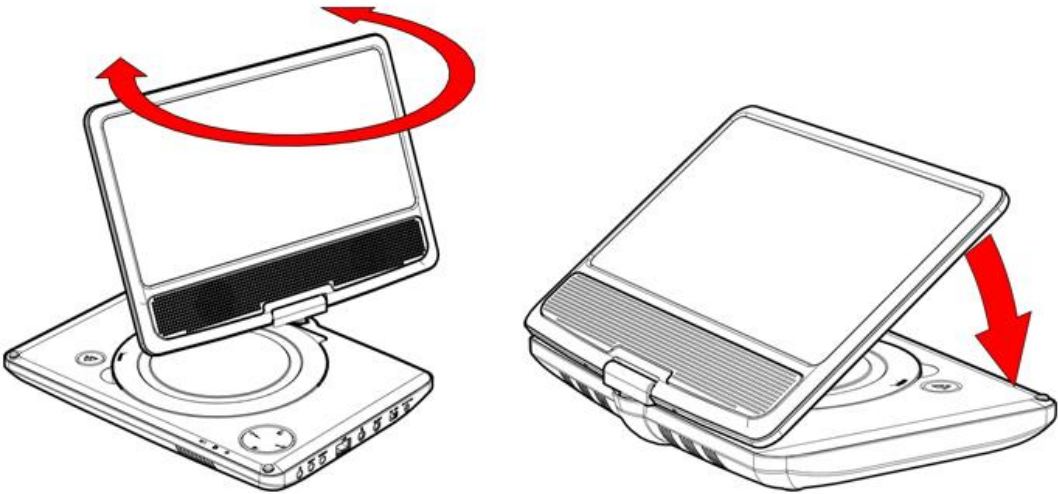

Rotating the screen

4.4. Change the battery

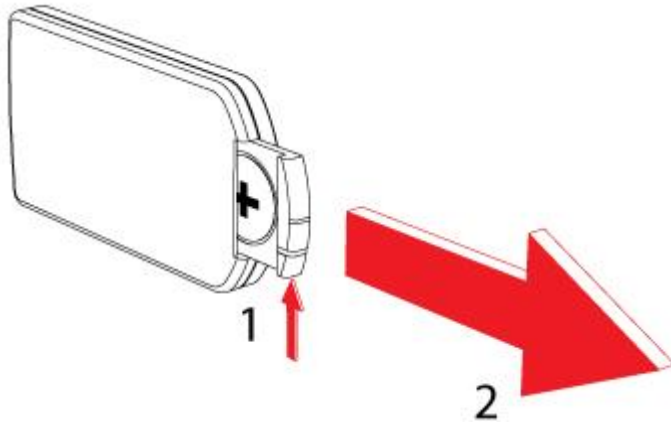

Remote control

- Pull out the battery holder
- Insert 1 lithium battery, type CR2025 3V battery
- When inserting the battery observe the (+) and (-) polarity markings.
- Insert the battery tray into the remote control.

5.Functions

5.1. Remote control

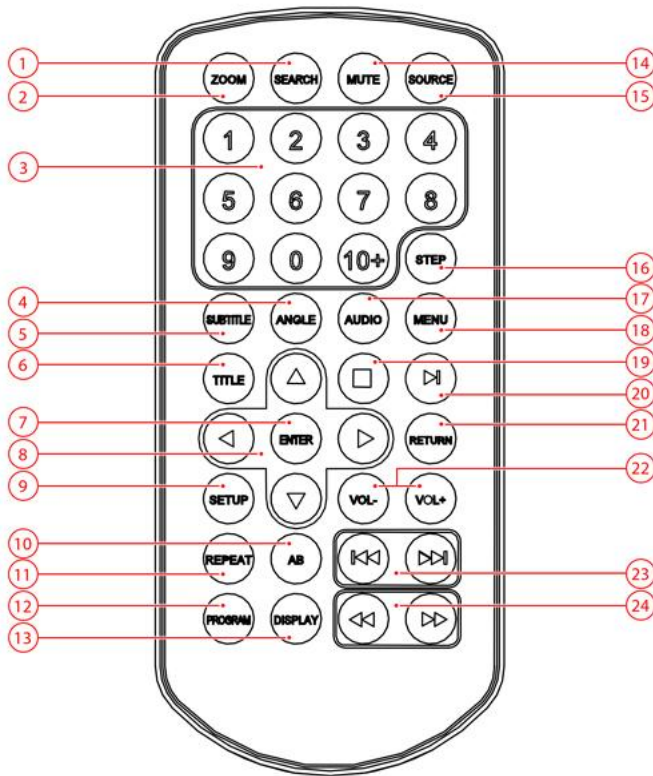

1. SEARCH button
2. ZOOM button
3. Digit buttons
4. ANGLE button
5. SUBTITLE button
6. TITLE button
7. ENTER button
8. Arrow buttons
9. SETUP button
10. AB button
11. REPEAT button
12. PROGRAM button
13. DISPLAY button
14. MUTE button
15. SOURCE button
16. STEP button
17. AUDIO button
18. MENU button
19. STOP button
20. PLAY/PAUSE button
21. RETURN button
22. VOLUME +/- button
23. REVERSE SKIP/FORWARD SKIP button
24. FAST FORWARD/FAST BACKWARD button

5.2. APD707 Portable DVD

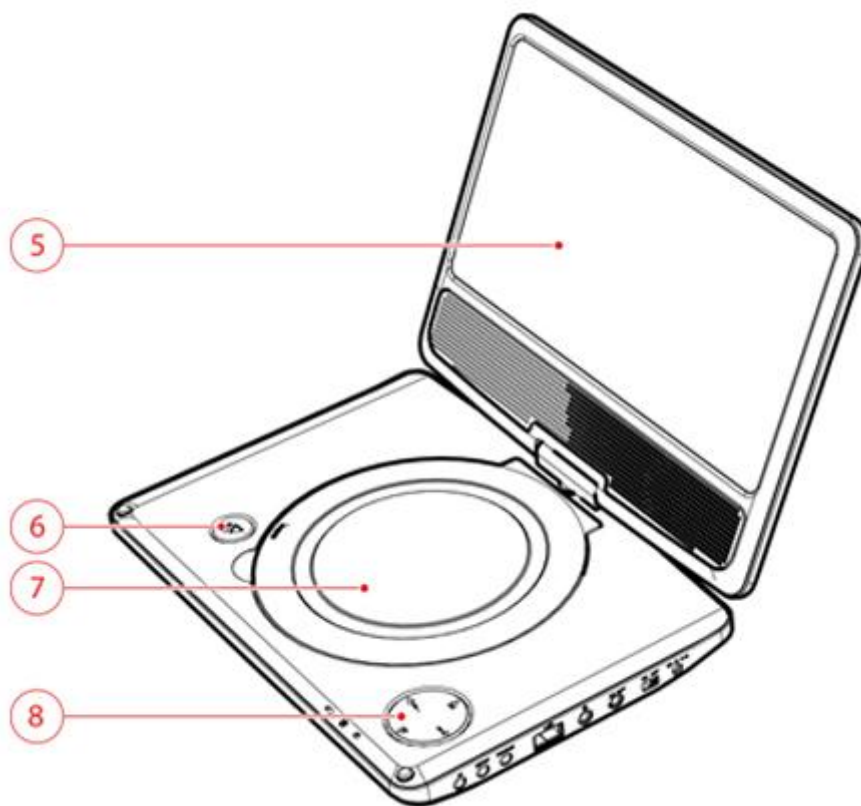
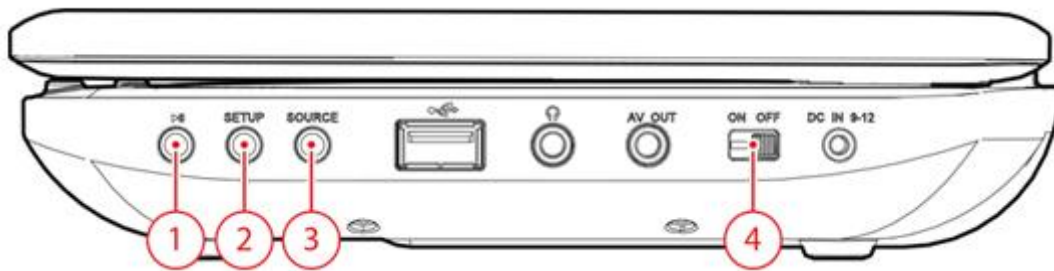

1. PLAY/PAUSE, RETURN button
2. SETUP button
3. SOURCE button
4. On / Off key (POWER)
5. Screen
6. PLAY/PAUSE button
7. DVD compartment
8. Navigation button

6.Operation

6.1. Turning the device on and off.

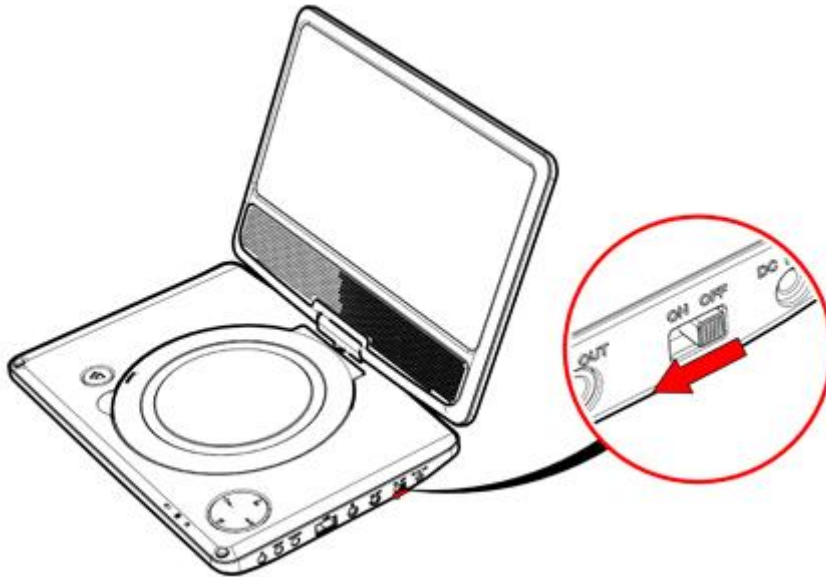

- Set the switch in the ON position to turn the equipment on.
- Set the switch in the OFF position to switch off the device.

6.2. General setup menu operation

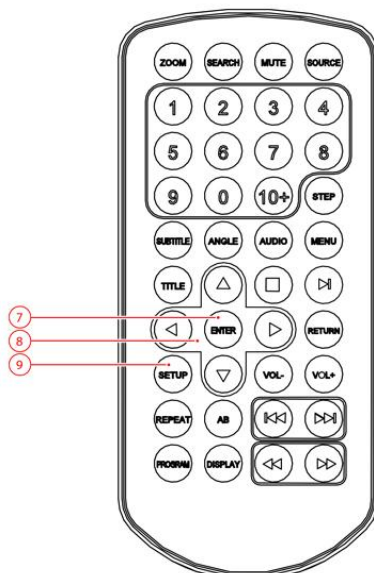

This chapter explains a complete setup of the appliance: settings of screen display, audio setup and video setup.

The following actions have to be carried out with the remote control.

- Press the SETUP button (9).
- Press the arrow buttons (left and right) (8) to select a menu. The submenu is displayed directly.
- Press the arrow buttons (up and down) (8) to scroll through the submenu.
- Press the ENTER button (7) to select a setting, or the left arrow button to cancel the selection.
- Press the SETUP (9) button to store the settings and exit.

SYSTEM SETUP

The options TV SYSTEM and TV TYPE are only applicable if the APD 707 is connected to an external screen

TV SYSTEM

- Select the video output format to match the appliance to the TV system: PAL, AUTO or NTSC.



Please note: if the wrong option has been selected, this may result in very poor image quality. In that case, select a different setting.

POWER RESUME

- When restarting the player, select ON for the DVD to resume from the last place it was stopped.

TV TYPE

- In the TV TYPE section, press the arrow buttons (8) to select 4:3 4:3 PANSCAN or 4:3 LETTERBOX for a conventional TV set. Select 16:9 for a wide screen TV set.

PASSWORD

Change the default password. Enter the current password in the first box. Enter the new password in the second box. Enter the new password again in the third box to confirm.



The default password (0000) is always active. Even if the password has been reset.

RATING

Set a rating for movies played by the appliance. Movies rated higher than the level set for the parental lock can not be viewed.

DEFAULT

Restore the default settings of the appliance.

LANGUAGE SETUP

- In the OSD LANG section, press the arrow buttons to choose the language.
- In the AUDIO LANG section, choose the audio language.
- In the SUBTITLE LANG section, choose the subtitle language.
- Select the menu language in part MENU LANG.

STANDY SETTING

- Set **STANDY SETTING** after how many hours of inactivity your APD707 is automatically placed on standby mode
- Choose from 3 hours, 4 hours or never (OFF)

VIDEO SETUP

BRIGHTNESS: Adjust the screen brightness.

CONTRAST: Adjust the contrast of the image.

HUE: Adjust the colour intensity.

SATURATION: Adjust the saturation of the image.

SHARPNESS: Adjust the screen sharpness.

6.3. DVD/CD functions

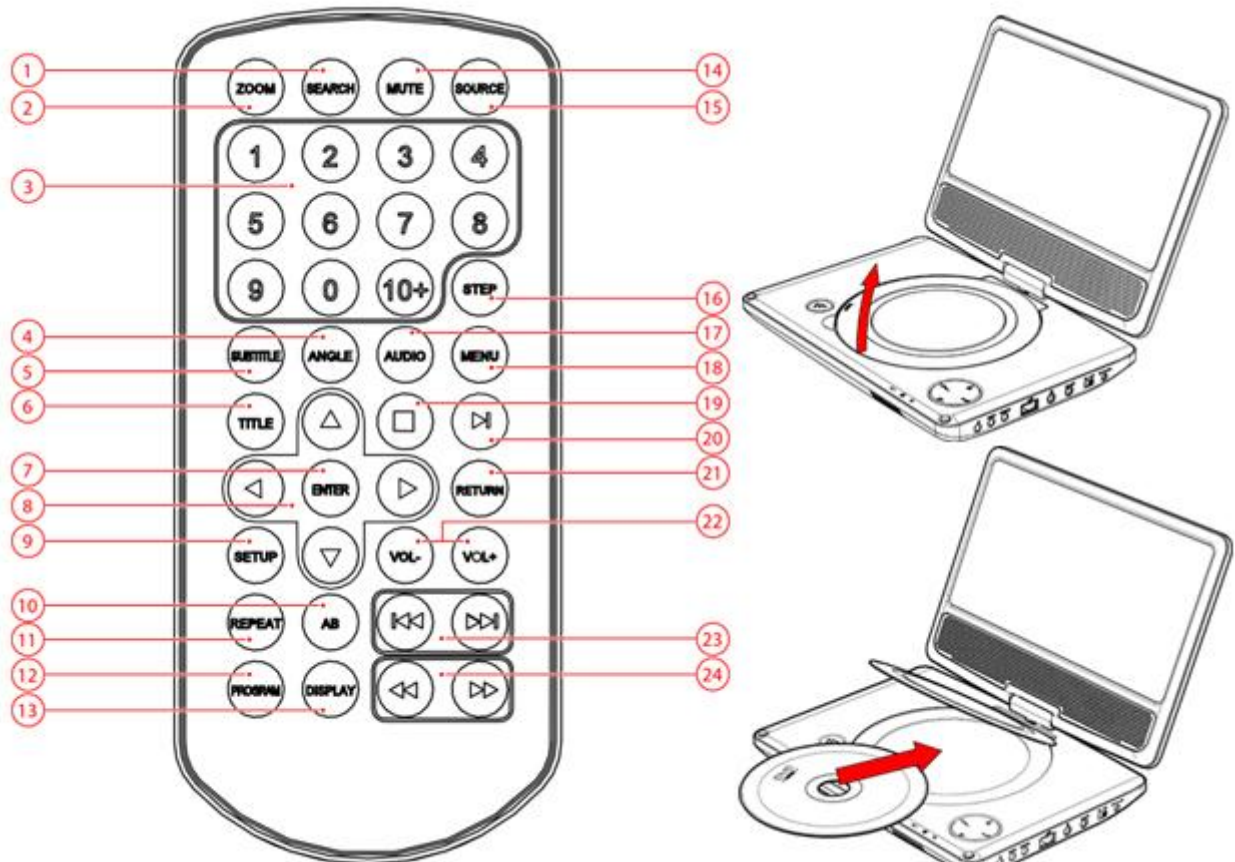

Control

- After the disc has been loaded, a content menu will display on the screen.
- Press the arrow buttons (8) to select a menu item.
- Press the ENTER button (7) to enter the selected menu item.
- Press the RETURN button (21) to return to the upper page.

During playback, the following functions are available:

- To select a chapter (DVD) or track (CD), press the digit buttons (3).
- In order to select a track 10 or greater, first press the 10+ button. For example; select track 12, first press 10+, and then press number 2 button.
- To pause playback, press the PLAY/PAUSE button (20) once; to resume playback, press the button again.
- To stop playback temporarily, press the STOP button (19) once. Press the button again to stop playback permanently, or press the PLAY/PAUSE button (20) to resume playback.
- To select the next or previous chapter (DVD) or track (CD), press the PREV button (23) or the NEXT button (23).
- To forward or rewind the DVD, press the FWD button (24) or the REV button (24). The available speed rates are: 2x, 4x, 8x, 20x.
- To adjust the volume, press the VOL + button or the VOL - button (22).

- To mute or restore sound, press the MUTE button (14).
- SUBTITLE (5): select the subtitles for the VIDEO file that is playing (if available)
- DVD: To select the audio language of a DVD, press the AUDIO button (17) repeatedly until the desired language is set.
- CD VCD: Select the desired sound with this view (STEREO, LEFT, RIGHT)
- To select the camera angle, press the ANGLE button (4).
- To play the DVD frame by frame, press the STEP button (16). Press the PLAY/PAUSE button (20) to resume normal playback.

To repeat a chapter (DVD) or one or all tracks (CD):

- Press the REPEAT button (11) once to repeat the current chapter or track.
- Press the button twice to repeat all chapters or tracks.

The AB (10) function can be used to repeat a specific section of a DVD.

- Press the AB (10) once to select the starting point (A).
- Press the AB (10) button again to select the ending point (B). The appliance plays the section repeatedly.

Navigation

- Press the MENU button (18) to return to the content menu during playback.
- To view a specific title of a DVD, press the TITLE button (6). Use the arrow buttons to select the title.
- Use the SEARCH button (1) to go to a time point, title or chapter of choice in DVD Mode.
- Use the SOURCE button (15) to switch between DVD or USB input.

Using the PROGRAM function

With the PROGRAM (12) function favourite tracks from the disks can be stored.

- Press the PROGRAM button (12) to enter the PROGRAM function.
- Press the digit buttons (8) to select a desired track, and use the arrow button down to highlight the next entry.
- Press the PROGRAM (12) button and select CLEAR in the menu to resume playback.
- To view JPEG images you can press the PROGRAM button (12) repeatedly to go to slide show mode.

Using the ZOOM function

This function can be used for zooming in and out on photos and DVDs. The available zoom ratios are: 2x, 3x, 4x, 1/2, 1/3, 1/4.

- Press the ZOOM button (1).
- Press the ZOOM (1) button again to set the correct size.
- Press the arrow buttons (8) to move through the picture.



Please note:



DVDs and DVD appliances are manufactured under the worldwide agreed DVD regional code system that the appliance will operate only with corresponding disc of the same regional code. If the code number on the label of a DVD does not match that on the label alongside, the DVD will not play on this appliance.

If a disc contains mixed content (e.g. MP3 and video files), the appliance will only recognise, list and play one content type.

Normally, if an MP3 disc is loaded, the unit will take longer time to read the initial data.

6.4. USB functions

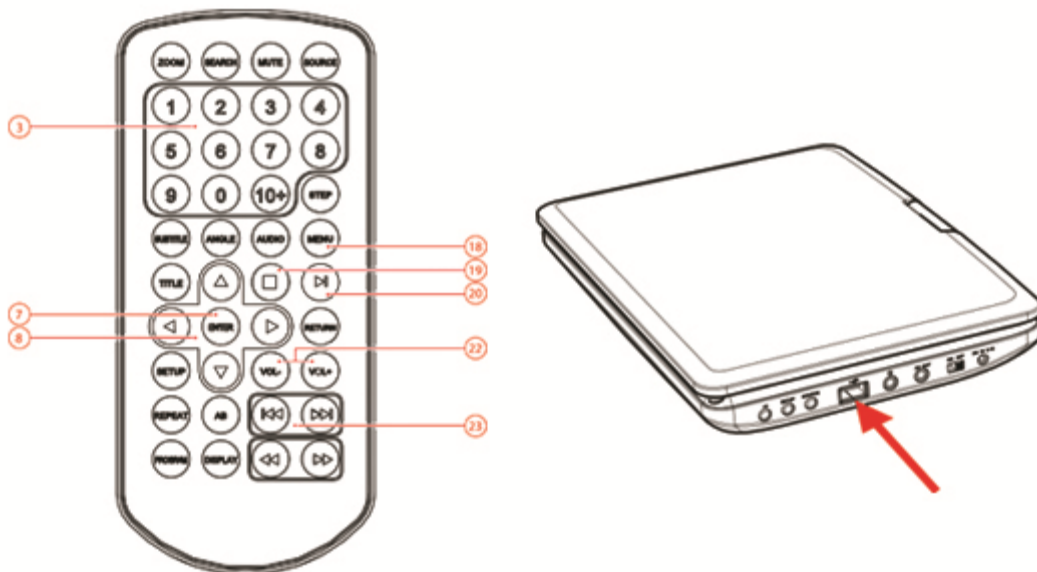

Insert the USB device in the slot . The device can only be connected one way.

After the device has been connected, a content menu will display on the screen.

- Press the arrow button (8) (up and down) to select a folder or a file.
- Press the ENTER button (7) to enter the selected folder or file. You can also use the digit buttons (3) to select a folder or to play the file.
- Press the MENU button (18) to return to the content menu during playback.

During playback, the following functions are available:

- To select a track, press the PREV button (23) or the NEXT button (8) until the desired track is set.
- To pause playback, press the PLAY/PAUSE button (20) once; to resume playback, press the button again.
- To stop playback, press the STOP button (19).
- To adjust the volume, press the VOL + button or the VOL - button (22).
- To remove the device, gently pull it out of the slot.



Due to the great variety of products with USB ports and their sometimes quite manufacturer-specific functions we can neither guarantee that all devices will be recognised, nor that all operating options that are possible in theory will actually work.

7.Cleaning and maintenance



WARNING Before performing any cleaning or maintenance, switch off and unplug the appliance.

Clean the outside of the appliance with a soft cloth. When the appliance is very dirty, dampen the cloth slightly with water and a neutral solution.

7.1. Handle and care of a disc

- Hold the disc with fingers. Hold the disc outer edge and/or the centre spindle hole. Do not touch the disc surface.
- Do not bend or press the disc. Do not expose the disc to direct sunlight or heating sources.
- Clean the disc surface with a soft, dry cleaning cloth. Wipe the disc surface gently, radially, from centre towards the outer edge.
- Do not apply thinner, alcohol, chemical solvent, or sprays when cleaning. Such cleaning fluids will permanently damage the disc surface.

8. Technical data

APD707 Portable DVD

Voltage: 100 - 240VAC / 50/60 Hz

Power consumption: 10W

Frequency response: 20Hz ~20KHz (1dB)

Speaker output: 2 x 1 Watt

Appliance features

16:9 aspect ratio with 17.8 cm screen (7")

USB 2.0 slot

Headphone jack

Accessories

12V Car adapter

CINCH cable

Quick start guide

Disc output

Television system: PAL/NTSC

Frequency range: 20Hz ~20KHz

Signal/noise ratio: >80dB (ANALOG OUT connectors only)

Dynamic range: >85dB (DVD/CD)

Remote control

Battery size: CR2025 (penlite)

Supported media formats

Disc types: DVD/DVD+R(W)/DVD-R(W)/(S)VCD

Picture formats: JPEG

Video formats: MPEG4

Audio formats: MP3 / WMA

Working environment

Operating temperature: - 10 ~ +35 C(elsius)

Relative humidity: 5% ~90%

9. Disposal of used electrical and electronic equipment



The meaning of the symbol on the material, its accessory or packaging indicates that this product shall not be treated as household waste. Please, dispose of this equipment at your applicable collection point for the recycling of electrical and electronic equipments waste. In the European Union and Other European countries which there are separate collection systems for used electrical and electronic product. By ensuring the correct disposal of this product, you will help prevent potentially hazardous to the environment and to human health, which could otherwise be caused by unsuitable waste handling of this product. The recycling of materials will help conserve natural resources. Please do not therefore dispose of your old electrical and electronic equipment with your household waste.

For more detailed information about recycling of this product, please contact your local city office, your household waste disposal service or the shop where you purchased the product.

For more information and warranty conditions, please visit: www.akai.eu



Do not dispose of batteries as household waste but take them to a battery recycling facility.