

AMD320 manual



Index

- 1. Intended use
- 2. Safety
 - 2.1. Labels in this manual
 - 2.2. General safety instructions
- 3. Preparations for use
 - 3.1. Unpacking
 - 3.2. Package contents
- 4. Installation
 - 4.1. Install batteries
 - 4.2. Connecting the system
 - 4.3. Connecting random equipment
 - 4.4. Connecting to the mains
- 5. Functions
 - 5.1. Remote control
 - 5.2. AMD320 Microset
- 6. Operation
 - 6.1. Quick start
 - 6.2. General setup menu operation
 - 6.3. DVD/CD functions
 - 6.4. Radio functions
 - 6.5. USB functions
 - 6.6. LINE-IN
 - 6.7. Operation with BLUETOOTH
- 7. Cleaning and maintenance
 - 7.1. Handle and care of a disc
- 8. Technical data
- 9. Disposal of used electrical and electronic equipment

1.Intended use

The Microset plays music from CDs, and music, videos and photos from DVDs and USB. The appliance shows photos from Kodak picture CDs as well. The appliance also offers the option to rip CDs. The Microset can be operated via Bluetooth. Read the manual with care before using it for the first time.

The DVD Microset plays music from CDs and music, videos and photos from DVDs and USB. The Microset can be controlled by bluetooth. Read the manual carefully before the first use.



DVDs and DVD appliances are manufactured under the worldwide agreed DVD regional code system that the appliance will operate only with corresponding disc of the same regional code. If the code number on the label of a DVD does not match that on the label alongside, the DVD will not play on this appliance.



The appliance has built in copyright protection technology that prevents copying from a disc to any media. If a video recorder is connected to the appliance, the video output image will be distorted during recording.



Manufactured under license from Dolby Laboratories. "Dolby" and the double-D symbol are trademarks of Dolby Laboratories. Confidential unpublished works. Copyright 1992-1997 Dolby Laboratories. All rights reserved.



Because of the great variety of products with USB ports and their sometimes quite manufacturer-specific functions we can neither guarantee that all devices will be recognised, nor that all operating options that are possible in theory will actually work.

2.Safety

2.1. Labels in this manual



WARNING A warning means that injury or death is possible if the instructions are not obeyed.



CAUTION A caution means that damage to the equipment is possible.



A note gives additional information, e.g. for a procedure.

2.2. General safety instructions



WARNING Do not put force on the appliance. The appliance can fall and can cause serious injury.



CAUTION Do not spill any liquid on the appliance.



WARNING Do not insert any objects in the ventilation holes.



CAUTION Do not block the ventilation holes.



This appliance is double insulated; therefore no earth wire is required. Always check that the mains voltage corresponds to the voltage on the rating plate.



This appliance employs a laser system. To prevent direct exposure to the laser beam, do not open the appliance. Visible laser radiation when open and interlock defeated.

3.Preparations for use

3.1. Unpacking

- Unpack the appliance carefully.
- Check the package contents as described below. If any item is missing, please contact your reseller.
- Remove the labels from the front panel carefully if present.



We recommend that you retain the original carton and packing materials in case it ever becomes necessary to return your product for service. This is the only way to safely protect the product against damage in transit. If you do dispose of the carton and the packing materials, please remember to recycle with due care to the environment.

3.2. Package contents

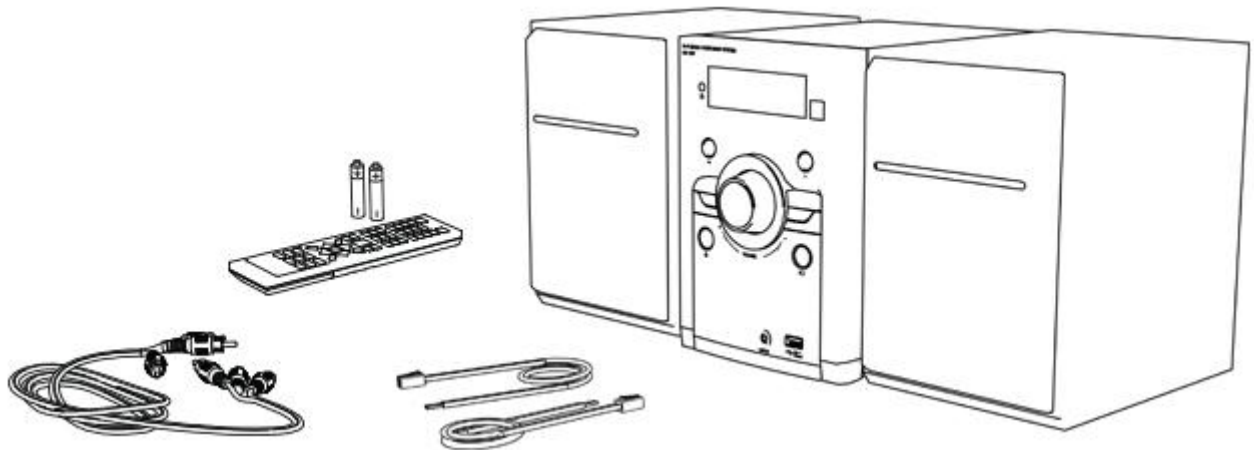

The following items are included in the received package:

- 1 x AMD320 DVD Micro System
- 2 x Speaker
- 1 x Remote control
- 2 x Batteries (AAA)
- 1 x A/V cable
- 2 x speaker wire



If any item is missing, please contact your reseller.

4. Installation

4.1. Install batteries

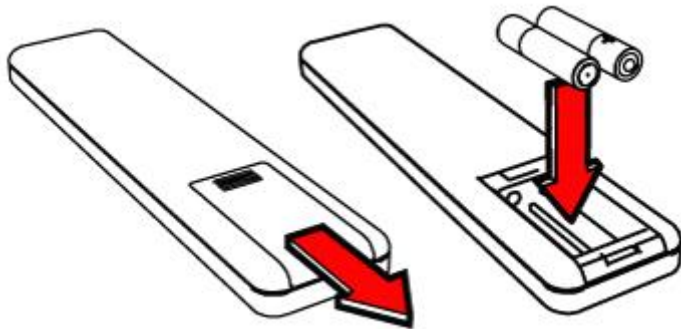

Install batteries

- Remove the battery cover.
- Insert the batteries matching the (+) and (-) polarity markings.



CAUTION Incorrect installation can cause battery leakage and corrosion which will damage the appliance. Corrosion, oxidation, battery leakage and any other gradually acidic defect of this nature will invalidate the guarantee.

4.2. Connecting the system

Connect the speakers to the appliance.

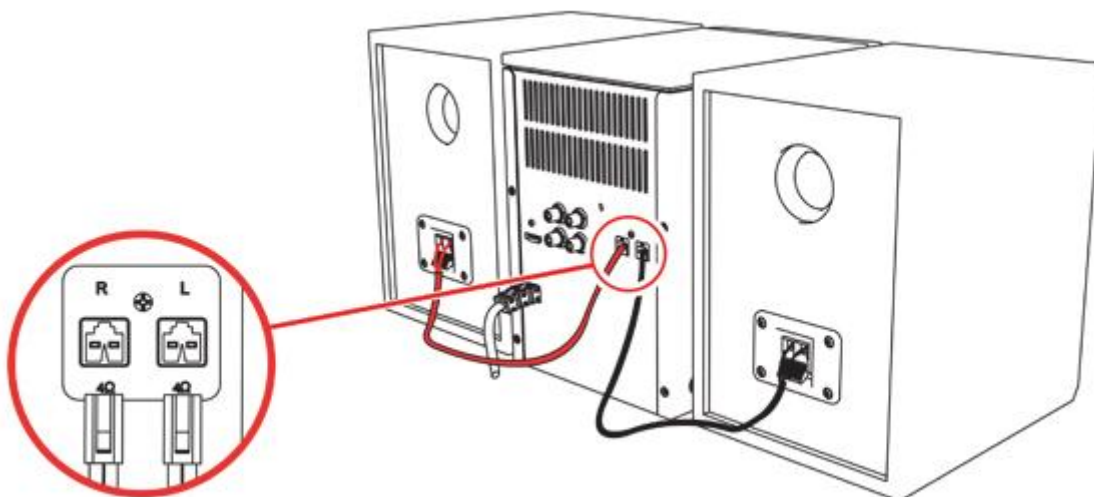

4.3. Connecting random equipment

Connect the tv

- Use one of the cables as presented in the image below.

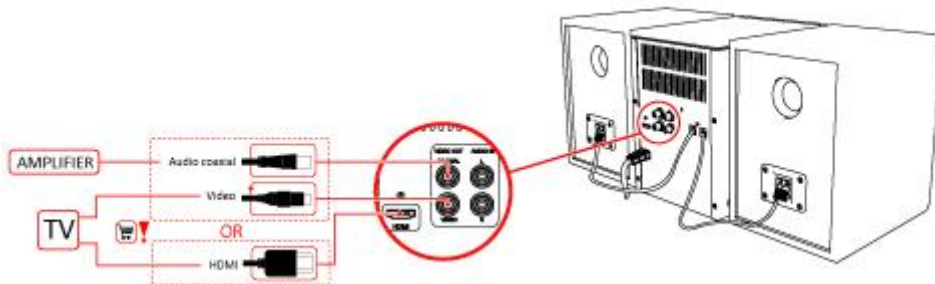

4.4. Connecting to the mains

Connect the appliance to the mains.

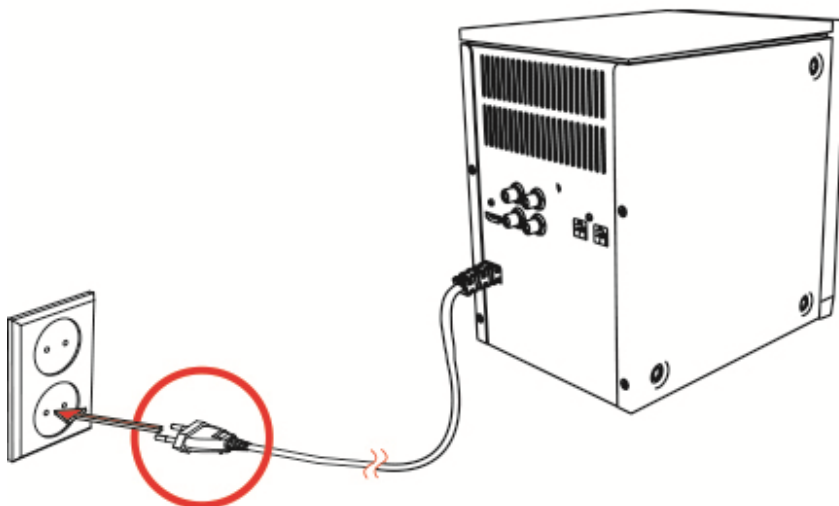

Switch on the appliance.

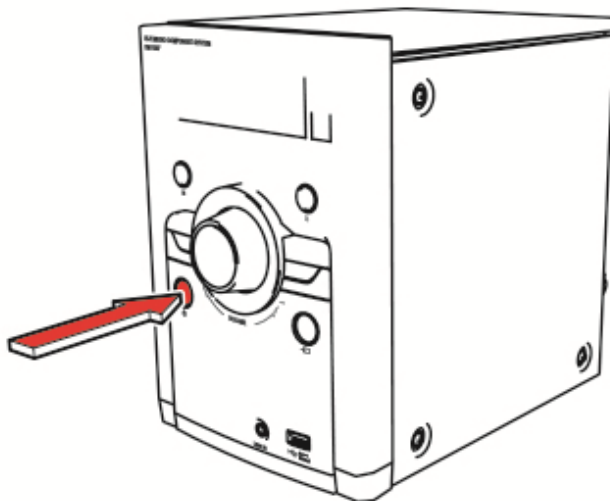

5.Functions

5.1. Remote control

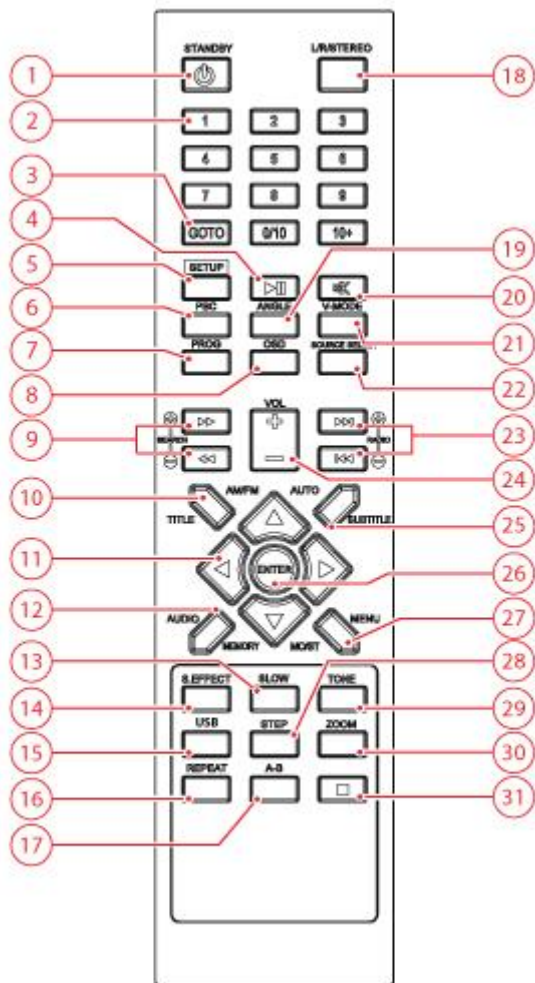

1. STANDBY button
2. Digit buttons
3. GOTO button
4. PLAY / PAUSE button
5. SETUP button
6. PBC button
7. PROGRAM button
8. OSD button
9. FAST FORWARD / REWIND button
10. TITLE button
11. Arrow buttons
12. AUDIO button
13. SLOW button
14. SOUND EFFECT button
15. USB button
16. REPEAT button
17. A-B REPEAT button
18. L/R/STEREO button
19. ANGLE button
20. MUTE button

21. V-MODE button
22. SOURCE SELECT button
23. NEXT / PREVIOUS button
24. VOLUME button (+/-)
25. SUBTITLE button
26. ENTER button
27. MENU button
28. STEP button
29. RESET button
30. ZOOM button
31. STOP button

5.2. AMD320 Microset

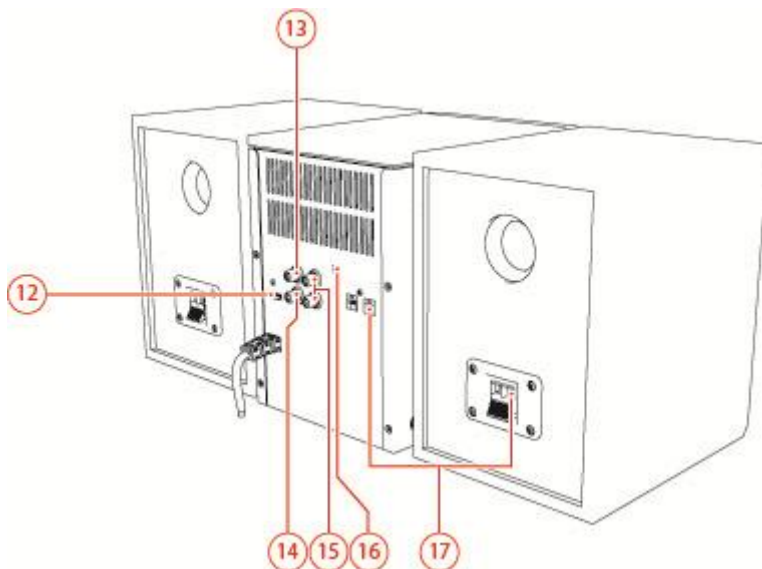
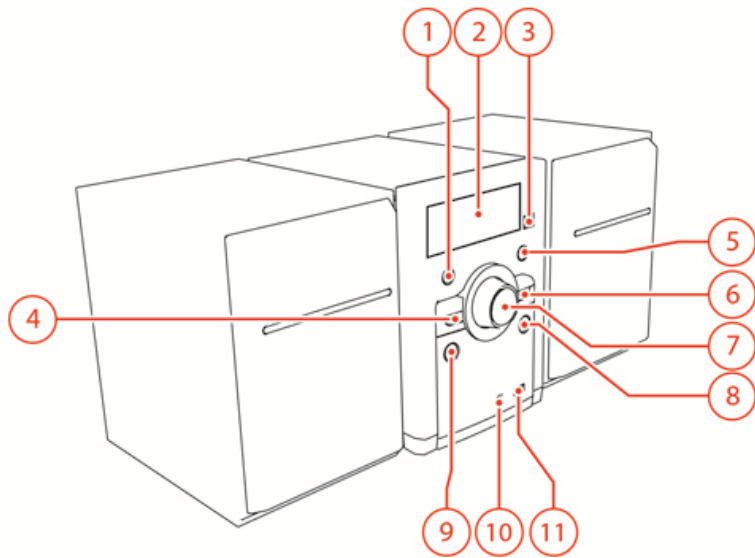

1. PLAY/ PAUSE
2. DISPLAY SCREEN
3. REMOTE CONTROL SENSOR
4. PREVIOUS
5. STOP
6. NEXT
7. VOLUME +/-
8. SOURCE
9. STANDBY
10. AUX IN
11. USB 2.0 slot
12. HDMI
13. COAXIAL DIGITAL AUDIO OUTPUT
14. COMPOSITE VIDEO OUTPUT
15. LEFT / RIGHT AUDIO INPUT
16. FM wire antenna
17. Connection to speakers

6.Operation

All functions of the appliance are accessible using the remote control. All instructions refer to operation with the remote control, unless indicated otherwise.

6.1. Quick start

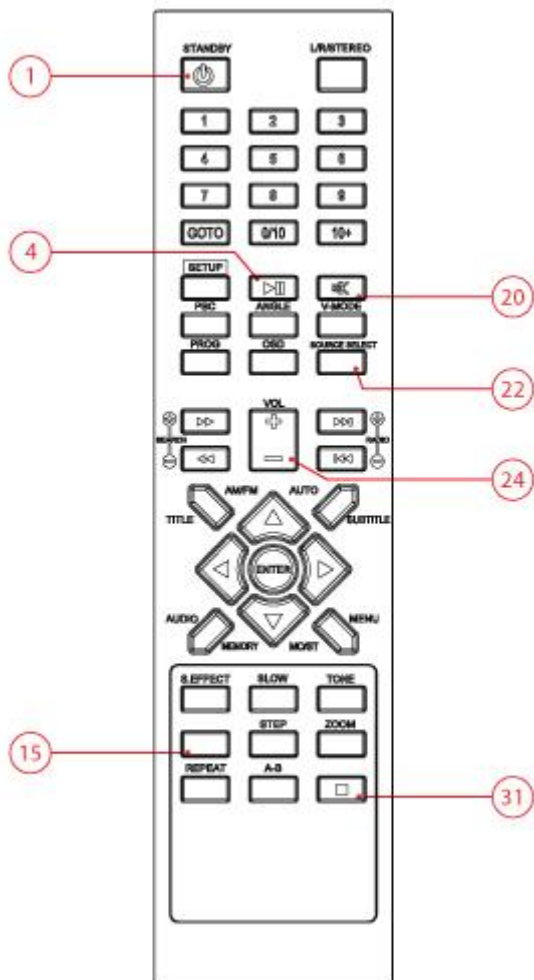

General functions

- Set the appliance in the standby mode.
- To switch on the appliance, press the STANDBY button (1). To switch back to the standby mode, press the STANDBY button (1) again.
- To adjust the volume, press the VOL + button or the VOL - button (24).
- To mute or restore sound, press the MUTE button (20).

DVD/CD functions

- Turn on the television.
- Switch on the appliance.
- To select the source mode DVD/ CD, press the SOURCE SELECT button (22).
- Push the disc cover to load the disc and then close the cover.

The display shows the total number of tracks on the CD.

- To start playback, press the PLAY/PAUSE button (4) once.
- To stop playback, press the STOP button (31).
- For extended instructions, read the paragraph DVD/CD functions further on in this manual.

Tuner functions

- Switch on the appliance.
- To select the source mode TUNER, press the SOURCE button (22).

AUX

- To select the source mode AUX, press the SOURCE button (22).
- Connect the external appliance to your AMD320 Mircoset.

USB and Memory card functions



Please note: the disc cover must be closed in order to use the USB functions.

- Switch on the appliance.
- Insert the USB device in the slot . The device can only be connected one way.
- Press the USB button (15).
- To start playback, press the PLAY/PAUSE button (4) once.
- To stop playback, press the STOP button (31).
- For extended instructions, read the paragraph "USB and Memory card" further on in this manual.

6.2. General setup menu operation

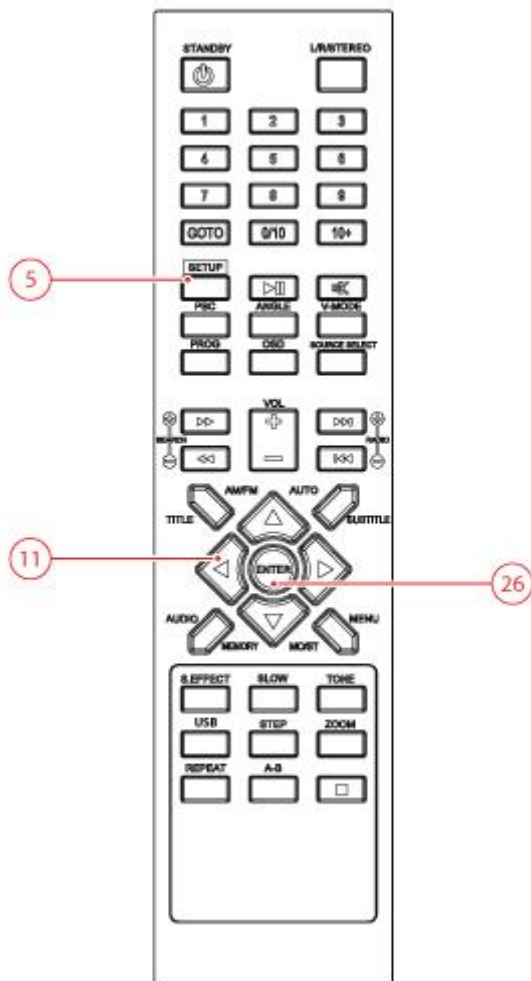

This chapter explains a complete setup of the appliance: settings of screen display, audio setup and video setup.

General settings menu

To change the initial settings

The following actions have to be carried out with the remote control.

- Press the SETUP button (5).
- Press the arrow buttons (left and right) (12) to select a menu. The submenu is displayed directly.
- Press the arrow buttons (up and down) (11) to scroll through the submenu.
- Press the ENTER button (26) to select a setting, or the left arrow button to cancel the selection.
- Press the SETUP (5) button to store the settings and exit.

Picture format

In the TV DISPLAY section, press the arrow buttons (11) to select 4:3 4:3 PANSKAN or 4:3 LETTERBOX for a conventional TV set. Select 16:9 for a wide screen TV set.

OSD LANG

- In the OSD LANG section, press the arrow buttons to choose the language.

Screensaver on/off

The screensaver will be turned on automatically when there is no picture.

Last memory: on/off

When the DVD is paused, playback will automatically resume from where last stopped.

VIDEO

Colour settings

RESOLUTION: select the desired resolution.

SHARPNESS: Adjust the screen sharpness.

BRIGHTNESS: Adjust the screen brightness.

CONTRAST: Adjust the contrast of the image.

HUE: Adjust the colour intensity.

SATURATION: Adjust the saturation of the image.

GAMMA: Adjust the colour intensity.

Preference setup page

Select the video output format to match the appliance to the TV system: PAL, AUTO or NTSC.
The video output format can only be selected when the DVD tray is empty.



Please note: if the wrong option has been selected, this may result in very poor image quality. In that case, select a different setting.

Language setup page

In the SUBTITLE section, choose the subtitle language.

In the AUDIO section, choose the audio language.

In the DISC MENU section, choose the language for the disc menu.

Rating setup page

CHILD LOCK

- Set a rating for movies played by the appliance. Movies rated higher than the level set for the parental lock can not be viewed.



This function is only available with discs that have parental rating encoded.

SET PASSWORD

Change the default password. Enter the current password in the first box. Enter the new password in the second box. Enter the new password again in the third box to confirm.



The default password (0000) is always active. Even if the password has been reset.

DEFAULT

Restore all default settings of the appliance, except the settings for the menu items PARENTAL and PASSWORD.

6.3. DVD/CD functions

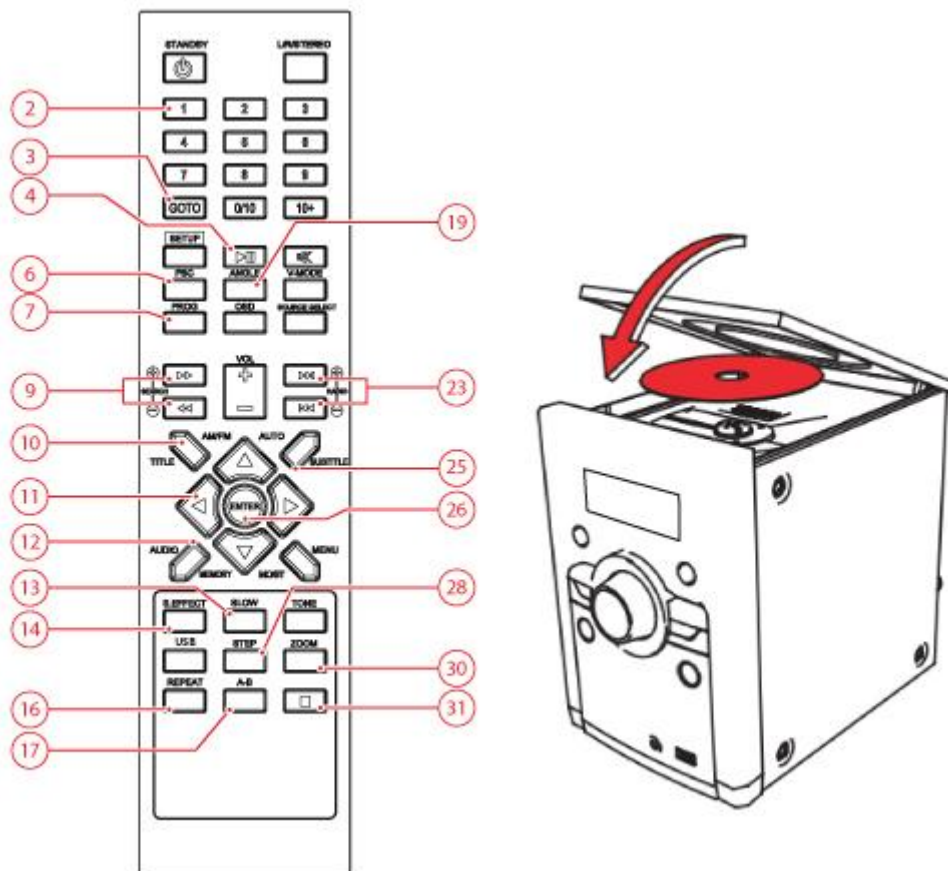

Preparation

- Turn on the television.

After the disc has been loaded, a content menu will display on the TV screen.

- Press the arrow buttons (11) to select a menu item.
- Press the ENTER button (26) to enter the selected menu item.

During playback, the following functions are available:

- To select a chapter (DVD) or track (CD), press the digit buttons (2).
- To select the next or previous chapter (DVD) or track (CD), press the PREV button (23) or the NEXT button (23).
- To forward or rewind the DVD, press the FWD button (9) or the REV button (9). The available speed rates are: 2x, 4x, 8x, 16x, 32x.
- To playback in slow-motion, either forward or backward, press the SLOW button (13) repeatedly. The available speeds are: 1/2, 1/4, 1/6, 1/8, 1/16.
- To play the DVD frame by frame, press the STEP button (28). Press the PLAY/PAUSE button (4) to resume normal playback.
- To pause playback, press the PLAY/PAUSE button (4) once; to resume playback, press the button again.
- To stop playback temporarily, press the STOP button (31) once. Press the button again to stop playback permanently, or press the PLAY/PAUSE button (4) to resume playback.
- To select extra information of a DVD or CD (remaining time/passed playtime/track number/chapter number), press the OSD button (8).

To repeat a chapter (DVD) or one or all tracks (CD):

- - Press the REPEAT button (16) once to repeat the current chapter or track.
- To view a specific title of a DVD, press the TITLE button (10). Use the arrow buttons to select the title.
- To switch on the subtitles of a DVD, press the SUBTITLE button (25). Press the button again to switch off the subtitles.
- To select the camera angle, press the ANGLE button (19).
- To select the audio language of a DVD, press the AUDIO button (12) repeatedly until the desired language is set.
- To switch between sound effects (hall/concert/cave/bathroom), press the S.EFFECT button (14).
- Press the GOTO (3) button to access the quick menu. Use numerical buttons to input track number and track time. Press ENTER to confirm a selection.
- Push the GOTO (3) button to load the quick start menu. Then select the desired time and number and push the ENTER (26) button, followed by the GOTO button.

Using the A-B REPEAT function

- The A-B REPEAT function can be used to repeat a specific section of a DVD.
- Press the A-B REPEAT button (17) once to select the starting point (A).
- Press the A-B REPEAT button again to select the ending point (B). The appliance plays the section repeatedly.
- To cancel the A-B REPEAT function, press the A-B REPEAT button again. The appliance will resume the normal playback.



Please note:

- Normally, if an MP3 disc is loaded, the unit will take longer time to read the initial data.
- A DVD that does not match the region code cannot be read by this appliance.
- If a disc contains mixed content (e.g. MP3 and video files), the appliance will only recognise, list and play one content type.

Using the PROGRAM function

For video discs and audio CDs

- Turn on the television.
- Press the PROGRAM button (7) to enter the PROGRAM function.
- Press the digit buttons (2) to select a desired track, and use the arrow button down to highlight the next entry.
- To confirm the selection and start the program, move the highlight to "START" and press the ENTER (26) button.
- Press the button PLAY/ PAUSE (4) to start program playback.

Using the MP3/MPEG4 playback function

- Insert an MP3/MPEG4 disc. A content menu will display on the TV screen.
- Press the up/down arrow buttons to select a folder or a file.
- Press ENTER (26) to enter the selected folder or file.
- Press the MENU button (28) to return to the content menu during playback.

Using the ZOOM function

This function can be used for zooming in and out on photos and DVDs. The available zoom ratios are: 2x, 3x, 4x, 1/2, 1/3, 1/4.

- Press the ZOOM button (30).
- Press the ZOOM (30) button again to set the correct size.
- Press the arrow buttons (11) to move through the picture.

Using the Kodak picture CD playback function

- Insert a Kodak picture CD.
- Press the STOP button (31) to enter the thumbnail mode. Choose an option (Slide show/Menu/prev-next) and press ENTER (26).
- Select an image using the arrow keys (11). Press ENTER (26) to view the image.
- In the overview with the small images you can also select the functions SLIDE SHOW, MENU, PREV or NEXT. Use the arrow keys (11) to select the desired functions and ENTER (26) to confirm.
- Press the PLAY/PAUSE button (4) to hold the slide show at the current picture.
- Press the PLAY/PAUSE button (4) to resume the slide show.
- Press the PREV or NEXT buttons (23) to select the previous or next picture.
- To magnify the picture, press the ZOOM button (30). To zoom in or out on the picture, press the FastForward button (9) or FastRewind button (9). To move the picture, press the arrow buttons (11).
- To flip the image vertical or horizontal, press the up/down arrow buttons .
- To rotate the image left or right, press the left/right arrow buttons .



The slide show is paused in the zoom mode. The image rotation and wipe effect functions are not available in the zoom mode.

Using the Video CD playback function

- Press the PBC button (5) to switch on the playback function.
- Insert a Video CD.
- To start playback, press the PLAY/PAUSE button (4) once.
- Press the PBC button (6) to quit the playback and return to the main menu.

6.4. Radio functions

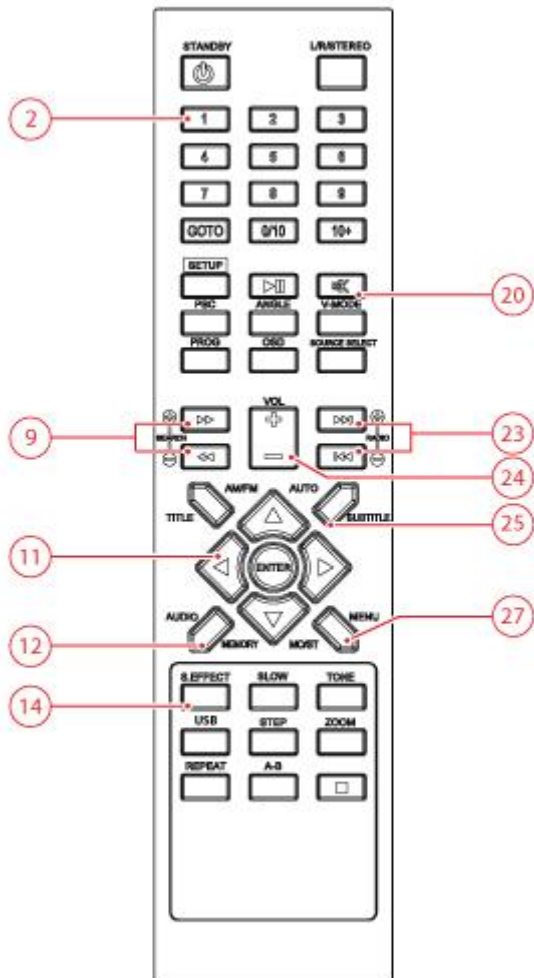

- Press the SOURCE button (22) to select the tuner mode.
- To switch between Mono and Stereo reception, press the MO/ST button (27).
- Touch MEMORY (12) to add the current station to your favourites. Use the number buttons to determine the preset position. Start with a 0 for numbers under ten.
- Quick installation of the list of stations: Press 3 seconds on the key AUTO (25) to start the search programme for automatically setting the available channels.
- To select a preset station, press the digit buttons (2).
- Search for the desired frequency with the SEARCH button (9).
- To skip to the next preset station, press the RADIO buttons (+ or -) (23).

6.5. USB functions

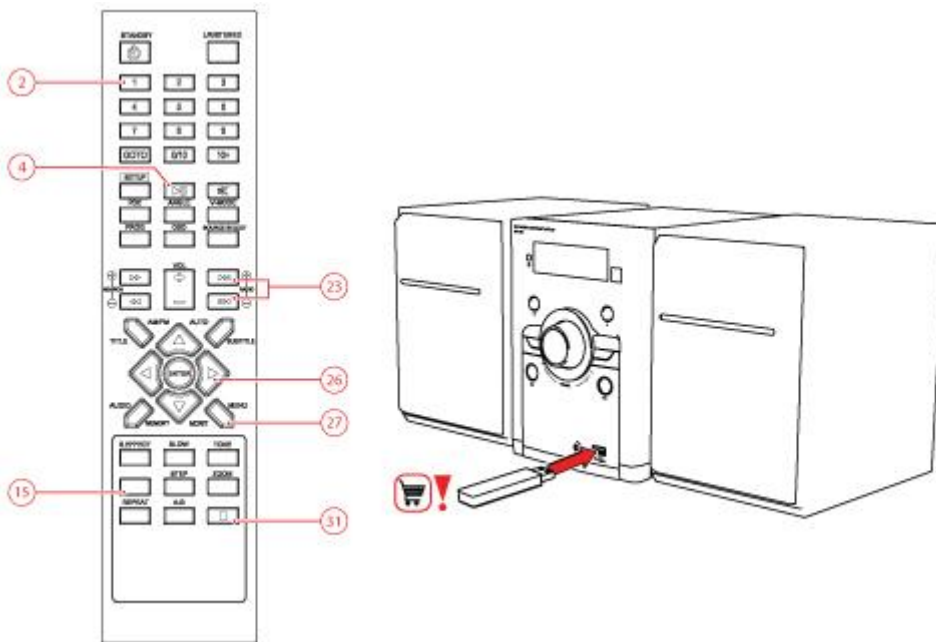

Preparation

- Turn on the television.
- Insert the USB device in the slot . The device can only be connected one way.
- Press the USB button (15).

After the device has been connected, a content menu will display on the TV screen.

- Press the arrow button (up and down) to select a folder or a file.
- Press the ENTER button (26) to enter the selected folder or file. You can also use the digit buttons (2) to select a folder or to play the file.
- Press the arrow button (up and down) to select a folder or a file.
- Press ENTER (26) to confirm.
- Press the MENU button (27) to return to the content menu during playback.

During playback, the following functions are available:

- To select a track, press the PREV button (23) or the NEXT button (23) until the desired track is set.
- To pause playback, press the PLAY/PAUSE button (4) once; to resume playback, press the button again.
- To stop playback, press the STOP button (31).
- To remove the device, gently pull it out of the slot.



- Due to the great variety of products with USB ports and their sometimes quite manufacturer-specific functions we can neither guarantee that all devices will be recognised, nor that all operating options that are possible in theory will actually work.

6.6. LINE-IN

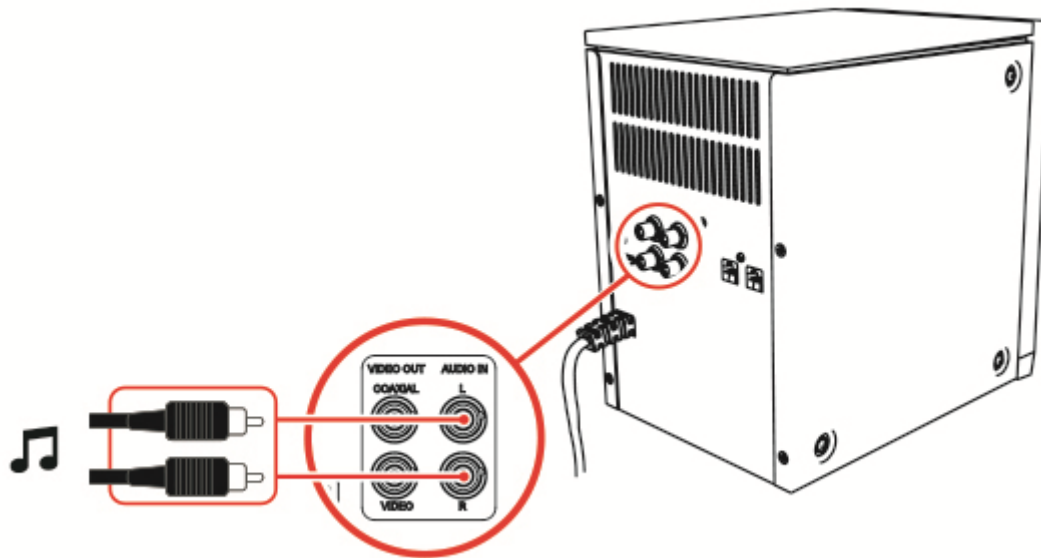

- Connect the external appliance to your AMD320 Microset.
- To select the source mode LINE-IN, press the SOURCE button (22).

6.7. Operation with BLUETOOTH

You can wirelessly connect the AMD320 to devices that have Bluetooth A2DP.

Establishing a Bluetooth connection (PAIREN)

- Turn on the Bluetooth function of your device
- To select the source mode BLUETOOTH, press the SOURCE button (22).
- Press and hold the button PLAY/ PAUSE (4) to activate the Bluetooth pairing mode.
- Search Bluetooth devices and select Akai AMD320 to establish connection
-



Enter "0000" when the player asks for the PIN code

- When the pairing succeeds, the LED display panel shows BT LINK.



NOTE: your Bluetooth connection has a range of approximately 8 metres
If you move outside the Bluetooth range, the connection will be automatically terminated.
We can not guarantee that all Bluetooth devices are compatible.
If you move outside the Bluetooth range, the connection will be automatically terminated.

7.Cleaning and maintenance



WARNING Before performing any cleaning or maintenance, switch off and unplug the appliance. Clean the outside of the appliance with a soft cloth. When the appliance is very dirty, dampen the cloth slightly with water and a neutral solution.

7.1. Handle and care of a disc

- Hold the disc with fingers. Hold the disc outer edge and/or the centre spindle hole. Do not touch the disc surface.
- Do not bend or press the disc. Do not expose the disc to direct sunlight or heating sources.
- Clean the disc surface with a soft, dry cleaning cloth. Wipe the disc surface gently, radially, from centre towards the outer edge.
- Do not apply thinner, alcohol, chemical solvent, or sprays when cleaning. Such cleaning fluids will permanently damage the disc surface.

8. Technical data

AMD320 Microset

Voltage: 100 - 240VAC / 60 Hz

Power consumption: 75W

Frequency response: +/- 1,5 dB (20Hz ~20KHz)

Speaker output: 2 x 15W RMS

Disc output

Television system: PAL/NTSC

Frequency range: 20Hz ~20KHz

Signal/noise ratio: >80dB (1kHz)

Dynamic range: >70dB (1kHz)

Distortion: < -60dB (1kHz)

Remote control

Battery size: AAA

Radio

Frequency range: 87,5~108 MHz

Supported media formats

Disc types: DVD / DVD+R(W) / DVD-R(W) / S (VDC) / CD / CD-R / CD-RW

Picture formats: JPEG / Kodak Picture CD

Video formats: MPEG-4 / DivX (USB) / Xvid

Video formats: MPEG - 4 / DivX (only via USB) / Xvid

Audio formats: MP3 / WMA

Working environment

Operating temperature: - 10 ~ +35 C(elsius)

Relative humidity: 5% ~90%

9. Disposal of used electrical and electronic equipment



The meaning of the symbol on the material, its accessory or packaging indicates that this product shall not be treated as household waste. Please, dispose of this equipment at your applicable collection point for the recycling of electrical and electronic equipments waste. In the European Union and Other European countries which there are separate collection systems for used electrical and electronic product. By ensuring the correct disposal of this product, you will help prevent potentially hazardous to the environment and to human health, which could otherwise be caused by unsuitable waste handling of this product. The recycling of materials will help conserve natural resources. Please do not therefore dispose of your old electrical and electronic equipment with your household waste.

For more detailed information about recycling of this product, please contact your local city office, your household waste disposal service or the shop where you purchased the product.

For more information and warranty conditions, please visit: www.akai.eu



Do not dispose of batteries as household waste but take them to a battery recycling facility.