



AMC306  
Microset

**AKAI**

- EN For more information see [www.akai.eu](http://www.akai.eu)
- NL Voor meer informatie zie [www.akai.eu](http://www.akai.eu)
- D Für weitere Informationen siehe [www.akai.eu](http://www.akai.eu)
- F Pour plus d'informations, veuillez consulter le site [www.akai.eu](http://www.akai.eu)
- E Para más información, visite [www.akai.eu](http://www.akai.eu)
- DK For mere information besøg [www.akai.eu](http://www.akai.eu)
- FI Lisätietoja löydät osoitteesta [www.akai.eu](http://www.akai.eu)



## 1 Check the contents

Controleer de inhoud  
Kontrollieren Sie den Inhalt  
Vérifiez le contenu  
Revise el contenido  
Kontroller indholdet  
Tarkista sisältö

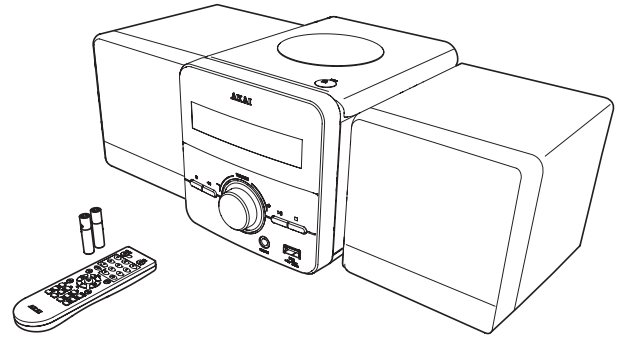

## 2 Connect the speakers to the appliance

Sluit de luidsprekers aan op het apparaat  
Verbinden Sie die Lautsprecher mit dem Gerät  
Connectez l'appareil aux haut-parleurs  
Conecte los altavoces al aparato  
Tilslut højttalerne på apparatet  
Liitä kaiuttimet laitteeseen

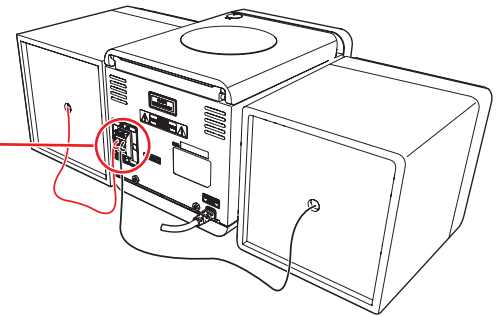
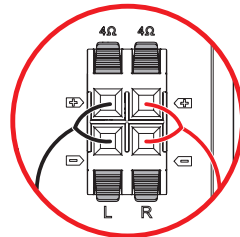

## 3 Uncoil the FM antenna as far as possible

Rol de FM-antenne zo ver mogelijk uit  
Fahren Sie die FM-Antenne so weit wie möglich aus  
Déroulez le plus possible l'antenne FM  
Extienda la antena FM el máximo posible  
Kør FM-antennen så langt ud som muligt  
Vedä FM-antenni mahdollisimman pitkälle ulos.

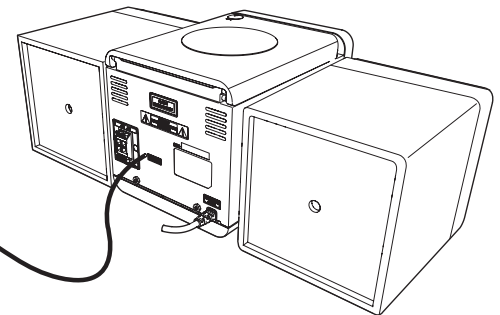
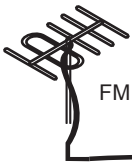

## 4 Connect to the mains

Sluit aan op het lichtnet  
Schließen Sie Netzspannung an  
Raccordez au réseau électrique  
Conecte a la red eléctrica  
Tilslut til lysnettet  
Kytke verkkovirtaan

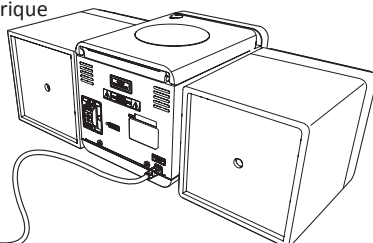
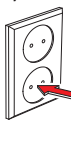

## 5 Turn on the device

Schakel het apparaat in  
Schalten Sie das Gerät ein  
Mettez l'appareil en marche  
Encienda el aparato  
Tænd for apparatet  
Kytke laite toimintaan

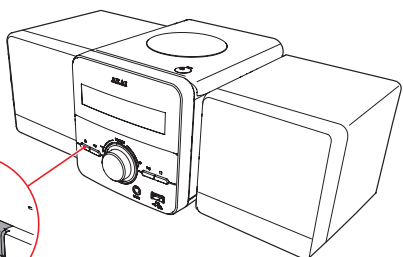
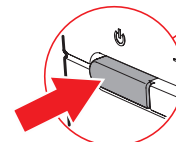

6

## Insert the batteries

Plaats de batterijen  
Legen Sie die Batterien ein  
Placez les piles  
Coloque las pilas  
Sæt batteriet i  
Paristojen asettaminen



7

## Remote control

Afstandsbediening  
Fernbedienung  
Télécommande  
Mando a distancia  
Fjernbetjening  
Kaukosäädin

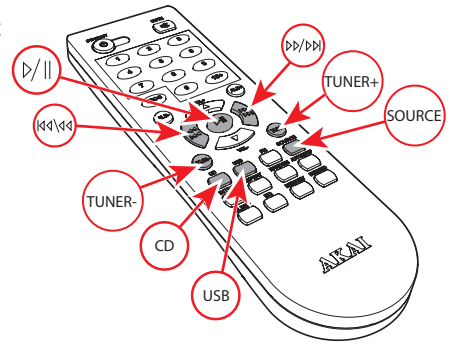

8

## The button SOURCE

De toets SOURCE  
Die Taste SOURCE  
La touche SOURCE  
Los botones SOURCE  
Knappen SOURCE  
Painike SOURCE

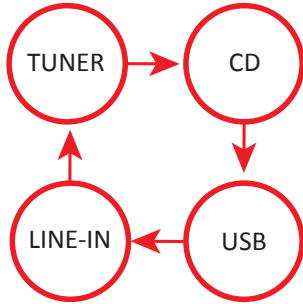

9

## TUNER functions

TUNER functies  
TUNER-Funktionen  
Fonctions TUNER  
Funciones del TUNER  
TUNER-funktioner  
TUNER-toiminnot

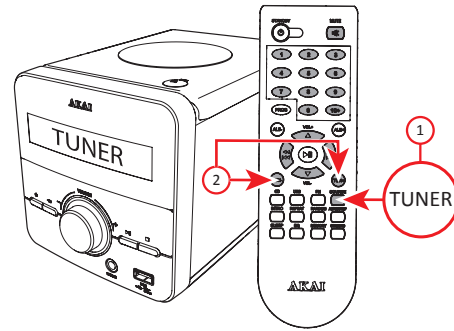

10

## CD functions

CD functies  
CD-Funktionen  
Fonctions CD  
Funciones del CD  
CD-funktioner  
CD-toiminnot

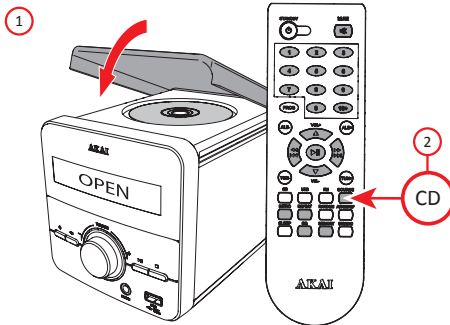

11

## LINE IN connection

LINE IN aansluiting  
Buchse LINE IN  
Connexion LINE IN  
Conexión LINE IN  
LINE IN-tíslutning  
LINE IN-liitäntä

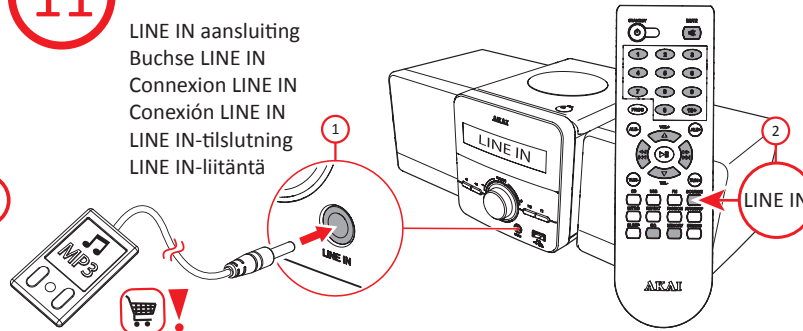

12

## USB slot

USB aansluiting  
USB Anschluss  
Port USB  
Conexión USB  
USB tíslutning  
USB-liitäntä

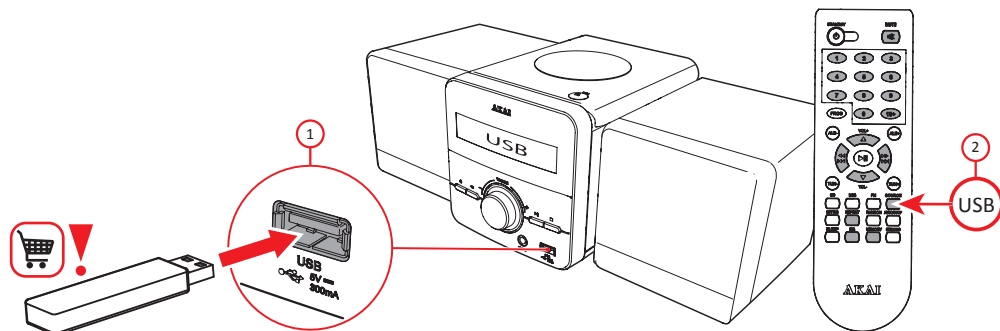

### Specifications

Compatible with CD/  
CD-R/CD-RW/MP3  
Remote control  
FM tuner, frequency range:  
87,5 - 108 MHz  
Line in jack: 3,5 mm  
USB slot  
Speaker output:  
2 x 2,5W RMS  
Impedance: 8Ω 3W  
AC 100-240V ~ 50/60Hz  
Power consumption: 10W  
Standby power consumption:  
<0,5W  
Frequency response: 3dB

### Specificaties

Geschikt voor CD/  
CD-R/CD-RW/MP3  
Afstandsbediening  
FM-tuner, frequentiebereik:  
87,5 - 108 MHz  
Line-in aansluiting: 3,5 mm  
USB aansluiting  
Luidspreker output:  
2 x 2,5W RMS  
Impedantie: 8Ω 3W  
AC 100-240V ~ 50/60Hz  
Energieverbruik: 10W  
Energieverbruik standby:  
<0,5W  
Frequentierespons: 3dB

### Technische Daten

Geeignet für CD/ CD-R/CD-  
RW/MP3  
Fernbedienung  
FM-Tuner, Frequenz-bereich:  
87,5 - 108 MHz  
Line in-Buchse: 3,5 mm  
USB Anschluss  
Lautsprecher-Output:  
2 x 2,5W RMS  
Impedanz: 8Ω 3W  
AC 100-240V ~ 50/60Hz  
Energieverbrauch: 10W  
Leistungsaufnahme im  
Standby-Betrieb: <0,5W  
Frequenzgang: 3dB

### Spécifications

Adapté pour CD/  
CD-R/CD-RW/MP3  
Télécommande  
FM-Tuner, Plage de fréquence:  
87,5 - 108 MHz  
Prise entrée de ligne: 3,5 mm  
Port USB  
Sortie haut-parleur:  
2 x 2,5W RMS  
Impédance: 8Ω 3W  
AC 100-240V ~ 50/60Hz  
Consommation électrique:  
10W  
Consommation électrique en  
veille: <0,5W  
Réponse en fréquence: 3dB

### Especificaciones

Compatible con CD/  
CD-R/CD-RW/MP3  
Mando a distancia  
Sintonizador FM,  
Intervalo de frecuencia:  
87,5 - 108 MHz  
Toma de entrada de línea: 3,5  
mm  
Conexión USB  
Salida-altavoz: 2 x 2,5W RMS  
Impedancia: 8Ω 3W  
AC 100-240V ~ 50/60Hz  
Consumo de energía: 10W  
Consumo de energía en espera  
activa: <0,5W  
Respuesta en frecuencia: 3dB

### Specifikationer

Egnet til CD/ CD-R/  
CD-RW/MP3  
Fjernbetjening  
FM-tuner, Frekvensområde:  
87,5 - 108 MHz  
Line-in stik: 3,5 mm  
USB tilslutning  
Højttaler-output:  
2 x 2,5W RMS  
Impedans: 8Ω 3W  
AC 100-240V ~ 50/60Hz  
Energiforbrug: 10W  
Energiforbrug på stand-by:  
<0,5W  
Frekvensrespons: 3dB

### Tekniset tiedot

Yhteensopivuus CD/  
CD-R/CD-RW/MP3  
Kaukosäädin  
FM-viritin, Taajuusalue: 87,5 -  
108 MHz  
Linjalähti: 3,5 mm  
USB -liitäntä  
Käytinlähti:  
2 x 2,5W RMS  
Impedanssi: 8Ω 3W  
AC 100-240V ~ 50/60Hz  
Tehonkulutus: 10W  
Valmiustilan virrankulutus:  
<0,5W  
Taajuusvaste: 3dB