

AKAI

LED TV / DVD COMBI WITH DVB-T TUNER

ALED1907TBK



Handleiding

User manual

Manuel de l'utilisateur

1

42

80

Contents

Features	45	Configuring Picture Settings	62
Introduction	45	Operating Picture Settings Menu Items	62
Preparation	45	Picture Settings Menu Items	62
Safety Precautions	45	PC Picture Settings	63
Power	45	Configuring Sound Settings	63
Information for users in the EU	46	Operating Sound Settings Menu Items	63
Package Contents	47	Sound Settings Menu Items	63
Environmental Information	48	Configuring Your TV's Settings	64
Repair Information	48	Operating Settings Menu Items	64
Remote Control Buttons	49	Settings Menu Items	64
TV and Operating Control Switch	50	Using a Conditional Access Module (not included)	64
Viewing the Connections - Back Connectors	50	Viewing Conditional Access Menu (*)	64
Viewing the Connections - Side Connectors	51	Configuring Language Preferences	65
Power Connection	51	Language Settings	65
Using USB Media	52	Parental Control	65
USB Memory Connection	52	Parental Settings Menu Operation	66
Connecting the TV to a PC	52	Timers	66
Using Side AV Connectors	52	Configuring Date/Time Settings	67
Connecting to a DVD Player via HDMI	53	Configuring Source Settings	67
Connecting to a DVD Player	53	Configuring Other Settings	68
Remote Control Handset	53	Operation	68
Inserting Batteries	53	Other Features	68
Switching On/Off	54	Teletext	69
To Switch the TV On	54	Tips	69
To Switch the TV Off	54	Appendix A: PC Input Typical Display Modes	70
Input Selection	54	Appendix B: AV and HDMI Signal Compatibility (Input Signal Types)	70
Basic Operations	54	Appendix C: Supported DVI Resolutions	71
Viewing Electronic Programme Guide (EPG)	55	Appendix D: Software Upgrade	71
First Time Installation	56	Appendix E : Supported File Formats for USB Mode	72
Installation	56	Specifications	73
Auto Channel Scan (Retune) Menu Operation	57	MOBIL TV INSTRUCTION MANUAL	74
Manual Tuning	57		
Digital Manual Search	57		
Analogue Manual Search	57		
Analogue Fine Tune	57		
Managing Stations: Channel List	57		
Operating the Channel List	58		
Moving a Channel	58		
Deleting a Channel	58		
Renaming a Channel	58		
Locking a Channel	58		
Managing Stations: Favourites	58		
Button Functions	58		
Managing Stations: Sorting the Channel List	59		
On-Screen Information	59		
Media Playback Using Media Browser	59		
Viewing Photos via USB	60		
Media Browser Settings	61		
Changing Image Size: Picture Formats	61		
Cinema	62		

Features

- Remote controlled colour LED TV.
- Fully integrated Terrestrial digital-cable TV (DVB-T MPEG2)
- HDMI connectors for digital video and audio.
- USB input.
- 1000 programmes (analogue+digital).
- On Screen Display (OSD) menu system.
- Integrated tuner DVB-T, MPEG2 compatible.
- Scart socket for external devices.
- Stereo sound system. (German+Nicam)
- Teletext, fastext, TOP text.
- Headphone connection.
- Automatic programming system.
- Forward or backward manual tuning.
- Sleep timer / Child lock.
- Automatic sound mute when no transmission.
- NTSC playback.
- AVL (Automatic Volume Limiting).
- Auto power down.
- PLL (Frequency Search).
- PC input.
- Plug&Play for Windows 98, ME, 2000, XP, Vista, Windows 7.
- Game Mode.

Introduction

Thank you for choosing this product. This manual will guide you through the proper operation of your TV. Before operating the TV, please read this manual thoroughly. Please keep this manual in a safe place for future reference.

This device is intended to receive and display TV programmes. The different connection options make an additional expansion of the reception and display sources possible (receiver, DVD player, DVD recorder, VCR, PC etc.).

This device is only suitable for dry indoor use. This appliance is intended solely for private domestic use and may not be used for industrial and commercial purposes. We exclude liability in principle, if the device is not used as intended, or unauthorized modifications have been made. To operate your LED TV in extreme ambient conditions may cause the damage of the device.

Preparation

For ventilation, leave a free space of at least 10 cm all around the set. To prevent any fault and unsafe situations, please do not place any objects on top of the set. Use this device in moderate climates.

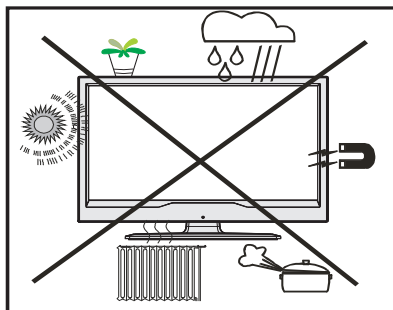

Safety Precautions

Read the following recommended safety precautions carefully.

Power

- Always use the provided AC adaptor.
- Operate only from the power source specified on the AC adaptor.
- The power adaptor may become hot during normal operation. This is not a malfunction.
- Please make sure that the adaptor is not covered while in operation. Leave a space of 15 cm (minimum) around the AC adaptor.
- The rating information and safety caution of the AC adaptor are provided on the adaptor.

WARNING: When the set is not in use for a long time, disconnect from the power.

Power Cord

Do not place the set, a piece of furniture, etc. on the power cord or pinch the cord. Handle the power cord by the plug. Do not unplug the appliance by pulling from the power cord and never touch the power cord with wet hands as this could cause a short circuit or electric shock. Never make a knot in the cord or tie it with other cords. The power cord should be placed in such a way that they are not likely to be stepped on. A damaged power cord can cause fire or give you an electric shock. When it is damaged and needs to be replaced, it should be done by qualified personnel.

Moisture and Water

Do not use this device in a humid and damp place (avoid the bathroom, the sink in the kitchen etc). Do not expose this device to rain or water, as this may be dangerous and do not place objects filled with liquids, such as flower vases, on top.



If any solid object or liquid falls into the cabinet, unplug the TV and have it checked by qualified personnel before operating it any further.

Cleaning

Before cleaning, unplug the TV set from the wall outlet. Do not use liquid or aerosol cleaners. Use a soft, dry cloth.



Ventilation

The slots and openings on the TV set are intended for ventilation and to ensure reliable operation. To prevent overheating, these openings must not be blocked or covered in anyway.

Heat and Flames

The set should not be placed near to open flames or sources of intense heat such as an electric heater. Ensure that no open flame sources, such as candles, are placed on top of the TV. Batteries should not be exposed to excessive heat such as sunshine, fire or the like.



Lightning

In case of storm and lightning or when going on holiday, disconnect the power cord from the wall outlet.

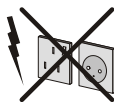

Replacement Parts

When replacement parts are required, make sure that the service technician has used replacement parts, which are specified by the manufacturer or have the same specifications as the original one. Unauthorized

substitutions may result in fire, electrical shock or other hazards.

Servicing

Please refer all servicing to qualified personnel. Do not remove the cover yourself as this may result in an electric shock.



Waste Disposal

Instructions for waste disposal:

- Packaging and packaging aids are recyclable and should principally be recycled. Packaging materials, such as a foil bag, must be kept away from children.
- Batteries, including those which are heavy metal-free, should not be disposed of with household waste. Please dispose of used batteries in an environmentally friendly manner. Find out about the legal regulations which apply in your area.
- Do not try to recharge batteries, there is a danger of explosion. Replace batteries only with the same or equivalent type.

Information for users in the EU

This symbol on the product or on its packaging means that your electrical device should be disposed at the end of its service life separately from your household wastes. There are separate collection systems for recycling in the EU. For more information, please contact the local authority or the dealer where you purchased the product.



Disconnecting the Device

The mains plug is used to disconnect the TV set from the mains and therefore it must remain readily operable.

Headphone Volume

Excessive sound pressure from earphones and headphones can cause hearing loss.



Installation

To prevent injury, this device must be securely attached to the wall in accordance with the installation instructions when mounted to the wall (if the option is available).

LCD Screen

The LCD panel is a very high technology product with about a million thin film transistors, giving you fine picture details. Occasionally, a few non-active pixels may appear on the screen as a fixed blue, green or red point. Please note that this does not affect the performance of your product.

Warning! Do not leave your TV in standby or operating mode when you leave your house.

Connection to a Television Distribution System (Cable TV etc.) from Tuner

Devices connected to the protective earthing of the building installation through the mains connection or through other apparatus with a connection to protective earthing-and to a television distribution system using a coaxial cable, may in some circumstances create a fire hazard.

Connection to a cable distribution system has therefore to be provided through a device providing electrical isolation below a certain frequency range (galvanic isolator, see EN 60728-11).

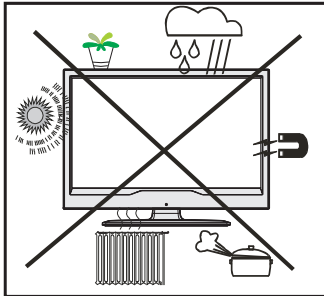

Electrical devices not in the hands of children

Never let children use electrical devices unsupervised. Children cannot always recognize properly any possible danger. Batteries / accumulators can be life threatening when swallowed. Store batteries out of the reach of small children. In case of swallowing a battery, medical aid has to be sought immediately. Also keep the packaging away from children as there is danger of suffocation.

The Standby button does not fully switch off this product. Moreover, the device continues to consume power in standby mode. In order to separate the device completely from mains, the mains plug has to be pulled from the mains socket. Because of that the device should be set up in a way, that an unobstructed access to the mains socket is guaranteed, so that in case of emergency the mains plug can be pulled immediately. During periods of prolonged non-use, the TV should be disconnected from the mains power supply.

TRADEMARK ACKNOWLEDGMENT

"Dolby" and the double-D symbol are trademarks of Dolby Laboratories.



Licence Notification (Optional)

Manufactured under license from Dolby Laboratories.

Package Contents

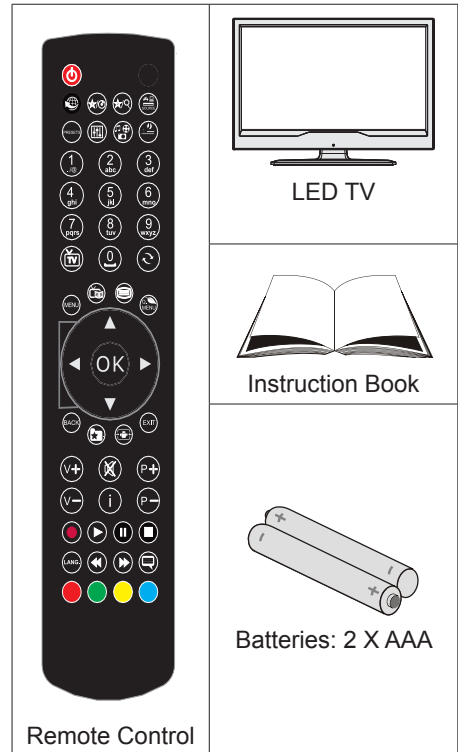

Note: You should check the contents after opening your purchase and make sure that every item is included.

Note: The HDMI connection between PC and TV may cause radio interference in which case it is recommended to use VGA(DSUB-15) connection.

Environmental Information

- This television is designed to consume less energy to save the environment.

You not only help to save the environment but you can also save money by reducing electricity bills thanks to the energy efficiency features of this TV. To reduce energy consumption, you should take the following steps:

- You can use the Power Save Mode setting, located in the **Other settings** menu. If you set the Power Save Mode as On, the TV will switch to energy-saving mode and the luminance level of the TV set will be decreased to optimum level. Note that some picture settings will be unavailable when the TV is in Power Save Mode.

Power Save Mode

< Off >

- When the TV is not in use, please switch off or disconnect the TV from the mains plug. This will also reduce energy consumption.
- Note that annually, using the TV set in Power Save Mode has more power efficiency than disconnecting the TV from the mains plug instead of keeping stand-by mode. Therefore it is highly recommended to activate Power Save Mode setting to reduce your annual power consumption. And also it is recommended to disconnect the TV from the mains plug to save energy more when you do not use.
- Please helps us to save environment by following these steps.

Repair Information

Please refer all servicing to qualified personnel. Only qualified personnel must repair the TV. Please contact your local dealer, where you purchased this TV for further information.

Be sure to ground the connection properly.

Connect the ground terminal of the AC adaptor with the ground terminal provided at the power outlet using the enclosed power cord. If the provided plug does not fit your outlet, consult an electrician for replacement of the obsolete outlet.



Surely connect the ground wire

Remote Control Buttons

1. Standby
2. No Function
3. No Function
4. Changes equalizer modes
5. Picture mode selection
6. Numeric buttons
7. TV Button
8. Electronic programme guide
9. Menu
10. Navigation buttons (Up/Down/Left/(Right-TXT Subpage)
11. Back
12. Favourites
13. Volume Up / Down
14. Info / Reveal (in TXT mode)
15. No Function
16. Play
17. Mono/Stereo - Dual I-II / Current Language (*) / Play preview (in Media Browser mode)
18. Rapid reverse (in Media Browser mode)
19. Red button / IDTV Page up
20. Green button / IDTV Page down
21. My button 2
22. Source selection
23. Sleep timer
24. Media browser
25. Previous programme / Now (in EPG mode)
26. Teletext/Mix
27. Q. Menu
28. OK / Select / Hold (in TXT mode) / Channel List (DTV mode)
29. Exit / Return / Index page (in TXT mode)
30. Image size / Zooms videos (in Media Browser video mode)
31. Mute
32. Program Up / Down
33. Pause
34. Stop
35. Subtitle on-off / TXT subtitle (analogue TVmode) / Subtitle (in Media Browser mode).
36. Rapid advance (in Media Browser mode)
37. Blue button
38. Yellow button

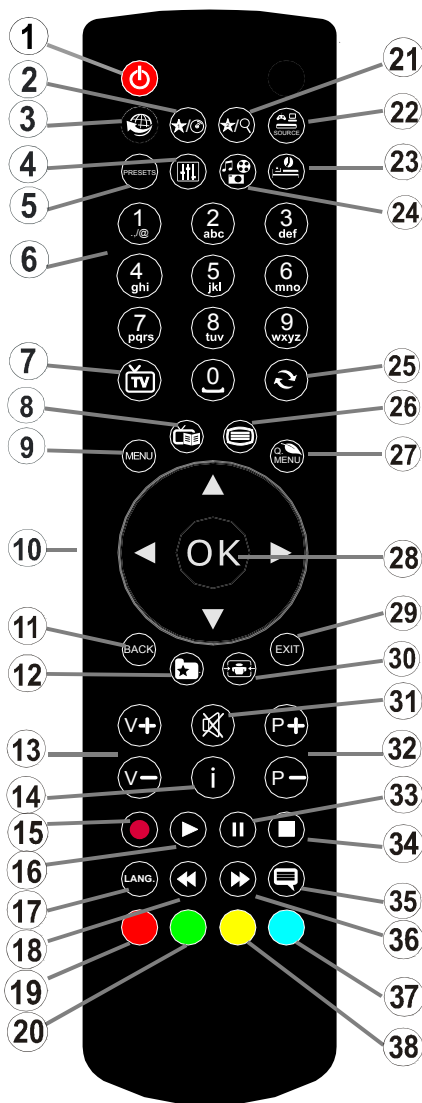

TV and Operating Control Switch

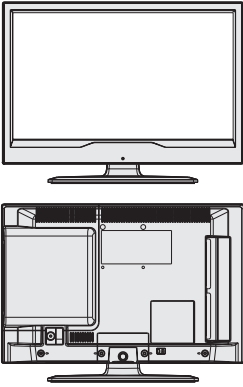
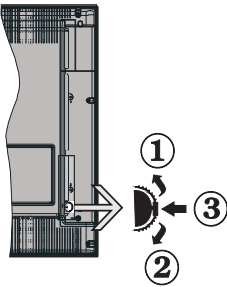
FRONT and REAR VIEW	Control switch VIEW	Control Switch
		<ol style="list-style-type: none"> 1. Up direction 2. Down direction 3. Programme/Volume / AV / Standby-On selection switch <p><i>Note: You can move the switch, upward or downward to change the volume. If you want to change channels, press the middle of the switch once (Position 3) and then move upward or downward. If you press the middle of the switch once more, source OSD will be displayed. If you press the middle of the switch and hold about a few seconds, the TV will switch to standby mode. Main menu OSD cannot be displayed via control buttons.</i></p>

Viewing the Connections - Back Connectors

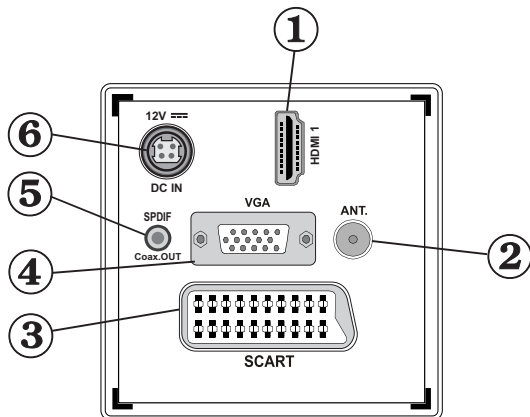

1. HDMI 1: HDMI Input

HDMI Inputs are for connecting a device that has a **HDMI** socket. Your TV is capable of displaying High Definition pictures from devices such as a High Definition Satellite Receiver or DVD Player. These devices must be connected via the HDMI sockets or Component Socket. These sockets can accept either 720p or 1080i signals. No sound connection is needed for a HDMI to HDMI connection.

2. RF Input connects to an aerial antenna system.

Note: If you use a decoder or a media recorder, you should connect the aerial cable through the device to the television with an appropriate antenna cable, as shown in the illustration in the following pages.

3. SCART input or output for external devices. Connect the SCART cable between SCART socket on TV and SCART socket on your external device (such as a decoder, a VCR or a DVD player).

Note: If an external device is connected via the SCART socket, the TV will automatically switch to AV mode.

Note: S-VHS signal is supported via the scart socket (optional).

4. VGA Input is for connecting a personal computer to the TV set.

Connect the PC cable between the **PC INPUT** on the TV and the PC output on your PC.
Note: You can use YPbPr to VGA cable (not supplied) to enable YPbPr signal via VGA input.
WARNING: You cannot use VGA and YPbPr at the same time.

5. **SPDIF Out** outputs audio signals of the currently watched source. Use an **SPDIF cable** to transfer audio signals to a device that has SPDIF input.
6. **DC 12 V Input** is used for connecting the supplied power adaptor. 

Viewing the Connections - Side Connectors

1. CI Slot is used for inserting a CI card. A CI card allows you to view all the channels that you subscribe to. For more information, see "Conditional Access" section.
2. Side USB input.
Note that programme recording feature is available via this USB input. You can connect external hard disk drives to this input.
3. Video Input is used for connecting video signals of external devices. Connect the video cable between the VIDEO IN socket on the TV and the VIDEO OUT jack on your device.
4. Audio Inputs are used for connecting audio signals of external devices. Connect the audio cable between the AUDIO INPUTS on the TV and the AUDIO OUTPUT jacks on your device.
Note: If you connect a device to the TV via the VIDEO INPUT, you should also connect your device with an audio cable to the AUDIO INPUTS of the TV to enable audio.
5. Headphone jack is used for connecting an external headphone to the system. Connect to the HEADPHONE jack to listen to the TV from headphones (optional).
6. Volume/ Programme/ Source and Standby-On switch.

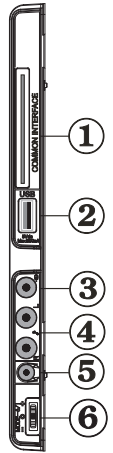

Power Connection

IMPORTANT: The TV set is designed to operate on 12 V DC. For this, an adaptor is used which gives 12 V voltage. Connect this adaptor to a system that supplies 110-240V AC, 50/60Hz.

- After unpacking, allow the TV set to reach the ambient room temperature before you connect the set to the mains.

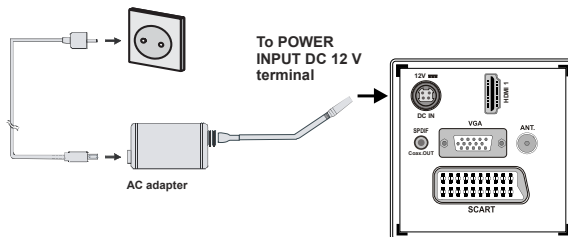

Using USB Media

- You can connect USB devices to your TV by using the USB input of the TV. This feature allows you to display/play JPG, MP3 and video files stored on a USB stick.
- It is possible that certain types of USB devices (e.g. MP3 Players) may not be compatible with this TV.
- You should back up your files before making any connections to the TV set in order to avoid any possible data loss. Note that the manufacturer will not be responsible for any file damage or data loss.
- Do not pull out USB module while playing a file.

CAUTION: Quickly plugging and unplugging USB devices, is a very hazardous operation. Do not repeatedly quickly plug and unplug the drive. This may cause physical damage to the USB player and especially the USB device itself.

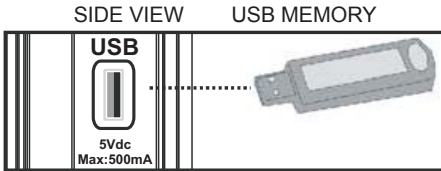

USB Memory Connection

IMPORTANT: The TV should be switched off while plugging or unplugging a USB device. Plug your USB devices to the USB input of the TV. You can connect a USB device to your TV by using the USB input of the TV.

Note: It is possible certain types of hard disk drives are not supported.

Connecting the LCD TV to a PC

For displaying your computer's screen image on your LCD TV, you can connect your computer to the TV set. Power off both computer and display before making any connections. Use 15-pin D-sub display cable to connect a PC to the LCD TV. When the connection is made, switch to PC source. See **Input selection** section. Set the resolution that suits your viewing requirements. Resolution information can be found in the appendix parts

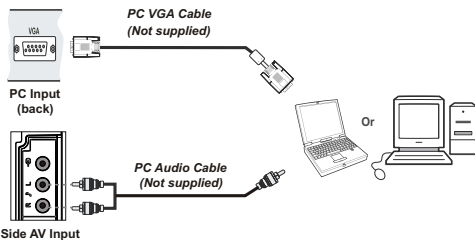

Note: If you connect a PC to the TV using HDMI connection, radio interference may occur. Therefore this type of connection is not recommended. You should use VGA connection instead.

Using Side AV Connectors

You can connect a range of optional equipment to your TV using the side connectors of the TV.

- For connecting a camcorder, connect to the VIDEO IN socket and the AUDIO SOCKETS. Do not connect the camcorder to VIDEO IN socket at the same time since it can cause noise in the picture. For selecting the related source, see the section "Input selection" in the following parts.
- Afterwards, you should switch to **Side AV** source. See the section **Input selection** in the following sections for more information.

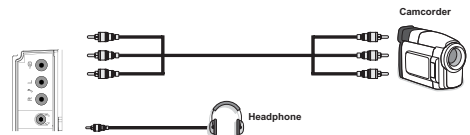

- To listen the TV sound from headphones, you should connect headphones to your TV by using the **HEADPHONE** jack as illustrated above.

Connecting to a DVD Player via HDMI

Please refer to your DVD player's instruction book for additional information. Power off both the TV and the device before making any connections.

Note: Not all cables shown in the illustration are supplied.

- If your DVD player has an **HDMI** socket, you can connect via **HDMI** for better video and audio quality.

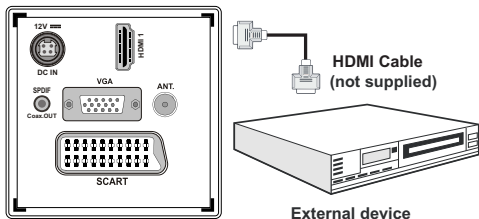

- When you connect to DVD player as illustrated above, switch to the connected **HDMI** source. See, **Input Selection** section for more information on changing sources.

Connecting to a DVD Player

- Some DVD players are connected through **COMPONENT SOCKETS (YPbPr)**. YPbPr can be used only when you connect a device that has a YPbPr output through the PC input with YPbPr to PC cable (YPbPr cable is not supplied).
- When the connection is made, switch to YPbPr source. See, "Input selection" section.
- To enable audio connection, use the **VGA/Component Audio cable**. First, plug single jack of the cable to the TV. Afterwards, insert your DVD player's audio cable's connectors into the plural part of the **VGA/Component audio connection cable** (see illustration below). Colours of the connected jacks should match (**RED & WHITE**).

Audio Connection

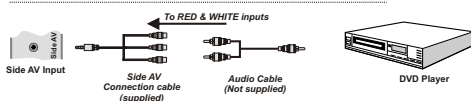

Video Connection

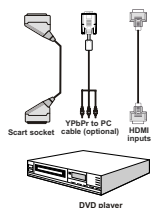

- When the connection is made, switch to **YPbPr** source. See, **Input selection** section.
- You may also connect through the **SCART** input.

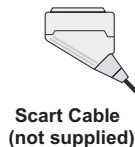
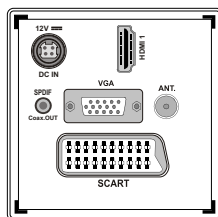

Note: These three methods of connection perform the same function but in different levels of quality. It is not necessary to connect by all three methods.

Remote Control Handset

Inserting Batteries

- Remove the battery cover located on the back of the handset by gently pulling backwards from the indicated part.
- Insert two **AAA/R3** or equivalent type batteries inside. Observe the correct polarity (+/-) when inserting batteries and replace the battery cover.



Note: Remove the batteries from the remote control handset when it is not to be used for a long period. Otherwise it can be damaged due to any leakage of batteries. Remote range is approximately 7m/23ft.

Switching On/Off

To Switch the TV On

- Connect the power cord to the 110-240V AC, 50/60 Hz.
- Press STANDBY touch button. Then the standby LED lights up.
- To switch on the TV from standby mode either:
 - Press the “” button, **P+** or **P-** or a numeric button on the remote control.
 - Press the control switch right side of the TV. The TV will then switch on.

*Note: If you switch on your TV via **P+** or **P-** buttons on the remote control or on the TV set, the programme that you were watching last will be reselected.*

By either method the TV will switch on.

To Switch the TV Off

- Press the “” button on the remote control or hold the control switch on the Tv until shut down , so the TV will switch to standby mode.
- To power down the TV completely, unplug the power cord from the mains socket.

Note: When the TV is switched to standby mode, the standby LED can blink to indicate that features such as Standby Search, Over Air Download or Timer is active.

Digital Teletext

- Press the “” button.
- The digital teletext information appears.
- Operate it with the coloured buttons, cursor buttons and **OK** button.

The operation method may differ depending on the contents of the digital teletext.

Follow the instructions displayed on the digital teletext screen.

- When the “” button is pressed, the TV returns to television broadcasting.
- The aspect ratio (picture shape) when watching a channel with just digital teletext broadcasting is the same as the aspect ratio of the picture viewed previously.

Input Selection

Once you have connected external systems to your TV, you can switch to different input sources. Press “**SOURCE**” button on your remote control consecutively for directly changing sources.

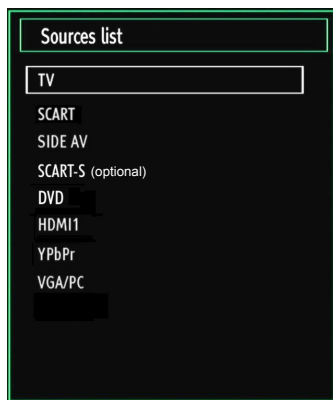

Note: YPbPr mode can be used only when you connect a device that has a YPbPr output through the PC input with YPbPr to PC cable (not supplied).

Basic Operations

You can operate your TV using both the remote control and onset buttons.

Operation with the Buttons on the TV

Volume Setting

- You can move the control switch upward or downward for changing the volume. To increase volume, please move the switch upward. Move the switch downward to decrease the volume. A volume level scale (slider) will be displayed on the screen.

Programme Selection

- First press the control switch once to change channel. You can move the switch upward to select the next programme or move it downward to select the previous programme.

Viewing Main Menu

- Menu screen cannot be displayed by using the control switch.

AV Mode

- Press the control switch consecutively until the source OSD is displayed on the screen.

Operation with the Remote Control

- The remote control of your TV is designed to control all the functions of the model you selected. The functions will be described in accordance with the menu system of your TV.

Volume Setting

- Press “**V+**” button to increase the volume. Press “**V-**” button to decrease the volume. A volume level scale (slider) will be displayed on the screen.

Programme Selection (Previous or Next Programme)

- Press “**P-**” button to select the previous programme.
- Press “**P+**” button to select the next programme.

Programme Selection (Direct Access)

- Press the numeric buttons on the remote control to select programmes between 0 and 9. The TV will switch to the selected programme.

Viewing Electronic Programme Guide (EPG)

You can view the electronic programme guide (EPG) to see information about available programmes. To view the EPG menu please press  button on the remote control.

- Press “**▼**”/“**▲**” buttons to navigate through channels.
- Press “**◀**”/“**▶**” buttons to navigate through the programme list.
- Please note that event information is updated automatically. If there is no event information data available for channels, the EPG will be displayed with blanks.



Channels	Current Event	Next Event
1. BBC ONE	Holby City	Hustle
2. BBC TWO	Springwatch	Mary, Queen of Shops
7. BBC THREE	Filthy Rich and Homeless	Bust My Ass
70. CBBC Channel	This is CBBC!	This is CBBC!
80. BBC NEWS 24	BBC News	BBC News
105. BBC	BBC	BBC
503. ITV HD Trial	No Information	No Information
504. Ch4 HD Trial	No Information	No Information
505. five HD Trial	No Information	No Information
800. Sky News	No Information	No Information
801. CNBC Europe	No Information	No Information
802. TVSMONDE EUROPE	No Information	No Information

OK (Options): Displays programme options including “**Select Channel**” option.

INFO (Event Details): Displays the programmes in detail.

Green button: Programme schedule will be listed

Yellow button: Display EPG data in accordance with timeline schedule

Blue button (Filter): Views filtering options.

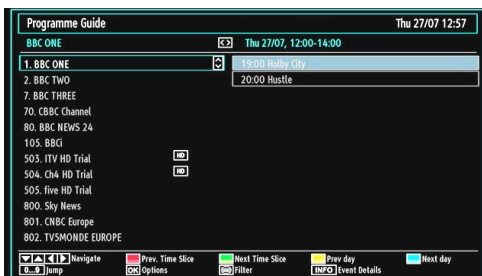

Channels	Current Event	Next Event
1. BBC ONE	Holby City	Hustle
2. BBC TWO	Springwatch	Mary, Queen of Shops
7. BBC THREE	Filthy Rich and Homeless	Bust My Ass
70. CBBC Channel	This is CBBC!	This is CBBC!
80. BBC NEWS 24	BBC News	BBC News
105. BBC	BBC	BBC
503. ITV HD Trial	No Information	No Information
504. Ch4 HD Trial	No Information	No Information
505. five HD Trial	No Information	No Information
800. Sky News	No Information	No Information
801. CNBC Europe	No Information	No Information
802. TVSMONDE EUROPE	No Information	No Information

Red button (Prev Time Slice): Displays the programmes of previous time slice.

Green button (Next Time Slice): Displays the programmes of the next time slice.

Yellow button (Prev Day): Displays the programmes of previous day.

Blue button (Next day): Displays the programmes of the next day.

Numeric buttons (Jump): Jumps to the preferred channel directly via numeric buttons.

OK (Options): Displays programme options including “**Select Channel**” option.

 **button (Filter):** Views filtering options.

INFO (Details): Displays the programmes in detail.



Channels	Current Event	Next Event
1. BBC ONE	Holby City	Hustle
2. BBC TWO	Springwatch	Mary, Queen of Shops
7. BBC THREE	Filthy Rich and Homeless	Bust My Ass
70. CBBC Channel	This is CBBC!	This is CBBC!
80. BBC NEWS 24	BBC News	BBC News
105. BBC	BBC	BBC
503. ITV HD Trial	No Information	No Information
504. Ch4 HD Trial	No Information	No Information
505. five HD Trial	No Information	No Information
800. Sky News	No Information	No Information
801. CNBC Europe	No Information	No Information
802. TVSMONDE EU	No Information	No Information

Red button (Prev Day): Displays the programmes of previous day.

Green button (Next day): Displays the programmes of the next day.

Yellow button (Zoom): Expands programme information.

Blue button (Filter): Views filtering options.

INFO (Details): Displays the programmes in detail.

Numeric buttons (Jump): Jumps to the preferred channel directly via numeric buttons.

OK (Options): Displays programme options including “**Select Channel**” option.

 **(Search):** Displays “**Guide Search**” menu.

SUBTTL: Press  button to view Select Genre menu. Using this feature, you can search the programme guide database in accordance with the genre. Info available in the programme guide will be searched and results matching your criteria will be listed.

 **(Now)** : Shows the current programme.

First Time Installation

IMPORTANT: Ensure that the aerial is connected and a Common Interface module is not inserted before switching on the TV for the first time installation.

- When the TV is operated for the first time, the installation wizard will guide you through the process. First, the language selection screen will be displayed:

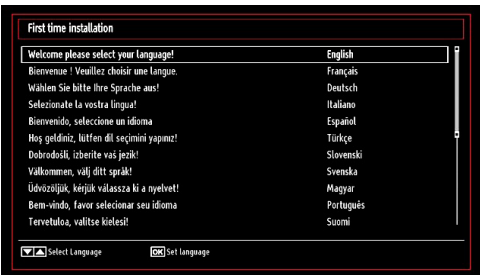

- Use “▼” or “▲” buttons to select your language and press **OK** button to set the selected language and continue.
- After selecting the language, “Welcome!” screen will be displayed, requiring you to set **Country**, **Search Type**, **Teletext Language** and **Scan Encrypted** options.

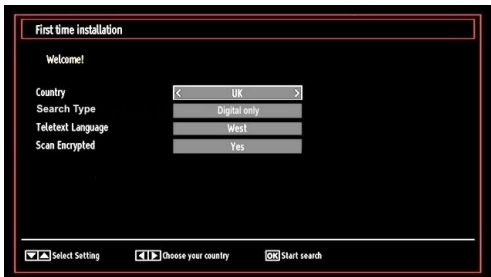

- By pressing “◀” or “▶” button, select the **country** you want to set and press “▼” button to highlight **Search Type** option. Use “◀” or “▶” to set the desired search type. Available search types are digital only, analog TV only and full.

- When set, press “▼” to select **Teletext Language**. Use “◀” or “▶” to select the desired **Teletext Language**.
- Press **OK** button on the remote control to continue and the following message will be displayed on the screen:



To select the “Yes” or “No” option, highlight the item by using “◀” or “▶” buttons and press **OK** button.

Afterwards the following OSD will be displayed on the screen and the TV will search for both digital and analogue TV broadcasts.

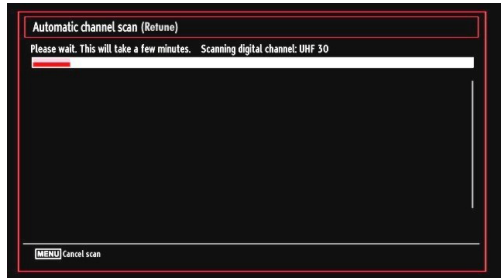

Note: You can press “**MENU**” button to cancel.

- After all the available stations are stored, Channel List will be displayed on the screen. If you like the sort channels, according to the LCN, please select “Yes” and then press “OK”.

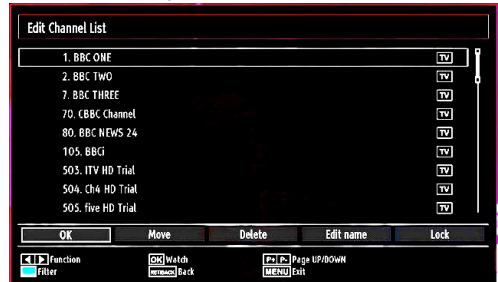

- Press **OK** button to quit channel list and watch TV.

Installation

Press “**MENU**” button on the remote control and select **Installation** by using “◀” or “▶” button. Press **OK** button and the following menu screen will be displayed.

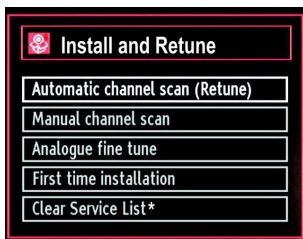

Select **Automatic Channel Scan (Retune)** by using “▼”/“▲” button and press **OK** button. **Automatic Channel Scan (Retune)** options will be displayed. You can select options by using “▼”/“▲” and **OK** buttons.

Auto Channel Scan (Retune) Menu Operation

Analogue: Searches and stores analogue stations.

Digital & Analogue: Searches and stores both analogue and aerial DVB stations.

- Whenever you select an automatic search type and press **OK** button, a confirmation screen will appear on the screen. To start installation process, select **Yes**, to cancel select **No** by using “◀” or “▶” and **OK** button.
- After the auto channel scan type is set and selected and confirmed, the installation process will start and the progress bar will move along. Press “**MENU**” button to cancel process. Located channels are not stored if the process is cancelled.

Manual Tuning

HINT: This feature can be used for direct broadcast entry.

- Select **Manual Channel Scan** from the Installation menu by using “▼”/“▲” and **OK** buttons. Manual Scan options screen will be displayed.
- Select the desired **Search Type** using “◀” or “▶” button. Manual search options will change accordingly. Use “▼”/“▲” button to highlight an item and then press “◀” or “▶” button to set an option. You can press “**MENU**” button to cancel.

Digital Manual Search

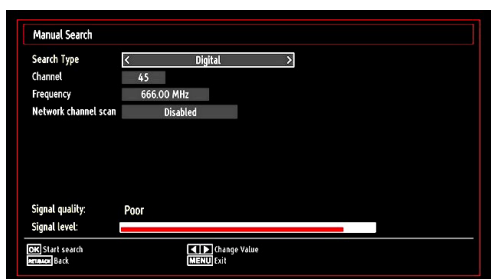

In manual channel scan, the number of the multiplex or frequency are entered manually and only that multiplex or frequency are searched for the channels. After selecting search type as **Digital**, you can enter the multiplex or frequency number using the numeric buttons and press **OK** button to search.

Analogue Manual Search

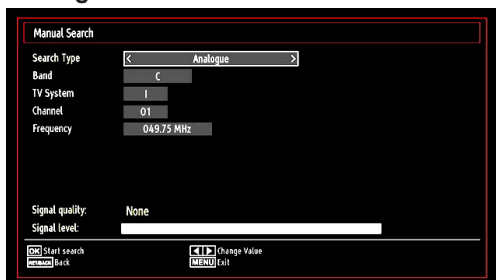

After selecting search type as analogue, you can use “▼”/“▲” button to highlight an item and then press “◀” or “▶” button to set an option.

Enter the channel number or frequency using the numeric buttons. You can then press **OK** button to search. When the channel is located, any new channels that are not on the list will be stored.

Analogue Fine Tune

- Select **Analogue Fine Tune** from the Installation menu by using “▼” or “▲” and **OK** buttons. The analogue fine tune screen will be displayed. The Analogue Fine Tune feature will not be available if there are no analogue channels, digital channels and external sources stored.
- Press **OK** button to proceed. Use “◀” or “▶” button to set Fine Tune. When finished, press **OK** button again.

Managing Stations: Channel List

The TV sorts all stored stations in the Channel List. You can edit this channel list, set favourites or set active stations to be listed by using the Channel List options.

- Press “**MENU**” button to view main menu. Select the Channel List item by using “◀” or “▶” button. Press **OK** to view menu contents.

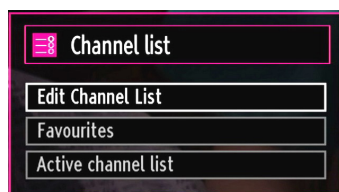

Select **Edit Channel List** to manage all stored channels. Use “◀” or “▶” and **OK** buttons to select Edit Channel List.

Operating the Channel List

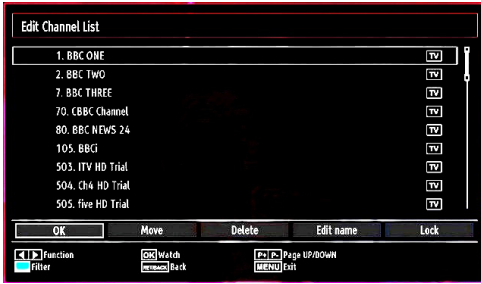

- Press “▼” or “▲” button to select the channel that will be processed. Press “◀” or “▶” button to select a function on Channel List menu.
- Use **P+** or **P-** buttons to move page up or down.
- Press **BLUE** button to view filtering options.
- Press “**MENU**” button to exit.

Moving a Channel

- First select the desired channel. Select Move option in the channel list and press the **OK** button.
- Edit Number screen will be displayed. Enter the desired channel number by using the numeric buttons on the remote control. If there is a previously stored channel on that number, a warning screen will be displayed. Select Yes if you want to move the channel and press **OK**.
- Press the **OK** button to process. Selected channel is now moved.

Deleting a Channel

You can press **GREEN** button to tag/untag all channels; **YELLOW** button to tag/untag channel.

- Select the channel that you want to delete and select **Delete** option. Press the **OK** button to continue.
- A warning screen will appear. Select **YES** to delete, select **No** to cancel. Press the **OK** button to continue.

Renaming a Channel

- Select the channel that you want to rename and select **Edit Name** option. Press **OK** button to continue.
- Pressing “◀” or “▶” button moves to the previous/next character. Pressing “▼” or “▲” button toggles the current character, i.e., ‘b’ character becomes ‘a’ by “▼” and ‘c’ by “▲”. Pressing the numeric buttons ‘0...9’ replaces the highlighted character with the characters printed above the button one by one as the button is pressed.
- When finished, press the **OK** button to save. Press “**MENU**” to cancel.

Locking a Channel

You can press **GREEN** button to tag/untag all channels; **YELLOW** button to tag/untag a single channel.

- Select the channel that you want to lock and select **Lock** option. Press **OK** button to continue.
- You will be asked to enter parental control PIN. Default PIN is set as **0000**. Enter the PIN number.



- Press **OK** button when the desired channel is highlighted to lock/unlock the channel. The Lock symbol will be displayed next to the selected channel.

Managing Stations: Favourites

You can create a list of favourite programmes.

- Press “**MENU**” button to view the main menu. Select Channel List item by using “◀” or “▶” button. Press **OK** to view menu contents.
- Select **Favourites** to manage favourite list. Use “▼”/“▲” and **OK** buttons to select **Favourites**.
- You can set various channels as favourites so that only the favourite channels are navigated.



- Select a channel by using “▼” or “▲” button. Press **OK** button to add selected channel to favourites list. Press **OK** button again to remove.

Button Functions

- **OK**: Add/remove a station.
- **YELLOW**: Tag/untag a channel.
- **GREEN**: Tag/untag all channels.
- **BLUE**: Displays filtering options.

Managing Stations: Sorting the Channel List

You can select broadcasts to be listed in the channel list. To display specific types of broadcast, you should use the Active channel list setting.

Select Active channel list from the Channel list menu by using “◀” or “▶” button. Press **OK** button to continue.

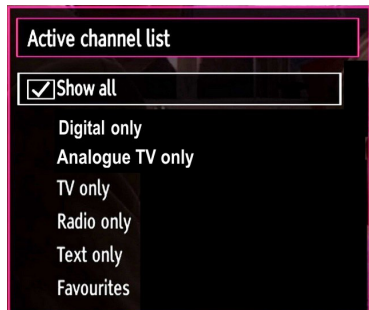

You can select a broadcast type option from the list by using “▼” / “▲” and **OK** buttons.

On-Screen Information

You can press “**i**” button to display on-screen information. Details of the station and current programme will be displayed on the information banner.



The information banner gives information on the channel selected and the programmes on it. The name of the channel is displayed, along with its channel list number.

Hint: Not all channels broadcast the programme data. If the name and time of the programme are not available, then the information banner will be displayed with blanks.

If the selected channel is locked, you must enter the correct four-digit numeric code to view the channel (default code is **0000**). “**Enter PIN**” will be displayed on the screen.

Media Playback Using Media Browser

If the USB stick is not recognized after power off/on or First Time Installation, unplug the USB device, turn the TV off and on again and re-insert the USB device.

To display the Media Browser window, press either “**MENU**” button on the remote control and then select Media Browser by pressing “◀” or “▶” button. Press **OK** button to continue. Media Browser menu options will be displayed.

Also, when you plug USB devices, media browser screen will be displayed automatically:

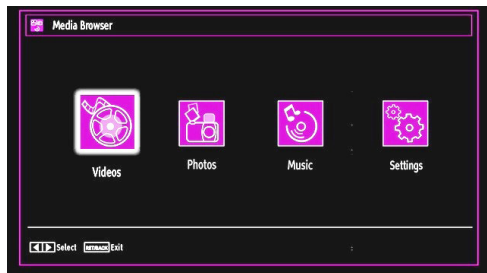

You can play music, picture and video files from the connected USB memory stick. Use “◀” or “▶” button to select Videos, Photos, Music or Settings.

Viewing Videos via USB

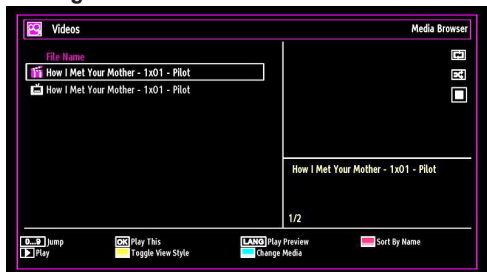

When you select Videos from the main options, available video files will be filtered and listed on this screen. You can use “▼” or “▲” button to select a video file and press **OK** button to play a video. If you select a subtitle file and press **OK** button, you can select or deselect that subtitle file. The following menu will be displayed while playing a video file:

Jump (Numeric buttons): The TV will jump to the file starting with the letter you input via the numeric buttons on your remote control.

Play This (OK button): Plays the selected file.

Play (▶ button): Plays all media files starting with the selected one.

Lang (Play Preview): Displays selected file in a small preview screen.

RED button: Sorts files by date.

YELLOW button: Toggles viewing style.

BLUE button: Changes filter options.

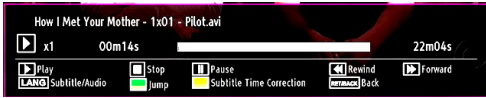

Play (▶ button): Starts the video playback.

Stop (■ button): Stops the video playback.

Pause (⏸ button): Pause the video playback.

Rewind (◀ button): Goes backward.

Forward (▶▶ button): Goes forward.

Subtitle/Audio (LANG. button): Sets subtitle/Audio.

Yellow: Opens subtitle time correction menu.

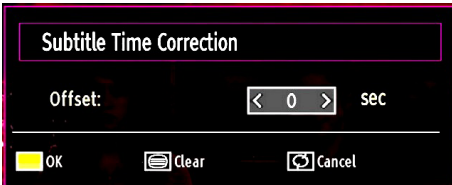

Press **BACK** button to switch back to previous menu.

Viewing Photos via USB

When you select Photos from the main options, available image files will be filtered and listed on this screen.

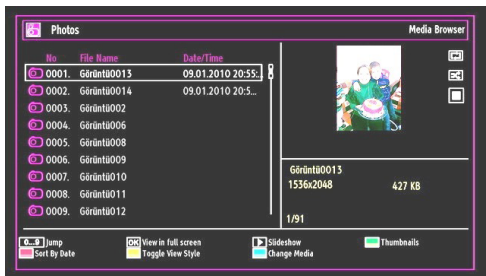

Jump (Numeric buttons): Jump to selected file using the numeric buttons.

OK: Views the selected picture in full screen.

Slideshow (▶ button): Starts the slideshow using all images.

GREEN button: Views images in thumbnails.

RED button: Sorts files by date.

YELLOW button: Toggles viewing style.

BLUE button: Changes media type.

Slideshow Options

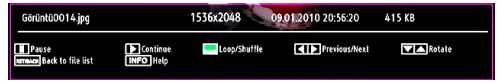

Pause (⏸ button) : Pauses the slideshow.

Continue (▶ button) : Continues the slideshow.

Loop/Shuffle (GREEN button): Press once to disable Loop. Press again to disable both Loop and Shuffle. Press once more to enable only Shuffle. Press again to enable all. You can follow the disabled functions with the change of the icons.

Previous/Next (Left/Right buttons): Jumps to previous or next file on slideshow.

Rotate (Up/Down buttons): Rotates the image using up/down buttons.

RETURN (Exit): Back to file list.

INFO: Displays help screen.

Viewing Music via USB

When you select Music from the main options, available audio files will be filtered and listed on this screen.



Play (▶ button) : Plays all media files starting with the selected one.

Stop (■ button) : Stops playback.

Pause (⏸ button) : Pauses the selected playback.

RED: Sorts files by Title, Artist or Album.

Loop/Shuffle (GREEN button): Press once to disable Loop. Press again to disable both Loop and Shuffle. Press once more to enable only Shuffle. Press again to enable all. You can follow the disabled functions with the change of the icons.

0..9 (Numeric buttons): Jumps to the selected file.

Play This (OK button) : Plays the selected file.

Previous/Next (Left/Right buttons) : Jumps to previous or next file to play.

YELLOW: Toggles viewing style.

BLUE: Changes media type.

Media Browser Settings

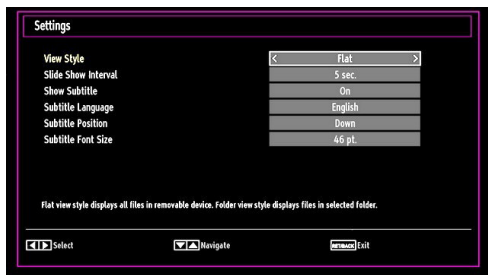

You can set your Media Browser preferences by using the Settings dialog. Press “▼” or “▲” button to highlight an item and use “◀” or “▶” button to set.

View Style: Sets default browsing mode.

Slide Show Interval: Sets slide show interval time.

Show Subtitle: Sets subtitle enabling preference.

Subtitle Language: Sets supported subtitle language.

Subtitle Position: Sets subtitle position as up or down.

Subtitle Font Size: Sets subtitle font size (max. 54pt).

Changing Image Size: Picture Formats

- You can change the aspect ratio (image size) of the TV for viewing the picture in different zoom modes.

- Press the “” button repeatedly to change the image size. Available zoom modes are listed below.

Auto

When AUTO is selected, the aspect ratio of the screen is adjusted by the information provided by the selected source(if available)

Note: Auto mode only will be available in HDMI, YPbPr and DTV sources.

16:9

This uniformly stretches the left and right sides of a normal picture (4:3 aspect ratio) to fill the wide TV screen.

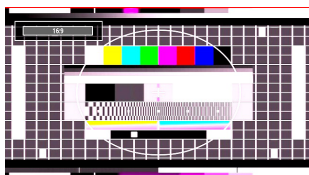

- For 16:9 aspect ratio pictures that have been squeezed into a normal picture (4:3 aspect ratio), use the **16:9** mode to restore the picture to its original shape.

Subtitle

This zooms up the wide picture (16:9 aspect ratio) with subtitles to the full screen.

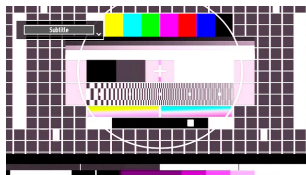

Note: You can shift to screen up or down by pressing “▼” / “▲” buttons while picture zoom is selected as, 14:9 Zoom, Cinema or Subtitle.

14:9

This zooms up the wide picture (14:9 aspect ratio) to the upper and lower limits of the screen.

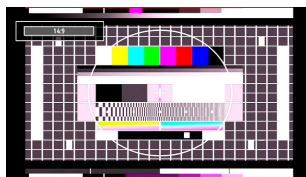

14:9 Zoom

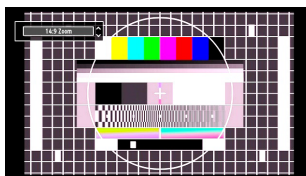

This option zooms to the 14:9 picture.

4:3

Use to view a normal picture (4:3 aspect ratio) as this is its original size.

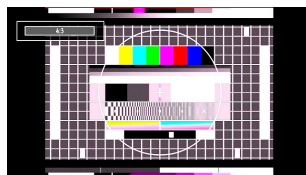

Cinema

This zooms up the wide picture (16:9 aspect ratio) to the full screen.

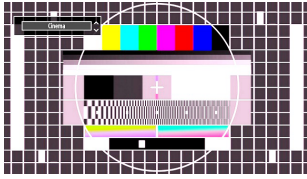

Configuring Picture Settings

You can use different picture settings in detail.

Press “**MENU**” button and select the Picture icon by using “**◀**” or “**▶**” button. Press **OK** button to view Picture Settings menu.

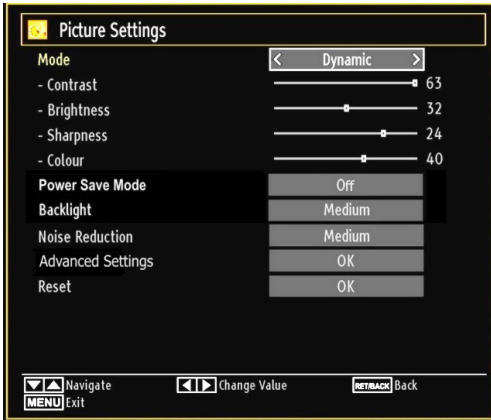

Operating Picture Settings Menu Items

- Press “**▼**” or “**▲**” button to highlight a menu item.
- Use “**◀**” or “**▶**” button to set an item.
- Press “**MENU**” button to exit.

Picture Settings Menu Items

Mode: For your viewing requirements, you can set various screen modes. The Picture mode can be set to one of these options: **Cinema**, **Game**, **Dynamic** and **Natural**.

Contrast: Sets the lightness and darkness values of the screen.

Brightness: Sets the brightness value for the screen.

Sharpness: Sets the sharpness value for the objects displayed on the screen.

Colour: Sets the colour value, adjusting the colors.

Power Save Mode: Use “**▼**” or “**▲**” button to select Power Save Mode.

Press “**◀**” or “**▶**” button to set Power Save Mode as On or Off.

See the section, “Environmental Information” in this manual for further information on Power Save Mode.

Note : The backlight function will be inactive if Power Save Mode is set to on.

Backlight (optional): This setting controls the backlight level and it can be set to Auto, Maximum, Minimum, Medium and Eco Mode.

Note: Backlight can not be activate in VGA or Media Browser mode or while picture mode is set as Game.

Noise Reduction: If the broadcast signal is weak and the picture is noisy, use **Noise Reduction** setting to reduce the noise amount. Noise Reduction can be set to one of these options: **Low**, **Medium**, **High** or **Off**.

Advanced Settings

- **Colour Temp:** Sets the desired colour tone.

Setting **Cool** option gives white colours a slight blue stress.

For normal colours, select **Normal** option.

Setting **Warm** option gives white colours a slight red stress.

- **Picture Zoom:** Sets the picture size to **Auto**, **16:9**, **Subtitle**, **14:9**, **14:9 Zoom**, **4:3** or **Cinema**.

- **HDMI True Black (optional):** While watching from HDMI source, this feature will be visible in the Picture Settings menu. You can use this feature to enhance blackness in the picture. You can set this feature as “On” for activating HDMI True Black mode.

- **Film Mode (optional):** Films are recorded at a different number of frames per second to normal television programmes. Press “**▼**” or “**▲**” buttons to select Film mode. Press “**◀**” or “**▶**” buttons to set this feature Auto or Off. Turn this feature to Auto when you are watching films to see the fast motion scenes clearly.

- **Colour Shift:** Adjust the desired colour tone.

Reset: Resets the picture settings to factory default settings.

While in VGA (PC) mode, some items in Picture menu will be unavailable. Instead, VGA mode settings will be added to the Picture Settings while in PC mode.

PC Picture Settings

For adjusting PC picture items, do the following:

Press “**◀**” or “**▶**” button to select Picture icon. Picture menu appears on the screen.

Contrast, **Brightness**, **Colour**, **Colour Temp** and **Picture Zoom** settings in this menu are identical to settings defined in TV picture menu under “Main Menu System”.

Sound, Settings and Source settings are identical to the settings explained in main menu system.

PC Position: Select this to display PC position menu items.

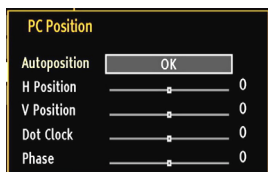

Autoposition: Automatically optimizes the display. Press **OK** to optimize.

H Position: This item shifts the image horizontally to right hand side or left hand side of the screen.

V Position: This item shifts the image vertically towards the top or bottom of the screen.

Dot Clock: Dot Clock adjustments correct the interference that appear as vertical banding in dot intensive presentations like spreadsheets or paragraphs or text in smaller fonts.

Phase: Depending on the resolution and scan frequency that you input to the TV set, you may see a hazy or noisy picture on the screen. In such a case you can use this item to get a clear picture by trial and error.

Configuring Sound Settings

Sound settings can be configured according to your personal preferences.

Press **"MENU"** button and select the Sound icon by using **"◀"** or **"▶"** button. Press **OK** button to view Sound Settings menu.

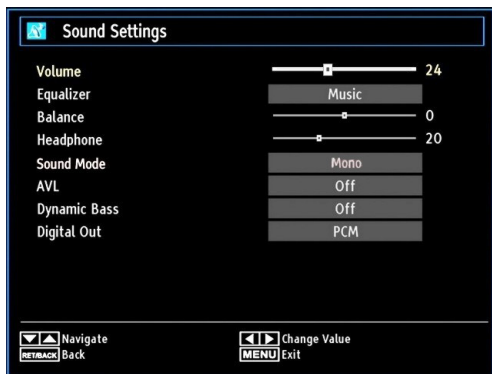

Operating Sound Settings Menu Items

- Press **"▼"** or **"▲"** button to highlight a menu item.
- Use **"◀"** or **"▶"** button to set an item.
- Press **"MENU"** button to exit.

Sound Settings Menu Items

Volume: Adjusts volume level.

Equalizer: Press **OK** button to view equalizer sub-menu.

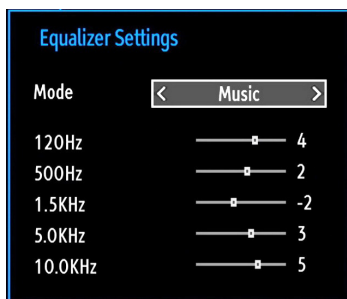

In the equalizer menu, the preset can be changed to **Music**, **Movie**, **Speech**, **Flat**, **Classic** and **User**. Press the **"MENU"** button to return to the previous menu.

Note: Equalizer menu settings can be changed manually only when the **Equalizer Mode** is in **User**.

Balance: This setting is used for emphasizing left or right speaker balance.

Headphone: Sets headphone volume.

Sound Mode: You can select Mono, Stereo, Dual I or Dual II mode, only if the selected channel supports that mode.

AVL: Automatic Volume Limiting (AVL) function sets the sound to obtain fixed output level between programmes (For instance, volume level of advertisements tend to be louder than programmes).

Dynamic Bass: Dynamic Bass is used to increase bass effect of the TV set.

Digital Out: Sets digital out audio type.

Configuring Your TV's Settings

Detailed settings can be configured to suit your personal preferences.

Press **"MENU"** button and select Settings icon by using **"◀"** or **"▶"** button. Press **OK** button to view Settings menu.



Operating Settings Menu Items

- Press “▼” or “▲” button to highlight a menu item.
- Press **OK** button to select an item.
- Press “**MENU**” button to exit.

Settings Menu Items

Conditional Access: Controls conditional access modules when available.

Language: Configures language settings.

Parental: Configures parental settings.

Timers: Sets timers for selected programmes.

Date/Time: Sets date and time.

Sources: Enables or disables selected source options.

Other Settings: Displays other setting options of the TV set.

Using a Conditional Access Module (not included)

IMPORTANT: Insert or remove the CI module only when the TV is SWITCHED OFF.

- In order to watch certain digital channels, a conditional access module (CAM) may be necessary. This module must be inserted in the CI slot of your TV.
- Obtain the Conditional Access Module (CAM) and the viewing card by subscribing to a pay channel company, then insert those to the TV using the following procedure.
- Insert the CAM and then the viewing card to the slot that is located in the terminal cover at the rear side of the TV.
- The CAM should be correctly inserted, it is impossible to insert fully if reversed. The CAM or the TV terminal may be damaged if the CAM is forcefully inserted.

Connect the TV to the mains supply, switch on and then wait for few moments until the card is activated.

- When no module is inserted, “**No Common Interface module detected**” message appears on the screen.
- Refer to the module instruction manual for details of the settings.

Viewing Conditional Access Menu (*)

() These menu settings may change depending on the service provider.*

Press “**MENU**” button and select the icon by using “◀” or “▶” button. Press **OK** button to view Settings menu. Use “▼” or “▲” button to highlight **Conditional Access** and press **OK** to view menu items.

Configuring Language Preferences

You can operate the TV's language settings using this menu.

Press “**MENU**” button and select the Settings icon by using “◀” or “▶” button. Press **OK** button to view Settings menu. Use “▼” or “▲” button to highlight **Language** and press **OK** to continue:

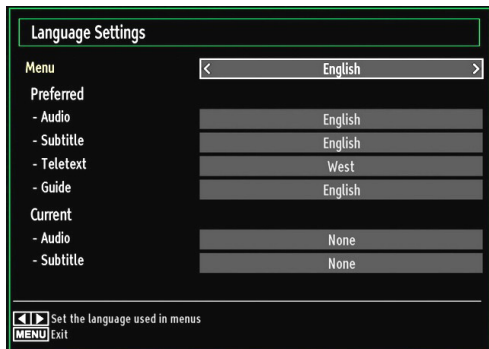

Use “▼” or “▲” button to set an item. Settings are stored automatically.

Menu: displays the system language.

Preferred

These settings will be used if available. Otherwise the current settings will be used.

- **Audio:** Sets the preferred audio language.
- **Subtitle:** Sets the subtitle language. Selected language will be seen in subtitles.
- **Teletext:** Sets teletext language.
- **Guide:** Sets the preferred Guide language.

Current (*)

(*) These settings can be changed if only the broadcaster supports. Otherwise, settings will not be available to be changed.

- **Audio:** Changes the audio language for the current channel.
- **Subtitle:** Sets the subtitle language for the current channel.

Note: If the Country option is set to Denmark, Sweden, Norway or Finland, the Language Settings menu will function as described below:

Language Settings

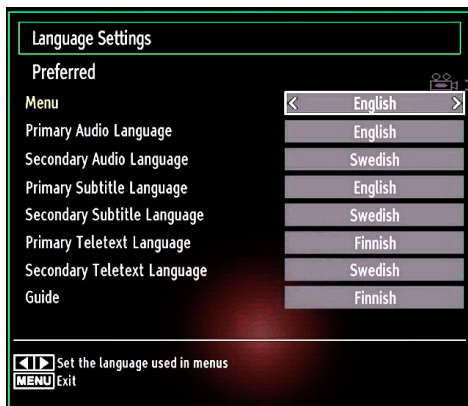

In the configuration menu, highlight the Language Settings item by pressing “▼” or “▲” buttons. Press **OK** and Language Settings submenu will be displayed on the screen:

Use “▼” or “▲” buttons to highlight the menu item that will be adjusted and then press “◀” or “▶” button to set.

Notes:

- System Language determines the on-screen menu language.
- Audio Language is used for selecting the soundtrack of a channels.
- Primary settings are the first priority when multiple choices are available on a broadcast. Secondary settings are the alternatives when the first options are not available.

Parental Control

To prohibit viewing of certain programmes, channels and menus can be locked by using the parental control system.

This function enables or disables the menu protection system and allows the PIN code to be changed.

Press “**MENU**” button and select the Settings icon by using “◀” or “▶” button. Press **OK** button to view Settings menu. Use “▼” or “▲” button to highlight **Parental** and press **OK** to continue:



To display parental lock menu options, the PIN number should be entered. The factory default PIN number is **0000**.

After coding the correct PIN number, parental settings menu will be displayed:



Parental Settings Menu Operation

- Select an item by using “▼” or “▲” button.
- Use “◀” or “▶” button to set an item.
- Press **OK** button to view more options.

Menu Lock (optional): Menu lock setting enables or disables the menu access. You can disable access to the installation menu or the whole menu system.

Maturity Lock (optional): When set, this option gets the maturity information from the broadcast and if this maturity level is disabled, disables access to the broadcast.

Child Lock (optional): When Child Lock is set, the TV can only be controlled by the remote control. In this case the control panel buttons will not work. Hence, if one of those buttons is pressed, **Child Lock Is On** will be displayed on the screen when the menu screen is not visible.

Set PIN: Defines a new PIN number. Use numeric buttons to enter a new pin number. You will need to enter your new pin a second time for verification purposes.

IMPORTANT: The factory default pin number is **0000**, if you change the pin number make sure you write it down and keep it safe.

Timers

To view Timers menu, press “**MENU**” button and select Settings icon by using “◀” or “▶” button. Press **OK** button to view Settings menu. Use “▼” or “▲” button to highlight Timers and press **OK** to continue:

Setting Sleep Timer

This setting is used for setting the TV to turn off after a certain time.

- Highlight Sleep Timer by using “▼” or “▲” button.
- Use “◀” or “▶” button to set. The timer can be programmed between **Off** and **2.00** hours (120 minutes) in steps of 30 minutes.

Setting Programme Timers

You can set programme timers for a particular programme using this feature.

Press “▼” button to set timers on an event. Programme timer function buttons will be displayed on the screen.

Adding a Timer

- Press **YELLOW** button on the remote control to add a timer. The following menu appears on the screen:

Channel: Changes network type by using “◀” or “▶”.

Timer Type: This feature is unavailable to be set.

Date: Enter a date using the numeric buttons.

Start: Enter a starting time using the numeric buttons.

End: Enter an ending time using the numeric buttons.

Duration: Displays duration between the starting and ending time.

Repeat: Sets a timer to be repeated as Once, Daily or Weekly. Use “◀” or “▶” buttons to select an option.

- Press **GREEN** button to save the timer. Press **RED** button to cancel.

Change/Delete: Controls parental settings on timers.

Editing a Timer

- Select the timer you want to edit by pressing “▼” or “▲” button.
- Press **GREEN** button. Edit Timer menu screen will be displayed.
- When finished with editing, press **GREEN** button to save. You can press “**MENU**” button to cancel.

Deleting a Timer

- Select the timer you want to delete by pressing “▼” or “▲” button.
- Press **RED** button.
- Select **YES** by using “◀” or “▶” buttons to delete the timer. Select **NO** to cancel.

Configuring Date/Time Settings

Select **Date/Time** in the Settings menu to configure Date/Time settings. Press **OK** button.

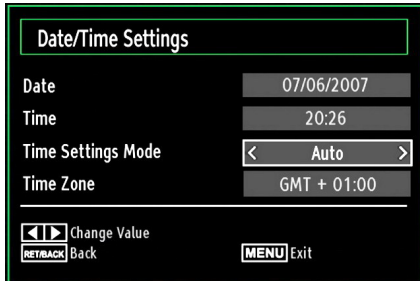

- Use “▼” or “▲” buttons to highlight **Date/Time**.

Date, Time, Time Settings Mode and Time Zone Setting will be available.

Use “▼” or “▲” buttons to highlight the Time Settings Mode. Time Settings Mode is set using “◀” or “▶” buttons. It can be set to AUTO or MANUAL.

When AUTO is selected, Date/Time and Time Zone options will not be available to be set. If MANUAL option is selected as the Time Zone can be altered:

- By pressing “▼” or “▲” buttons select Time Zone.

Use “◀” or “▶” buttons to change the Time Zone between GMT-12 or GMT+12. Date/Time on the top of the menu list will then change according to the selected Time Zone.

- Changes are automatically stored. Press “**MENU**” to exit.

Configuring Source Settings

You can enable or disable selected source options. The TV will not switch to the disabled source options when

“” button is pressed.

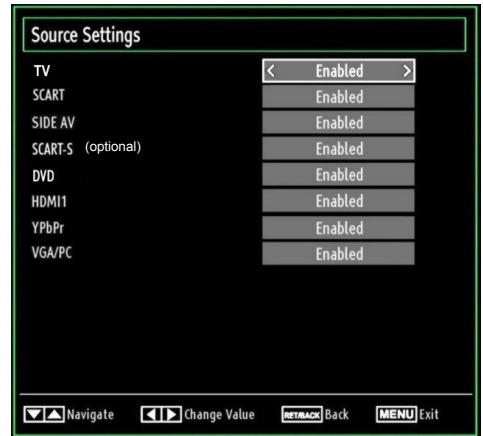

- Select **Sources** in the Settings menu and press **OK** button.

- Press “▼” or “▲” buttons to select a source.

- Use “◀” or “▶” button to enable or disable the selected source. Changes are automatically stored.

Note: YPbPr mode can be used only when you connect a device that has a YPbPr output through the PC input with YPbPr to PC cable (not supplied).

Configuring Other Settings

To view general configuration preferences, select **Other Settings** in the Settings menu and press **OK** button.

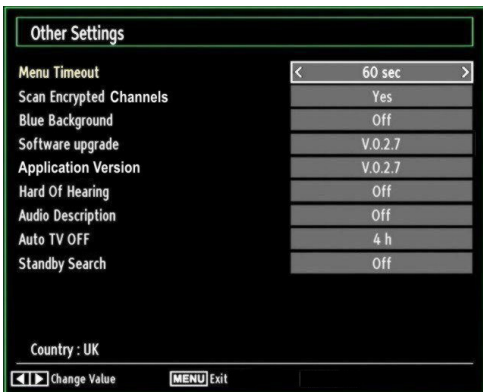

Operation

- Press “▼” or “▲” buttons to select an item.
- Use “◀” or “▶” button to set an option.
- Press **OK** button to view a sub-menu.

Menu Timeout: Changes timeout duration for menu screens.

Scan Encrypted Channels: When this setting is on, search process will locate the encrypted channels as well. If it is set as **Off**, encrypted channels will not be located in automatic search or manual search.

Blue Background (Optional): Activates or deactivates blue background system when the signal is weak or absent.

Software Upgrade: To ensure that your TV always has the most update information, you can use this setting. In order for the proper operation, please ensure that the TV is set to standby mode.

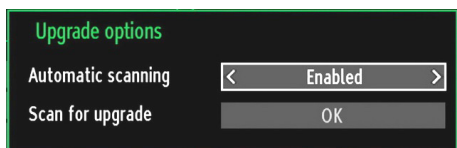

You can enable or disable automatic upgrade by setting **Automatic Scanning** option.

You can manually search for new software by selecting **Scan for upgrade**.

Application version: Displays the current application version.

Hard of Hearing: If the broadcaster enables any special signal concerning the audio, you can set this setting as On to receive such signals.

Audio Description: Audio description refers to an additional narration track for blind and visually impaired viewers of visual media, including television and movies. The description narrator talks through the presentation, describing what is happening on the screen during the natural pauses in the audio (and sometimes during dialogue, if deemed necessary). You can use this feature, only if the broadcaster supports that additional narration track.

Auto TV Off: You can set the timeout value of auto off feature. After the timeout value is reached and the TV is not operated for selected time, the TV will go off.



Standby Search (optional): Use “▼” or “▲” button to select Standby Search and then press “◀” or “▶” button to set this setting as On or Off. If you change Standby Search to Off, this function will be unavailable. To use Standby search please make sure that you select Standby Search as On.

Other Features

Displaying TV Information: Programme Number, Programme Name, Sound Indicator, time, teletext, channel type and resolution information is displayed on the screen when a new programme is entered or “**INFO**” button is pressed.

Mute Function: Press “~~X~~” button to disable sound. Mute indicator will be displayed in the upper side of the screen. To cancel mute, there are two alternatives; the first one is pressing the “~~X~~” button and the second one is increasing the volume level.

Picture Mode Selection: By pressing **PRESETS** button, you can change **Picture Mode** settings in accordance with your viewing requirements. Available options are Dynamic, Natural, Cinema and Game.

Displaying Subtitles: You can enable subtitles by pressing the  button of the remote control. Press  button again to disable subtitle function.

If “Subtitle” is On, pressing the  button causes the following warning message display on the screen (** for UK only).

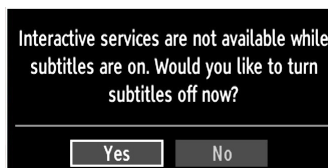



Teletext

The teletext system transmits information such as news, sports and weather on your TV. Note that if the signal degrades, for example in poor/adverse weather conditions, some text errors may occur or the teletext mode may be aborted.



Teletext function buttons are listed below:

“” **Teletext / Mix:** Activates teletext mode when pressed once. Press again to place the teletext screen over the programme (mix). Pressing again will quit the teletext mode.

“” **Index:** Selects the teletext index page.

“” **Reveal:** Shows hidden information (e.g. solutions of games).



“**OK**” **Hold:** Holds a text page when convenient. Press again to resume.

“”/“” **Subcode Pages:** Selects subcode pages if available when the teletext is activated.

P+ or P- and numbers (0-9): Press to select a page.

Note: Most TV stations use code 100 for their index pages.

Coloured Buttons (RED/GREEN/YELLOW/BLUE)

Your TV supports both **FASTTEXT** and **TOP text** systems. When these systems are available, the pages are divided into groups or topics. When **FASTTEXT** system is available, sections in a teletext page will become colour-coded and can be selected by pressing the coloured buttons. Press a coloured button that corresponds to with your needs. The coloured writings will appear, showing you which coloured buttons to use when **TOP text** transmission is present. Pressing “” or “” commands will request the next or previous page respectively.

Tips

Screen Care: Clean the screen with a slightly damp, soft cloth. Do not use abrasive solvents as they may damage the coating layer of the TV screen. For your safety, unplug the mains plug when cleaning the set. When moving the TV, hold it properly from the bottom of the unit.

Image Persistence: Please note that ghosting may occur while displaying a persistent image. On LED TVs' image persistence may disappear after a short time. Try turning the TV off for a while.

To avoid this, do not leave the screen in still picture for extended periods.

No Power: If your TV system has no power, please check the main power cable and connection to the mains socket outlet.

Poor Picture: Have you selected the correct TV system? Is your TV set or house aerial located too close to a non-earthed audio equipment or neon lights, etc.? Mountains or high buildings can cause double pictures or ghost images. Sometimes you can improve the picture quality by changing the direction of the aerial. Is the picture or teletext unrecognisable? Check if you have entered the correct frequency. Please retune the channels. The picture quality may degrade when two peripherals are connected to the TV at the same time. In such a case, disconnect one of the peripherals.

No Picture: Is the aerial connected properly? Are the plugs connected tightly to the aerial socket? Is the aerial cable damaged? Are suitable plugs used to connect the aerial? If you are in doubt, consult your dealer. No Picture means that your TV is not receiving a transmission. Have you selected the correct button on the remote control? Try once more. Also make sure the correct input source has been selected.

Sound: If you cannot hear any sound, check to see if the “” button has been pressed. If sound is coming from only one speaker, check if the audio balance has been set to one extreme.

Remote Control: Your TV no longer responds to the remote control. Perhaps the batteries are exhausted. If so you can still use the local buttons on the TV.

Input Sources: If you cannot select an input source, it is possible that no device is connected. Check the AV cables and connections if you have tried to connect a device.

Appendix A: PC Input Typical Display Modes

The display has a maximum resolution of 1920 x 1200. The following table is an illustration of some of the typical video display modes. Your TV may not support different resolutions. Supported resolution modes are listed below. If you switch your PC to an unsupported mode, a warning OSD will appear on the screen.

Index	Resolution	Frequency
1	640x350	85 Hz
2	640x400	70 Hz
3	640x480	60Hz-66Hz-72Hz -75Hz-85Hz
4	800x600	56Hz-60Hz-70Hz-72Hz -75Hz-85Hz
5	832x624	75 Hz
6	1024x768	60Hz-66Hz-70Hz-72Hz -75Hz
7	1152x864	60Hz-70Hz-75Hz -85 Hz
8	1280x768	60 HzA
9	1280x768	60 HzB
10	1280x768	75Hz-85Hz
11	1280x960	60Hz-75Hz-85Hz
12	1280x1024	60Hz-75Hz-85Hz
13	1360x768	60 Hz
14	1400x1050	60 HzA
15	1400x1050	60 HzB
16	1400x1050	75Hz-85Hz
17	1400x900	65Hz-75Hz
18	1600x1200	60 Hz
19	1680x1050	60 Hz
20	1920x1080	60 HzA
21	1920x1080	60 HzB
22	1920x1200	60HzA
23	1920x1200	60Hz

Appendix B: AV and HDMI Signal Compatibility (Input Signal Types)

Source	Supported Signals		Available
EXT (SCART)	PAL 50/60		O
	NTSC 60		O
	RGB 50		O
	RGB 60		O
Side AV	PAL 50/60		O
	NTSC 60		O
YPbPr	480I	60Hz	O
	480P	60Hz	O
	576I	50Hz	O
	576P	50Hz	O
	720P	50Hz	O
	720P	60Hz	O
	1080I	50Hz	O
	1080I	60Hz	O
	1080P	50Hz	O
	1080P	60Hz	O
HDMI1	480I	60Hz	O
	480P	60Hz	O
	576I	50Hz	O
	576P	50Hz	O
	720P	50Hz	O
	720P	60Hz	O
	1080I	50Hz	O
	1080I	60Hz	O
	1080P	24Hz	O
	1080P	25Hz	O
	1080P	30Hz	O
	1080P	50Hz	O
	1080P	60Hz	O

(X: Not Available, O: Available)

In some cases a signal on the LED TV may not be displayed properly. The problem may be an inconsistency with standards from the source equipment (DVD, Set-top box, etc.). If you do experience such a problem please contact your dealer and also the manufacturer of the source equipment.

Appendix C: Supported DVI Resolutions

When connecting devices to your TV's connectors by using DVI to HDMI cables (not supplied), you can refer to the following resolution information.

Index	Resolution	Frequency
1	640x400	70Hz
2	640x480	60Hz-66Hz-72Hz-75Hz
3	800x600	56Hz-60Hz-70Hz-72Hz-75Hz
4	832x624	75 Hz
5	1024x768	60Hz-66Hz-70Hz-72Hz-75Hz
6	1152x864	60Hz-70Hz-75Hz
7	1152x870	75Hz
8	1280x768	60 Hz
9	1280x768	75Hz
10	1280x960	60Hz-75Hz
11	1280x1024	60Hz-75Hz
12	1360x768	60 Hz
13	1400x1050	60 Hz
14	1400x1050	75Hz
15	1400x900	65Hz-75Hz
16	1600x1200	60 Hz
17	1680x1050	60 Hz
18	1920x1080	60 Hz
19	480i-480p	60Hz
20	576i-576p	50Hz

Appendix D: Software Upgrade

- Your TV is capable of finding and updating new software upgrades over broadcast channels.
- For broadcast channels search, the TV looks at the available channels stored in your settings. So before the software upgrade search, it is advised to auto search and update all available channels.

1) Software upgrade search via user interface

- It is possible to manually to check if there is a new software upgrade for your TV set.
- Simply navigate on your main menu. Choose Settings and select Other Settings menu. In Other Settings menu navigate on to the Software Upgrade item and press **OK** button to open Upgrade Options menu.
- In Upgrade Options menu select Scan for upgrade and press **OK** button.
- If a new upgrade is found, it starts to download the upgrade. A progress bar indicates the remaining download progress. When the download completes successfully a message is displayed for reboot to activate new software. Press **OK** to continue with the reboot operation.

2) 3.AM search and upgrade mode

- If Automatic scanning in Upgrade Options menu is enabled, the TV wakes up at 03:00 and searches the broadcast channels for new software upgrade. If new software is found and downloaded successfully, with the next power up the TV opens with new software version.

Note on reboot operation: Reboot is the last step in software upgrade operation if download of new software is finished successfully. During reboot TV makes final initializations. In the reboot sequence panel power is closed and front led indicates the activity with blinking. Around 5 minutes later TV restarts with new software activated.

- If your TV fails to restart in 10 minutes, unplug power for 10 minutes and re-plug again. TV should open with new software safely. If you still can not get TV working, please kindly repeat unplug and plug sequence a few times more. If your set still can not operate, please call the service personnel to fix the problem for you.

Caution: While the LED is blinking during reboot do not unplug your TV's power. Doing this may cause your TV not to re-start again and can only be fixed by service personnel.

Appendix E : Supported File Formats for USB Mode

Media	File Extension	Format		Remarks
		Video	Audio	(Maximum resolution/Bit rate etc.)
Movie	.mpg, .mpeg	MPEG1, 2	MPEG Layer 1/2/3	MAX 1920x1080 @ 30P 20Mbit/sec
	.dat	MPEG1, 2	MPEG2	
	.vob	MPEG2		
	.avi	MPEG2	PCM/MP3	MAX 1920x1080 @ 30P 20Mbit/sec
Xvid 1.00, Xvid 1.01, Xvid 1.02, Xvid 1.03, Xvid 1.10-beta1/2		PCM		
Music	.mp3	-	MPEG 1 Layer 1 / 2 (MP3)	32Kbps ~ 320Kbps(Bit rate) 32KHz ~ 48KHz(Sampling rate)
Photo	.jpg .jpeg	Baseline JPEG		max WxH = 15360x8640 4147200bytes
		Progressive JPEG		max WxH = 1024x768 6291456bytes
	.bmp	-		max WxH = 9600x6400 3840000bytes
Subtitle	.sub	-		-
	.srt	-		



Products



Battery

Information for Users on Disposal of old Equipment and Batteries

[European Union only]

These symbols indicate that equipment with these symbols should not be disposed of as general household waste. If you want to dispose of the product or battery, please consider the collection systems or facilities for appropriate recycling.

Notice: The sign Pb below the symbol for batteries indicates that this battery contains lead.

Specifications

TV BROADCASTING

PAL/SECAM B/G D/K K' I/I' L/L'

RECEIVING CHANNELS

VHF (BAND I/III)

UHF (BAND U)

HYPERBAND

NUMBER OF PRESET CHANNELS

1000

CHANNEL INDICATOR

On Screen Display

RF AERIAL INPUT

75 Ohm (unbalanced)

OPERATING VOLTAGE

110-240V AC, 50/60 Hz.

AUDIO

German + Nicam Stereo

AUDIO OUTPUT POWER ($W_{RMS.}$) (10% THD)

2 x 2,5

POWER CONSUMPTION (W)

47 W (max)

PANEL

19" Screen Size

DIMENSIONS (mm)

DxLxH (With foot): 134 x 451 x 331



Weight (Kg): 3,60

DxLxH (Without foot): 54 x 451 x 296



Weight (Kg): 3,40

Digital Reception DVB-T	MHEG-5 ENGINE compliant with ISO/IEC 13522-5 UK engine Profile 1	for UK
	Object carousel support compliant with ISO/IEC 135818-6 and UK DTT profile	
	Frequency range: 474-850 MHz for UK models	
	170-862 MHz for EU models	
	Transmission standard: DVB-T. MPEG-2	
	Demodulation: COFDM with 2K/8K FFT mode	
	FEC: all DVB modes	
	Video: MP@ML, PAL, 4:3/16:9	
	Audio: MPEG Layer I&II 32/44.148kHz.	

Switching the TV On Using 12 Volt

1. Connect the cigarette lighter plug cable to the cigarette lighter socket of your car or a cable with clips to the battery of car, making sure to observe the correct polarity.
2. Plug the other side of 12 volt cable to DC 12 socket at the back of the TV. Then the standby LED lights up.
3. Press the “” button, **P+ / P-** or a numeric button on the remote control or press the “” button, - or + button on the TV. The TV will then switch on.
4. Adjust for best picture through antenna position or set TV channels again if necessary.

Switching the TV Off

1. Press the “” button on the remote control or press the “” switch on the TV, so the TV will switch to standby mode.
2. Unplug cable connectors and power plugs.



Contents

Features	75
General Properties.....	75
Safety Information	76
Notes on Discs	76
On handling discs	76
On cleaning.....	76
Licence Notification	76
How to Watch a DVD.....	76
DVD Control Panel Buttons	77
Overview of the Remote Control	77
General Operation	78
General Playback	79
Basic Play	79
For your reference:	79
Notes on Playback:.....	79
Setup Menu Items	79
Video Setup Page.....	79
TV Type.....	79
DivX VOD	79
Language Setup	79
OSD LANG	79
AUDIO	79
DISC MENU.....	79
SUBTITLE.....	79
Preferences	80
DEFAULT	80
DOWNMIX	80
PASSWORD (Change Password):	80
SPDIF OUTPUT.....	80
Troubleshooting	80
The picture quality is poor (DVD).....	80
Disc does not play	80
Wrong OSD language.....	80
Some functions (Angle, Zoom etc) do not work	81
No picture	81
No sound	81
Distorted sound.....	81
No response from remote control	81
If nothing works.....	81
Definition of Terms	81
Disc Types Compatible with This Unit	82
Supported File Formats	83
Specifications	83

Features

General Properties

- DVD / CD / CD-R / CD-RW / MP3 / JPEG / MPEG playback.
- NTSC/PAL playback (according to disc content)
- LPCM audio via coaxial digital audio output. (optional)
- Multi-Audio (up to 8) support (According to disc content)
- Multi-Subtitle (up to 32) support (According to disc content)
- Multi-Angle (up to 9) support (According to disc content)
- 8 level parental control
- Fast forward and rewind in 5 different speeds. (2x, 4x, 8x, 16x, 32x)
- Slow motion playback in 4 different speeds. (1/2x, 1/4x, 1/8x, 1/16x forward)
- Frame by frame forward playback.
- Search Mode
- Repeat
- Coaxial audio output (optional)
- Copied disks may be incompatible.

Note

- This DVD player may not support some MP3 recordings due to differences in recording formats or disc type.
- Please read the owner's manual about MP3 playback.
- CD-R/CD-RW discs recorded by CD-DA method can be played. Some CD-R/CD-RW discs may be incompatible due to laser pick-up and disc design.
- DVD-R/RW discs recorded by DVD-Video method can be played . Some DVD-R/RW discs may be incompatible due to laser pick-up and disc design.
- Some discs may be incompatible with JPEG Viewer function due to different recording format or condition of the discs.
- For proper operation, only 12 cm discs must be used.

Safety Information

CAUTION

DVD Player is a class 1 laser product. However this product uses a visible laser beam which could cause hazardous radiation exposure. Be sure to operate the player correctly as instructed.

**CLASS 1
LASER PRODUCT**

RISK OF ELECTRIC SHOCK

The lightning flash with arrowhead symbol, within an equilateral triangle, is intended to alert the user to the presence of uninsulated "dangerous voltage" within the product's enclosure that may be of sufficient magnitude to constitute a risk of electric shock of persons.



The exclamation point within an equilateral triangle is intended to alert the user to the presence of important operating and maintenance (servicing) instructions in the literature accompanying the appliance.



Notes on Discs

On handling discs

- To keep the disc clean, handle the disc by its edge. Do not touch the surface.
- Do not stick paper or tape on the disc.
- If the disc is contaminated with any substance like glue remove before using it.

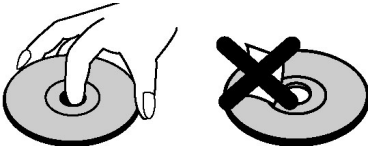

- Do not expose the disc to direct sunlight or heat sources such as hot air ducts, or leave it in a car parked in direct sunlight as the temperature can rise quickly and damage the disc.
- After playing, store the disc in its case.

On cleaning

- Before playing, clean the disc with a cleaning cloth. Wipe the disc from the center out.

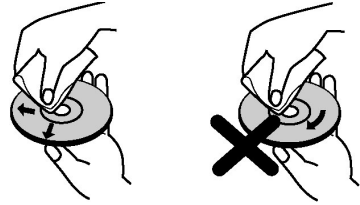

- Do not use solvents such as benzine, thinner, commercially available cleaners or anti-static spray intended for vinyl LPs.

Licence Notification

- This product incorporates copyright protection technology that is protected by U.S. patents and other intellectual property rights. Use of this copyright protection technology must be authorized by Rovi Corporation, and is intended for home and other limited viewing uses only unless otherwise authorized by Rovi Corporation. Reverse engineering and disassembly are prohibited.

How to Watch a DVD

When placing a disc into the loader, labeled side of the disc should be on the front:

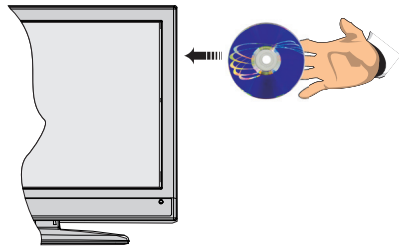

When TV set is turned on, first switch to DVD source by using the **SOURCE** button on the remote control. Press play on the remote control, or directly press play button at the front panel. If there is no disc inside the loader, place a DVD first and press play.

DVD Control Panel Buttons

A. Disc loader

B. Play / Pause

Plays/pauses the disc. When DVD menu (root menu) is active, this button functions as "button select" (selects the highlighted item in menu) if this is not prohibited by the disc.

C. Stop / Eject

Stop playing disc / Eject or Load the disc Note:

- You cannot eject the disc via the remote control.
- While playing a file, you should press STOP button three times to eject.

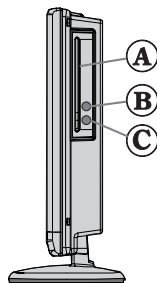

Overview of the Remote Control

- 1- Standby
- 2- Display time / dvd menu
- 3- No function
- 4- Numeric buttons
- 5- Menu button
- 6- Navigational buttons
- 7- Back / return
- 8- Volume up / down
- 9- Info
- 10- No function
- 11- Play
- 12- Language select
- 13- Rapid reverse
- 14- Red button / zoom
- 15- Green button / repeat
- 16- Search mode
- 17- Source select
- 18- No function
- 19- No function
- 20- OK button
- 21- Exit
- 22- Pause
- 23- Stop
- 24- Subtitle
- 25- Rapid advance
- 26- Blue button / title
- 27- Yellow button / root

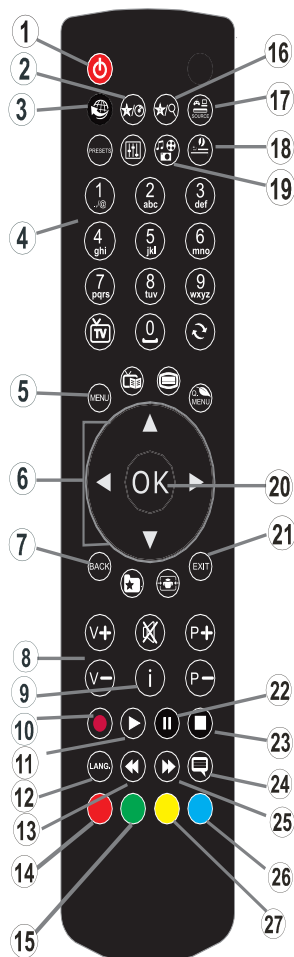

General Operation

You can operate DVD, movie CD, music or picture CD's content by using the proper buttons on your remote control. Below are main functions of commonly used remote control buttons.

Buttons on the Remote Control	DVD Playback	Movie Playback	Picture Playback	Music Playback
	Play	Play	Play	Play
	Pause	Pause	Pause	Pause
	Stop	Stop	Stop	Stop
	Shifts the zoomed picture left or right (if available).			
	Highlights a menu item. / Shifts the zoomed picture down or up (if available).			
	Fast reverse / Fast forward			
	Views the scene from different angles (if available).		Changes slide effect (depends on the content).	X
C	Clears digit (if available).			
My button 1	Displays time / Views main setup menu			
	Time counter mode selection (during playback). Press repeatedly to switch between modes.			
LANG.	Audio language.		X	X
MENU	Displays TV menu.			
OK / SELECT	Enter / View / Play			
REPEAT	Displays repeat options.			
RETURN	Returns back to the previous menu (if available).			
Yellow button	Goes back to the root folder (if available).			
my button 2	Direct selection of scenes or time.		Selects the desired file.	Selects the desired file.
	Subtitle on-off. Press repeatedly to switch between subtitle options.		X	X
Blue button	Displays disc menu (if available).	Displays disc menu (if available).	X	X
ZOOM	Zooms picture. Press repeatedly to switch between zoom options.			

Other Functions – Button Combinations (During playback)	
II + >>>	Slow forward.
[II + >>>] + <<<>>	Sets slow forward speed.
>>> + >>>	Sets fast forward speed.
<<< + <<<	Sets fast reverse speed.
■ + ■	Confirms stop command.
II + >>>	Press >>> repeatedly to advance manually.

(*) You can switch to title by pressing numeric keys directly. You need to press 0 and then digit key to switch one digit titles (example: to select 5, press 0 and 5).

General Playback

Basic Play

1. Press on the power button
2. Please insert a disc to the loader.

The disc will be automatically loaded and play commences if the disc does not have any menus recorded on it.

A menu may appear on the TV screen after a few moments or the film may start immediately after the introduction of the Film Company. This behaviour depends on the disc content and may change.

Note: Step 3 and 4 is available only when a menu is recorded on the disc.

3. Press "▼" / "▲" / ◀ / ▶ or the number button (s) to select the preferred title.
4. Press SELECT.

Play of the selected items now starts. The played item may be a motion picture, a still picture or another submenu depending on the disc.

For your reference:

If an action corresponding to a button is prohibited the "⊗" symbol appears.

Notes on Playback:

1. No sound will be heard during Rapid advance or Rapid reverse.
2. No sound will be heard during Slow motion play.
3. Reverse slow motion play is not available.
4. In some cases, the subtitle language is not changed immediately to the selected one.
5. When the preferred language is not selected even after pressing the button several times, it means that the language is not available on the disc.
6. When the player is restarted or the disc is changed, the subtitle selection is automatically changed back to the initial settings.
7. If a language is selected, not supported by the disc, the subtitle language will automatically be set to the disc's priority language.
8. Usually a circulation will happen while switching to another language, that is you can cancel the subtitle by pressing this button a number of times until "Subtitle Off" appears on the screen.
9. When the power is turned on or the disc is removed, the language heard is the one selected at the initial settings. If this language is not recorded on the disc, only the available language on the disc will be heard.
10. Some DVDs may not contain root and/or title menus.

11. Reverse stepping is not available.

12. For your convenience:

If you attempt to enter a number greater than the total time of the current title, the time search box disappears and "⊗ Input Invalid" message appears on up-left corner of screen.

13. Slide Show is disabled when the ZOOM mode is on.

Setup Menu Items

Video Setup Page

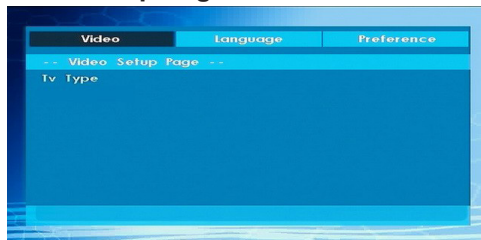

TV Type

TV Type is only available as 'PAL'. The TV set also supports NTSC signal; however, the signal will be converted to PAL when it appears on the screen.

Language Setup

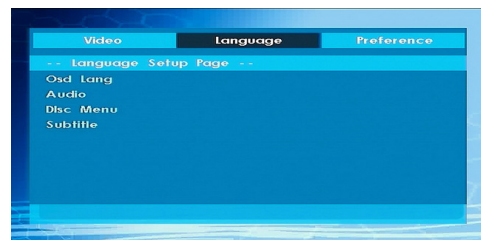

OSD LANG

You can select the default OSD language of the player menus

AUDIO

You can select the default audio language if supported by the DVD disc.

DISC MENU

You can select the DVD's disc menu language among these languages. Disc menu appears in the selected language, if supported by the DVD disc.

SUBTITLE

You can select the default subtitle language if supported by the DVD disc.

Preferences

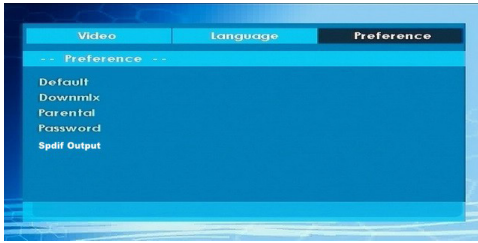

DEFAULT

If you choose RESET and press SELECT, the factory presets are loaded. Parental level and parental password does not change.

DOWNMIX

This mode can be selected when the digital audio output of the TV is used.

SURROUND: Surround sound output.

STEREO: Two channels stereo.

PARENTAL (Parental Level)

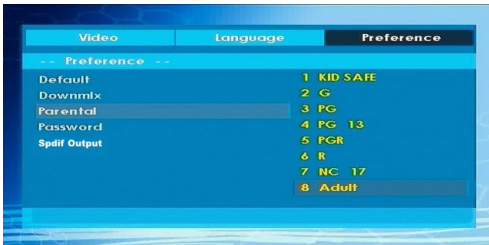

Playing some DVDs can be limited depending on the age of users. The "Parental Control" function allows playback limitation level to be set by the parent.

Parental Level can be adjusted to one of the eight levels. Level "8 ADULT" adjustment let you watch all of the DVD titles ignoring the DVD disc's parental level. You can watch the DVD discs, which has the same or lower parental level than the player's level only.

PASSWORD (Change Password):

Using this item you can change the current password.

To change the password you will be prompted to enter your old password. After you have entered your old password, you can now enter the new 4-digit password.

You can use C key to delete the incorrect entry.

Note: Factory preset of the password is "0000". You have to enter XXXX digital password every time you want to change the parental level. If you forget your password please contact technical service.

SPDIF OUTPUT

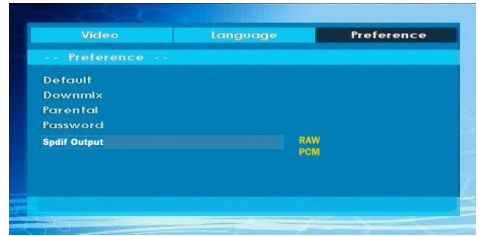

You can set Spdif Output as PCM or RAW. If you select PCM from SPDIF Output in DVD menu and play DVD with Dolby audio, you can get audio output with two channels via the speakers and the SPDIF Out. If you select RAW from SPDIF Output in DVD menu and play DVD with Dolby audio, speakers will be muted and you can get 5+1 Dolby audio via the SPDIF Out.

Troubleshooting

The picture quality is poor (DVD)

- Make sure the DVD disc surface is not damaged. (Scratch, fingerprint etc.)
- Clean the DVD disc and try again.

See instructions described in "Notes on Discs" to clean your disc properly.

- Ensure that the DVD disc is in the drawer with the label upmost.
- A damp DVD disc or condensation may effect the equipment. Wait for 1 to 2 hours in Stand-by to dry the equipment.

Disc does not play

- No disc in the machine.

Place a disc into the loader.

- Disc incorrectly loaded.

Ensure that the DVD disc is in the drawer with the label upmost.

- Wrong type of disc. The machine cannot play CD-ROMS etc.
- The region code of the DVD must match the player.

Wrong OSD language

- Select the language in the set-up menu.
- The language for the sound or subtitles on a DVD cannot be changed.
- Multilingual sound and/or subtitles not recorded on the DVD.
- Try to change the sound or subtitles using DVD's title menu. Some DVD's do not allow the user to change these settings without using the disc's menu

Some functions (Angle, Zoom etc) do not work

- These functions are not available on the DVD.
- Angle can only be changed when the angle symbol is displayed.

No picture

- Have you pressed the correct buttons on the remote control? Try once more.

No sound

- Check the volume is set to an audible level.
- Make sure you have not switched the sound off accidentally.

Distorted sound

- Check that the appropriate listening mode setting is correct.

No response from remote control

- Make sure the remote control is in the correct mode.
- Check batteries are fitted correctly.
- Change the batteries.

If nothing works

If you have tried the above solutions and none seem to work, try switching your TV-DVD off and on again. If this does not work, contact your supplier or TV-DVD repair technician. Never attempt to repair a defective TV-DVD yourself.

Definition of Terms

Angle

Recorded onto some DVD discs are scenes, which have been simultaneously shot from a number of different angles (the same scene is shot from the front, from the left side, from the right side, etc.). With such

discs, the  button can be used to view the scene from different angles.

Chapter Number

These numbers are recorded on DVD discs. A title is subdivided into many sections, each of which are numbered, and specific parts of video presentations can be searched quickly using these numbers.

DVD

This refers to a high-density optical disc on which high-quality pictures and sound have been recorded by means of digital signals. Incorporating a new video compression technology (MPEG II) and high-density recording technology. DVD enables aesthetically pleasing full-motion video to be recorded over long periods of time (for instance, a whole movie can be recorded).

DVD has a structure consisting of two 0.6-mm thin discs, which are adhered to each other. Since the thinner the disc, the higher the density at which the information can be recorded, a DVD disc has a greater capacity than a single 1.2 mm thick disc. Since the two thin discs are adhered to each other, there is the potential to achieve double-sided play sometime in the future for even longer duration play.

Subtitles

These are printed lines appearing at the bottom of the screen, which translate or transcribe the dialogue. They are recorded on the DVD discs.

Time Number

This indicates the playtime, which has elapsed from the start of a disc or a title. It can be used to find a specific scene quickly. (Not all discs permit the time search feature to be used. Availability is determined by the disc's manufacturer.)

Title Number

These numbers are recorded on DVD discs. When a disc contains two or more movies, these movies are numbered as title 1, title 2, etc.

Track Number

These numbers are assigned to the tracks, which are recorded on AudioCDs. They enable specific tracks to be located quickly.





LPCM

LPCM stands for Pulse Code Modulation and is digital audio.

MPEG

Short for Moving Picture Experts Group. This is an international standard for compression of moving images. On some DVDs digital audio has been compressed and recorded in this format.

Disc Types Compatible with This Unit

Disc Types (Logos)	Recording Types	Disc Size	Max. Playing Time	Characteristics
<p>DVD</p> 	<p>Audio + Video</p>	<p>12 cm</p>	<p>Single - sided; 240 min. Double - sided; 480 min.</p>	<ul style="list-style-type: none"> ● DVD contains excellent sound and video due to Dolby Digital and MPEG-2 System. ● Various screen and audio functions can be easily selected through the on screen menu.
<p>AUDIO-CD</p> 	<p>Audio</p>	<p>12 cm</p>	<p>74 min.</p>	<ul style="list-style-type: none"> ● An LP is recorded as an analog signal with more distortion. CD is recorded as a Digital Signal with better audio quality, less distortion and less deterioration of audio quality over time.
<p>MP3-CD</p> 	<p>Audio (xxxx.mp3)</p>	<p>12 cm</p>	<p>It depends on MP3 quality.</p>	<ul style="list-style-type: none"> ● MP3 is recorded as a Digital Signal with better audio quality, less distortion and less deterioration of audio quality over time.
<p>PICTURE-CD</p> 	<p>Video (still picture)</p>	<p>12 cm</p>	<p>It depends on JPEG quality.</p>	<ul style="list-style-type: none"> ● JPEG is recorded as a Digital Signal with better picture quality over time.

Supported File Formats

Media	File Extension	Format		Remarks
		Video	Audio	(Maximum resolution/Bit rate etc.)
Movie (optional)	.mpg/ .dat/ .vob	MPEG1	MPEG Layer 1/2/3	
		MPEG2	MPEG2	
	.avi	XviD/ 3ivx	PCM/MP3	XviD Version up to: 1.1.2
		MPEG4	PCM/MP3	
Music	-	-	PCM	Sample Rate: 8K ~ 48KHz
	.mp3	-	MPEG 1/2 Layer 1/2/3 (MP3)	Sample Rate: 8K ~ 48KHz, Bit Rate: 64K~320Kbps
Photo	.jpg	Baseline JPEG		WxH = 8902x8902 up to 77Mega-pixel Support format: 444/ 440/ 422/ 420/ Grayscale
		Progressive JPEG		Up to 4 Mega-pixel Support format: 444/ 440/ 422/ 420/ Grayscale
External Subtitles (optional)	.srt			Support Text File Format, but do not support Picture File Format
	.smi			
	.sub			
	.ssa			
	.ass			

Note: It is not guaranteed that all DivX formats are supported.

Specifications

Types of Discs Supported	DVD: SS/SL 4.7" (DVD-5) SS/DL 4.7" (DVD-9) DS/SL 4.7" (DVD-10) DS/DL 4.7" (DVD-18)	CD-DA CD-R CD-RW MP-3/JPEG
Video Type	MPEG-2 Video Standard Decoding (MPEG-1 supported) Full-Screen Video Display of 720 x 576 (PAL) & 720 x 480 (NTSC) pixels 50 and 60 Hz frame refresh rates (PAL & NTSC) Digital bit-stream processing rate up to 108Mbits/sec Line resolution more than 500 lines	
Audio Type	MPEG Multichannel Decoding LPCM	
Audio Output	Analog Outputs: 24 bit /48, 44.1kHz down-sampling DAC	