

# AKAI

## LED TV WITH DVB-T TUNER

AL2605TWE



Handleiding

User manual

Manuel de l'utilisateur

1

33

63

# Contents

Features .....	34	Managing Stations: Favourites .....	47
Introduction.....	34	Button Functions.....	47
Preparation.....	34	On-Screen Information .....	48
Safety Precautions .....	34	Viewing Photos via USB .....	49
Information for users in the EU.....	35	Media Browser Settings.....	50
Connection to a Television Distribution System (Cable TV etc.) from Tuner .....	35	Changing Image Size: Picture Formats.....	50
Environmental Information .....	37	Cinema .....	51
Repair Information .....	37	Configuring Picture Settings.....	51
Remote Control Buttons .....	38	Operating Picture Settings Menu Items.....	51
TV and Operating Control Switch.....	39	Picture Settings Menu Items.....	51
Viewing the Connections - Back Connectors .....	39	PC Picture Settings.....	51
Viewing the Connections - Side Connectors .....	40	Configuring Sound Settings.....	52
Aerial Connection .....	40	Operating Sound Settings Menu Items.....	52
Power Connection .....	40	Sound Settings Menu Items.....	52
USB Memory Connection .....	41	Configuring Your TV's Settings.....	53
Using Side AV Connectors .....	41	Operating Settings Menu Items .....	53
Connecting to a DVD Player.....	42	Settings Menu Items .....	53
Remote Control Handset.....	42	Viewing Conditional Access Menu (*).....	53
Inserting Batteries.....	42	Language Settings.....	54
To Switch the TV On.....	43	Parental Control.....	54
To Switch the TV Off.....	43	Parental Settings Menu Operation .....	55
Basic Operations .....	43	Timers.....	55
Operation with the Buttons on the TV.....	43	Setting Sleep Timer .....	55
Volume Setting.....	43	Setting Programme Timers .....	55
Programme Selection .....	43	Adding a Timer.....	55
Viewing Main Menu.....	43	Editing a Timer .....	55
AV Mode .....	43	Deleting a Timer.....	56
Operation with the Remote Control .....	43	Configuring Date/Time Settings.....	56
Volume Setting.....	44	Configuring Source Settings.....	56
Programme Selection (Previous or Next Programme).....	44	Operation .....	57
Programme Selection (Direct Access) .....	44	Other Features .....	57
Viewing Electronic Programme Guide (EPG).....	44	Appendix A: PC Input Typical Display Modes.....	59
First Time Installation.....	45	Appendix B: AV and HDMI Signal Compatibility (Input Signal Types).....	59
Installation .....	45	Appendix C: Supported DVI Resolutions.....	60
Auto Channel Scan (Retune) Menu Operation .....	46	1) Software upgrade search via user interface .....	60
Manual Tuning .....	46	2) 3.AM search and upgrade mode .....	60
Digital Manual Search.....	46	Appendix E : Supported File Formats for USB Mode.....	61
Analogue Manual Search .....	46	Specifications .....	62
Analogue Fine Tune.....	46		
Managing Stations: Channel List.....	46		
Operating the Channel List.....	47		
Moving a Channel.....	47		
Deleting a Channel .....	47		
Renaming a Channel.....	47		
Locking a Channel .....	47		

## Features

- Remote controlled colour LED TV.
- Fully integrated Terrestrial digital-cable TV (DVB-T MPEG2)
- HDMI connectors for digital video and audio.
- USB input.
- 1000 programmes (analogue+digital).
- On Screen Display (OSD) menu system.
- Integrated tuner DVB-T, MPEG2 compatible.
- Scart socket for external devices.
- Stereo sound system. (German+Nicam)
- Teletext, fastext, TOP text.
- Headphone connection.
- Automatic programming system.
- Forward or backward manual tuning.
- Sleep timer / Child lock.
- Automatic sound mute when no transmission.
- NTSC playback.
- AVL (Automatic Volume Limiting).
- Auto power down.
- PLL (Frequency Search).
- PC input.
- Plug&Play for Windows 98, ME, 2000, XP, Vista, Windows 7.
- Game Mode.

## Introduction

Thank you for choosing this product. This manual will guide you through the proper operation of your TV. Before operating the TV, please read this manual thoroughly. Please keep this manual in a safe place for future reference.

This device is intended to receive and display TV programmes. The different connection options make an additional expansion of the reception and display sources possible (receiver, DVD player, DVD recorder, VCR, PC etc.).

This device is only suitable for dry indoor use. This appliance is intended solely for private domestic use and may not be used for industrial and commercial purposes. We exclude liability in principle, if the device is not used as intended, or unauthorized modifications have been made. To operate your LED TV in extreme ambient conditions may cause the damage of the device.

## Preparation

For ventilation, leave a free space of at least 10 cm all around the set. To prevent any fault and unsafe situations, please do not place any objects on top of the set. Use this device in moderate climates.

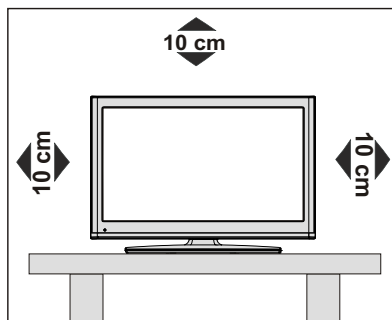

## Safety Precautions

**Read the following recommended safety precautions carefully.**

### Power Source

The TV set should be operated only from a 220-240V AC, 50 Hz outlet. Ensure that you select the correct voltage setting for your convenience.

### Power Cord

Do not place the set, a piece of furniture, etc. on the power cord or pinch the cord. Handle the power cord by the plug. Do not unplug the appliance by pulling from the power cord and never touch the power cord with wet hands as this could cause a short circuit or electric shock. Never make a knot in the cord or tie it with other cords. The power cord should be placed in such a way that they are not likely to be stepped on. A damaged power cord

can cause fire or give you an electric shock. When it is damaged and needs to be replaced, it should be done by qualified personnel.

### Moisture and Water

Do not use this device in a humid and damp place (avoid the bathroom, the sink in the kitchen etc). Do not expose this device to rain or water, as this may be dangerous and do not place objects filled with liquids, such as flower vases, on top.



If any solid object or liquid falls into the cabinet, unplug the TV and have it checked by qualified personnel before operating it any further.

### Cleaning

Before cleaning, unplug the TV set from the wall outlet. Do not use liquid or aerosol cleaners. Use a soft, dry cloth.



### Ventilation

The slots and openings on the TV set are intended for ventilation and to ensure reliable operation. To prevent overheating, these openings must not be blocked or covered in anyway.

### Heat and Flames

The set should not be placed near to open flames or sources of intense heat such as an electric heater. Ensure that no open flame sources, such as candles, are placed on top of the TV. Batteries should not be exposed to excessive heat such as sunshine, fire or the like.



### Lightning

In case of storm and lightning or when going on holiday, disconnect the power cord from the wall outlet.



### Replacement Parts

When replacement parts are required, make sure that the service technician has used replacement parts, which are specified by the manufacturer or have the same specifications as the original one. Unauthorized substitutions may result in fire, electrical shock or other hazards.

### Servicing

Please refer all servicing to qualified personnel. Do not remove the cover yourself as this may result in an electric shock.



### Waste Disposal

Instructions for waste disposal:

- Packaging and packaging aids are recyclable and should principally be recycled. Packaging

materials, such as a foil bag, must be kept away from children.

- Batteries, including those which are heavy metal-free, should not be disposed of with household waste. Please dispose of used batteries in an environmentally friendly manner. Find out about the legal regulations which apply in your area.
- Do not try to recharge batteries, there is a danger of explosion. Replace batteries only with the same or equivalent type.

### Information for users in the EU

This symbol on the product or on its packaging means that your electrical device should be disposed at the end of its service life separately from your household wastes. There are separate collection systems for recycling in the EU. For more information, please contact the local authority or the dealer where you purchased the product.



### Disconnecting the Device

The mains plug is used to disconnect the TV set from the mains and therefore it must remain readily operable.

### Headphone Volume

Excessive sound pressure from earphones and headphones can cause hearing loss.



### Installation

To prevent injury, this device must be securely attached to the wall in accordance with the installation instructions when mounted to the wall (if the option is available).

### LCD Screen

The LCD panel is a very high technology product with about a million thin film transistors, giving you fine picture details. Occasionally, a few non-active pixels may appear on the screen as a fixed blue, green or red point. Please note that this does not affect the performance of your product.

Warning! Do not leave your TV in standby or operating mode when you leave your house.

### Connection to a Television Distribution System (Cable TV etc.) from Tuner

Devices connected to the protective earthing of the building installation through the mains connection or through other apparatus with a connection to protective earthing-and to a television distribution system using a coaxial cable, may in some circumstances create a fire hazard.



Connection to a cable distribution system has therefore to be provided through a device providing electrical isolation below a certain frequency range (galvanic isolator, see EN 60728-11).

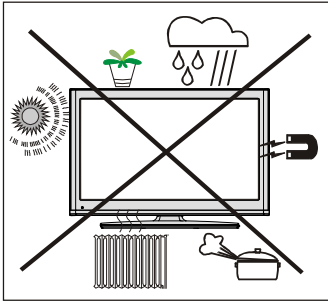

### Electrical devices not in the hands of children

Never let children use electrical devices unsupervised. Children cannot always recognize properly any possible danger. Batteries / accumulators can be life threatening when swallowed. Store batteries out of the reach of small children. In case of swallowing a battery, medical aid has to be sought immediately. Also keep the packaging away from children as there is danger of suffocation.

The Standby button does not fully switch off this product. Moreover, the device continues to consume power in standby mode. In order to separate the device completely from mains, the mains plug has to be pulled from the mains socket. Because of that the device should be set up in a way, that an unobstructed access to the mains socket is guaranteed, so that in case of emergency the mains plug can be pulled immediately. During periods of prolonged non-use, the TV should be disconnected from the mains power supply.

### TRADEMARK ACKNOWLEDGMENT

“Dolby” and the double-D symbol are trademarks of Dolby Laboratories.



### Licence Notification (Optional)

Manufactured under license from Dolby Laboratories.

## Package Contents

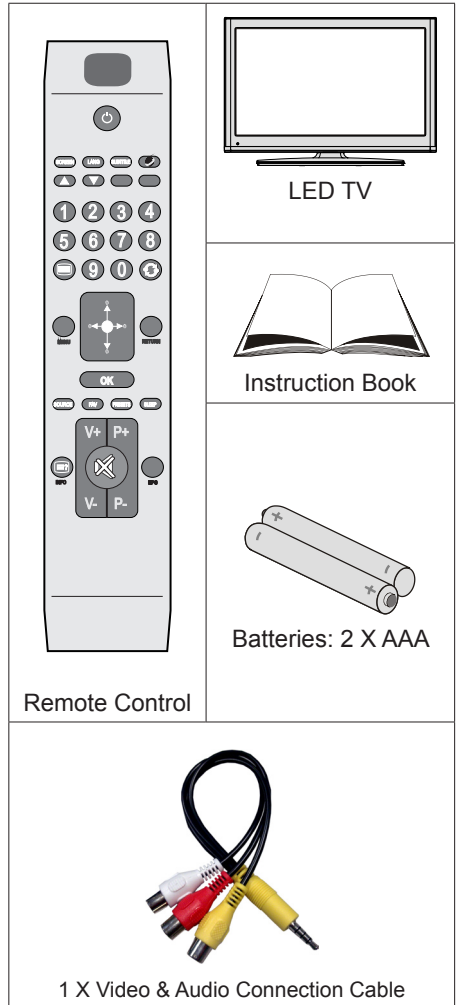

Remote Control

LED TV

Instruction Book

Batteries: 2 X AAA

1 X Video & Audio Connection Cable

*Note: You should check the contents after opening your purchase and make sure that every item is included.*

*Note: The HDMI connection between PC and TV may cause radio interference in which case it is recommended to use VGA(DSUB-15) connection.*

## Environmental Information

- This television is designed to consume less energy to save the environment.

You not only help to save the environment but you can also save money by reducing electricity bills thanks to the energy efficiency features of this TV. To reduce energy consumption, you should take the following steps:

- You can use the Power Save Mode setting, located in the **Other settings** menu. If you set the Power Save Mode as On, the TV will switch to energy-saving mode and the luminance level of the TV set will be decreased to optimum level. Note that some picture settings will be unavailable when the TV is in Power Save Mode.



- When the TV is not in use, please switch off or disconnect the TV from the mains plug. This will also reduce energy consumption.
- Note that annually, using the TV set in Power Save Mode has more power efficiency than disconnecting the TV from the mains plug instead of keeping stand-by mode. Therefore it is highly recommended to activate Power Save Mode setting to reduce your annual power consumption. And also it is recommended to disconnect the TV from the mains plug to save energy more when you do not use.
- Please helps us to save environment by following these steps.

### Repair Information

Please refer all servicing to qualified personnel. Only qualified personnel must repair the TV. Please contact your local dealer, where you purchased this TV for further information.

## Remote Control Buttons

1. Standby
2. Mono/Stereo - Dual I-II / Current Language (in DVB channels)
3. Image size
4. Green button
5. Red button
6. Numeric buttons
7. Teletext / Mix(in TXT mode)
8. Cursor Left
9. Menu on-off
10. AV / Source selection
11. Favourite Mode Selection(in DVB channels)
12. Volume Up
13. Info / Reveal (in TXT mode)
14. Mute
15. Volume Down
16. Programme Down / Page up(in DVB channels)
17. Electronic programme guide(in DVB channels)
18. Programme Up / Page down(in DVB channels)
19. Sleep Timer
20. Picture mode selection
21. Okay (Confirm) / Hold (in TXT mode)/ Edit Channel List
22. Cursor Down
23. Exit / Return / Index page (in TXT mode)
24. Cursor Right / Subpage (in TXT mode)
25. Cursor Up
26. Previous programme
27. Yellow button
28. Blue button
29. No function
30. Subtitle on-off (in DVB channels)

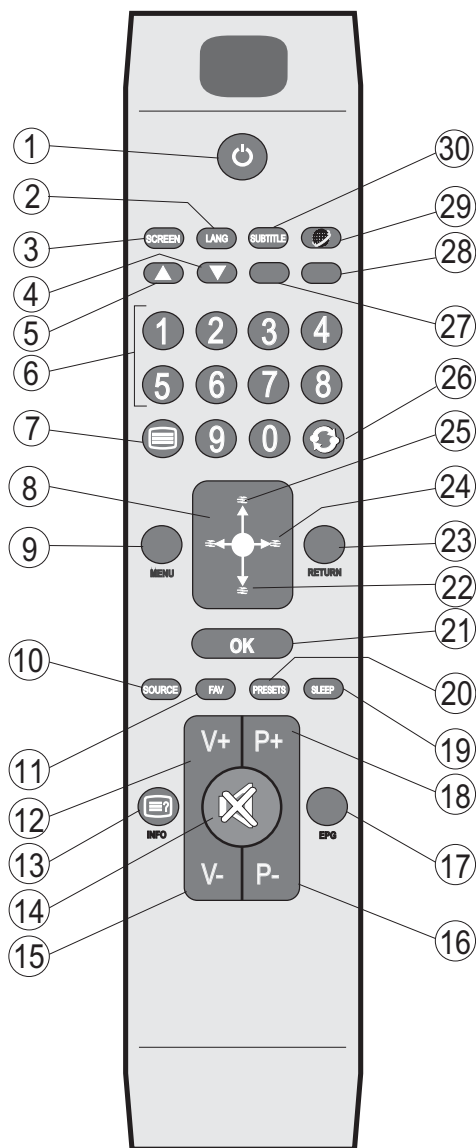

**These buttons change according to the model:**

 / Web Browser (optional) (\*) or Pip / Pip function (optional) (\*)

## TV and Operating Control Switch

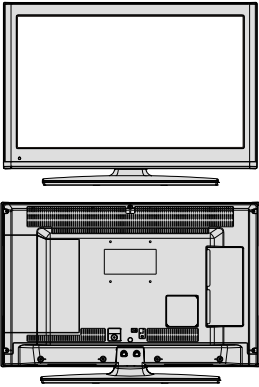
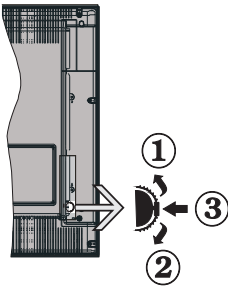
FRONT and REAR VIEW	Control switch VIEW	Control Switch
		<ol style="list-style-type: none"> <li>1. Up direction</li> <li>2. Down direction</li> <li>3. Programme/Volume / AV / Standby-On selection switch</li> </ol> <p><i>Note: You can move the switch, upward or downward to change the volume. If you want to change channels, press the middle of the switch once (Position 3) and then move upward or downward. If you press the middle of the switch once more, source OSD will be displayed. If you press the middle of the switch and hold about a few seconds, the TV will switch to standby mode. Main menu OSD cannot be displayed via control buttons.</i></p>

## Viewing the Connections - Back Connectors

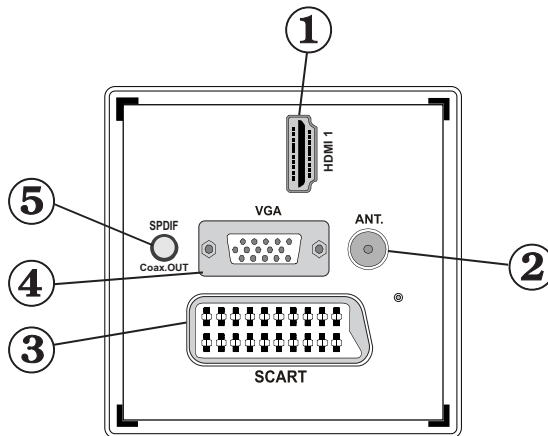

### 1. HDMI 1: HDMI Input

**HDMI Inputs** are for connecting a device that has a **HDMI** socket. Your TV is capable of displaying High Definition pictures from devices such as a High Definition Satellite Receiver or DVD Player. These devices must be connected via the HDMI sockets or Component Socket. These sockets can accept either 720p or 1080i signals. No sound connection is needed for a HDMI to HDMI connection.

### 2. RF Input connects to an aerial antenna system.

*Note: If you use a decoder or a media recorder, you should connect the aerial cable through the device to the television with an appropriate antenna cable, as shown in the illustration in the following pages.*

### 3. SCART input or output for external devices. Connect the SCART cable between SCART socket on TV and SCART socket on your external device (such as a decoder, a VCR or a DVD player).

**Note:** If an external device is connected via the SCART socket, the TV will automatically switch to AV mode.

**Note:** S-VHS signal is supported via the scart socket (optional).

- VGA Input** is for connecting a personal computer to the TV set.  
Connect the PC cable between the **PC INPUT** on the TV and the PC output on your PC.  
**Note:** You can use YPbPr to VGA cable (not supplied) to enable YPbPr signal via VGA input.  
**WARNING:** You cannot use VGA and YPbPr at the same time.
- SPDIF Out** outputs audio signals of the currently watched source.  
Use an **SPDIF cable** to transfer audio signals to a device that has SPDIF input.

## Viewing the Connections - Side Connectors

- The CI Slot is used for inserting a CI card. A CI card allows you to view all the channels that you subscribe to. For more information, see "Conditional Access" section.
- Side USB input.
- Side audio-video connection input is used for connecting video and audio signals of external devices. To make a video connection, you must use the supplied AV connection cable for enabling connection. First, plug singular jack of the cable to the TV's Side AV socket. Afterwards, insert your video cable's (not supplied) connector into the YELLOW input (located on the plural side) of the supplied AV connection cable. Colours of the connected jacks should match.

To enable audio connection, you must use RED and WHITE inputs of the side AV connection cable. Afterwards, insert your device's audio cable's connectors into the RED and WHITE jack of the supplied side AV connection cable. Colours of the connected jacks should match.

*Note: You should use audio inputs of side AV connection cable (RED & WHITE) to enable sound connection when connecting a device to your TV by using PC or COMPONENT VIDEO input.*

- The headphone jack is used for connecting an external headphone to the system.  
Connect to the HEADPHONE jack to listen to the TV from headphones.
- Volume/ Programme/ Source and Standby-On switch

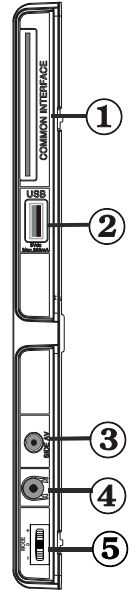

## Aerial Connection

- Connect the aerial to the **AERIAL INPUT (ANT)** socket located at the rear of the TV.

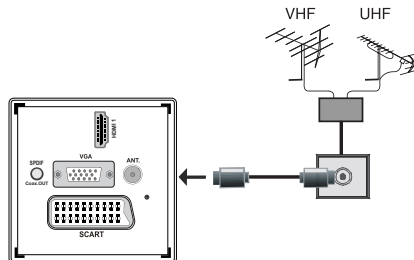

## Power Connection

**IMPORTANT:** The TV set is designed to operate on 220-240V AC, 50 Hz.

- After unpacking, allow the TV set to reach the ambient room temperature before you connect the set to the mains. Plug the power cable to the mains socket outlet.

## Using USB Media

- You can connect USB devices to your TV by using the USB input of the TV. This feature allows you to display/play JPG, MP3 and video files stored on a USB stick.
- It is possible that certain types of USB devices (e.g. MP3 Players) may not be compatible with this TV.
- You should back up your files before making any connections to the TV set in order to avoid any possible data loss. Note that the manufacturer will not be responsible for any file damage or data loss.
- Do not pull out USB module while playing a file.

**CAUTION: Quickly plugging and unplugging USB devices, is a very hazardous operation. Do not repeatedly quickly plug and unplug the drive. This may cause physical damage to the USB player and especially the USB device itself.**

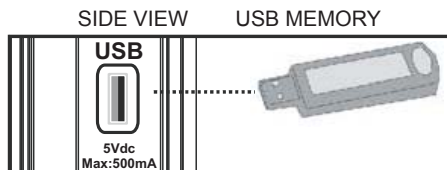

### USB Memory Connection

**IMPORTANT: The TV should be switched off while plugging or unplugging a USB device.** Plug your USB devices to the USB input of the TV. You can connect a USB device to your TV by using the USB input of the TV.

*Note: It is possible certain types of hard disk drives are not supported.*

## Connecting the TV to a PC

For displaying your computer's screen image on your TV, you can connect your computer to the TV set. Power off both computer and display before making any connections. Use a 15-pin D-sub display cable to connect a PC to the TV. When the connection is made, switch to PC source. See the **Input selection** section. Set the resolution that suits your viewing requirements. Resolution information can be found in the appendix.

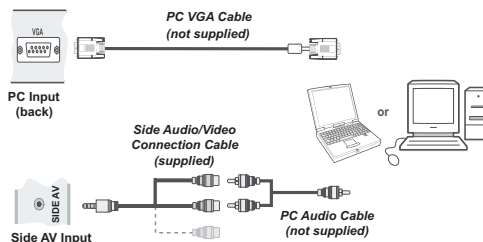

*Note: If you connect a PC to the TV using HDMI connection, radio interference may occur. Therefore this type of connection is not recommended. You should use VGA connection instead.*

## Using Side AV Connectors

You can connect a range of optional equipment to your LED TV using side connectors of the TV.

- For connecting a camcorder or camera, you should use **SIDE AV** socket (side). To do this, you must use the supplied **video/audio connection cable**. First, plug single jack of the cable to the TV's **AV IN** socket (side). Afterwards, insert your camera cable's (*not supplied*) connectors into the plural part of the **video/audio connection cable**. Colours of the connected jacks should match. See illustration below.
- Afterwards, you should switch to **Side AV** source. See the section **Input selection** in the following sections for more information.

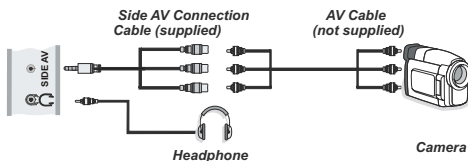

- To listen the TV sound from headphones, you should connect headphones to your TV by using the **HEADPHONE** jack as illustrated above.

## Connecting to a DVD Player via HDMI

Please refer to your DVD player's instruction book for additional information. Power off both the TV and the device before making any connections.

Note: Not all cables shown in the illustration are supplied.

- If your DVD player has an **HDMI** socket, you can connect via **HDMI** for better video and audio quality.

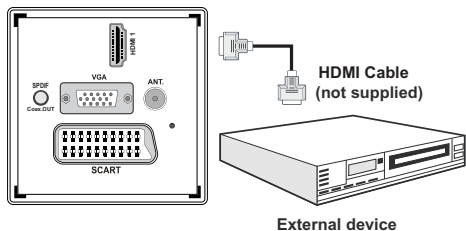

External device

- When you connect to DVD player as illustrated above, switch to the connected **HDMI** source. See, **Input Selection** section for more information on changing sources.

## Connecting to a DVD Player

- Some DVD players are connected through COMPONENT SOCKETS (YPbPr). YPbPr can be used only when you connect a device that has a YPbPr output through the PC input with YPbPr to PC cable (YPbPr cable is not supplied).
- When the connection is made, switch to YPbPr source. See, "Input selection" section.
- To enable audio connection, use the **VGA/Component Audio cable**. First, plug single jack of the cable to the TV. Afterwards, insert your DVD player's audio cable's connectors into the plural part of the **VGA/Component audio connection cable** (see illustration below). Colours of the connected jacks should match (RED & WHITE).

### Audio Connection

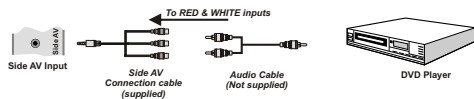

### Video Connection

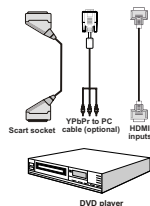

DVD player

- When the connection is made, switch to **YPbPr** source. See, **Input selection** section.
- You may also connect through the **SCART** input.

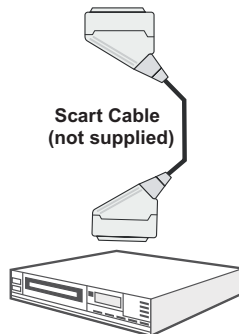
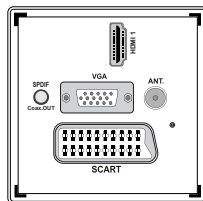

External device

Note: These three methods of connection perform the same function but in different levels of quality. It is not necessary to connect by all three methods.

## Remote Control Handset

### Inserting Batteries

- Remove the battery cover located on the back of the handset by gently pulling backwards from the indicated part.
- Insert two **AAA/R3** or equivalent type batteries inside. Observe the correct polarity (+/-) when inserting batteries and replace the battery cover.

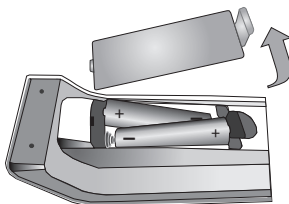

Note: Remove the batteries from the remote control handset when it is not to be used for a long period. Otherwise it can be damaged due to any leakage of batteries. Remote range is approximately 7m/23ft.

## Switching On/Off

### To Switch the TV On

- Connect the power cord to the 220-240V AC, 50 Hz.
- Press STANDBY touch button. Then the standby LED lights up.
- To switch on the TV from standby mode either:
  - Press the “” button, **P+** or **P-** or a numeric button on the remote control.
  - Press the control switch right side of the TV. The TV will then switch on.

*Note: If you switch on your TV via **P+** or **P-** buttons on the remote control or on the TV set, the programme that you were watching last will be reselected.*

By either method the TV will switch on.

### To Switch the TV Off

- Press the “” button on the remote control or hold the control switch on the Tv until shut down , so the TV will switch to standby mode.
- To power down the TV completely, unplug the power cord from the mains socket.

*Note: When the TV is switched to standby mode, the standby LED can blink to indicate that features such as Standby Search, Over Air Download or Timer is active.*

### Digital Teletext

- Press the “” button.
- The digital teletext information appears.
- Operate it with the coloured buttons, cursor buttons and **OK** button.

The operation method may differ depending on the contents of the digital teletext.

Follow the instructions displayed on the digital teletext screen.

- When the “” button is pressed, the TV returns to television broadcasting.
- The aspect ratio (picture shape) when watching a channel with just digital teletext broadcasting is the same as the aspect ratio of the picture viewed previously.

## Input Selection

Once you have connected external systems to your TV, you can switch to different input sources. Press “**SOURCE**” button on your remote control consecutively for directly changing sources.

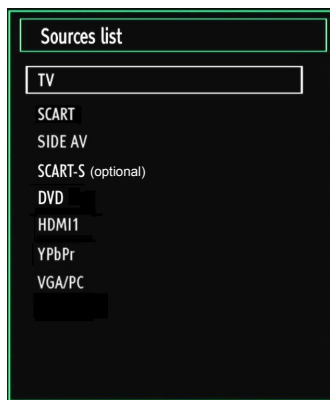

*Note: YPbPr mode can be used only when you connect a device that has a YPbPr output through the PC input with YPbPr to PC cable (not supplied).*

## Basic Operations

**You can operate your TV using both the remote control and onset buttons.**

### Operation with the Buttons on the TV

#### Volume Setting

- You can move the control switch upward or downward for changing the volume. To increase volume, please move the switch upward. Move the switch downward to decrease the volume. A volume level scale (slider) will be displayed on the screen.

#### Programme Selection

- First press the control switch once to change channel. You can move the switch upward to select the next programme or move it downward to select the previous programme.

#### Viewing Main Menu

- Menu screen cannot be displayed by using the control switch.

#### AV Mode

- Press the control switch consecutively until the source OSD is displayed on the screen.

#### Operation with the Remote Control

- The remote control of your TV is designed to control all the functions of the model you selected. The functions will be described in accordance with the menu system of your TV.



## Volume Setting

- Press “**V+**” button to increase the volume. Press “**V-**” button to decrease the volume. A volume level scale (slider) will be displayed on the screen.

## Programme Selection (Previous or Next Programme)

- Press “**P-**” button to select the previous programme.
- Press “**P+**” button to select the next programme.

## Programme Selection (Direct Access)

- Press the numeric buttons on the remote control to select programmes between 0 and 9. The TV will switch to the selected programme.

## Viewing Electronic Programme Guide (EPG)

You can view the electronic programme guide (EPG) to see information about available programmes. To view the EPG menu please press **EPG** button on the remote control.

- Press “**▼**”/“**▲**” buttons to navigate through channels.
- Press “**◀**”/“**▶**” buttons to navigate through the programme list.
- Please note that event information is updated automatically. If there is no event information data available for channels, the EPG will be displayed with blanks.

Channels	Current Event	Next Event
1. BBC ONE	Holby City	Hustle
2. BBC TWO	Springwatch	Mary, Queen of Shops
7. BBC THREE	Filthy Rich and Homeless	Eust My Ass
70. CBBC Channel	This is CBBC!	This is CBBC!
80. BBC NEWS 24	BBC News	BBC News
105. BBC1	BBC1	BBC1
503. ITV HD Trial	No Information	No Information
504. Ch4 HD Trial	No Information	No Information
505. five HD Trial	No Information	No Information
800. Sky News	No Information	No Information
801. CNBC Europe	No Information	No Information
802. TVSMONDE EUROPE	No Information	No Information

**OK (Options):** Displays programme options including “**Select Channel**” option.

**INFO (Event Details):** Displays the programmes in detail.

**Green button:** Programme schedule will be listed

**Yellow button:** Display EPG data in accordane with timeline schedule

**Blue button (Filter):** Views filtering options.

Programme Guide	Thu 27/07, 12:00-14:00
1. BBC ONE	20:00 Hustle
2. BBC TWO	
7. BBC THREE	
70. CBBC Channel	
80. BBC NEWS 24	
105. BBC1	
503. ITV HD Trial	
504. Ch4 HD Trial	
505. five HD Trial	
800. Sky News	
801. CNBC Europe	
802. TVSMONDE EUROPE	

**Red button (Prev Time Slice):** Displays the programmes of previous time slice.

**Green button (Next Time Slice):** Displays the programmes of the next time slice.

**Yellow button (Prev Day):** Displays the programmes of previous day.

**Blue button (Next day):** Displays the programmes of the next day.

**Numeric buttons (Jump):** Jumps to the preferred channel directly via numeric buttons.

**OK (Options):** Displays programme options including “**Select Channel**” option.

**Text button (Filter):** Views filtering options.

**INFO (Details):** Displays the programmes in detail.

Programme Guide	Thu 07/06	21:00	Thu 07/06 20:29	22:00
1. BBC ONE	Holby City	Mary, Queen of Shops	Hustle	
2. BBC TWO	Springwatch	Mary, Queen of Shops		
7. BBC THREE	Filthy Rich and Homeless	Bust My Ass		
70. CBBC Channel	This is CBBC!			
80. BBC NEWS 24	BBC News	BBC News		
105. BBC1	BBC1			
503. ITV HD Trial				
504. Ch4 HD Trial				
505. five HD Trial				
800. Sky News				
801. CNBC Europe				
802. TVSMONDE EU..				

**Red button (Prev Day):** Displays the programmes of previous day..

**Green button (Next day):** Displays the programmes of the next day.

**Yellow button (Zoom):** Expands programme information.

**Blue button (Filter):** Views filtering options.

**INFO (Details):** Displays the programmes in detail.

**Numeric buttons (Jump):** Jumps to the preferred channel directly via numeric buttons.

**OK (Options):** Displays programme options including “**Select Channel**” option.

**Text (Search):** Displays “**Guide Search**” menu.

**SUBTTL:** Press **SUBTITLE** button to view Select Genre menu. Using this feature, you can search the programme guide database in accordance with the genre. Info available in the programme guide will

be searched and results matching your criteria will be listed.

**(Now)** : Shows the current programme.

## First Time Installation

**IMPORTANT: Ensure that the aerial is connected and a Common Interface module is not inserted before switching on the TV for the first time installation.**

- When the TV is operated for the first time, the installation wizard will guide you through the process. First, the language selection screen will be displayed:

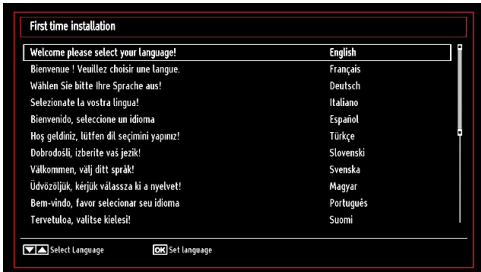

- Use “▼” or “▲” buttons to select your language and press **OK** button to set the selected language and continue.
- After selecting the language, “Welcome!” screen will be displayed, requiring you to set **Country, Search Type, Teletext Language and Scan Encrypted** options.



- By pressing “◀” or “▶” button, select the **country** you want to set and press “▼” button to highlight **Search Type** option. Use “◀” or “▶” to set the desired search type. Available search types are Digital and analog, digital only and analog only.
- When set, press “▼” to select **Teletext Language**. Use “◀” or “▶” to select the desired **Teletext Language**.
- Press **OK** button on the remote control to continue and the following message will be displayed on the screen:



To select the “Yes” or “No” option, highlight the item by using “◀” or “▶” buttons and press **OK** button.

Afterwards the following OSD will be displayed on the screen and the TV will search for both digital and analogue TV broadcasts.

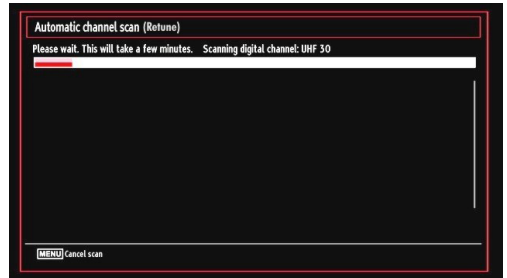

*Note: You can press “MENU” button to cancel.*

- After all the available stations are stored, Channel List will be displayed on the screen. If you like the sort channels, according to the LCN, please select “Yes” and than press “OK”.

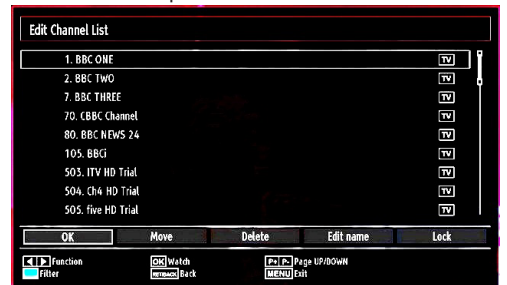

- Press **OK** button to quit channel list and watch TV.

## Installation

Press “MENU” button on the remote control and select **Installation** by using “◀” or “▶” button. Press **OK** button and the following menu screen will be displayed.

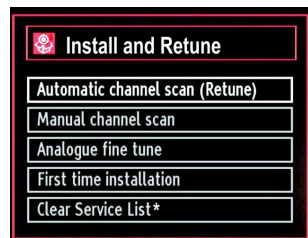

Select **Automatic Channel Scan (Retune)** by using “▼”/“▲” button and press **OK** button. **Automatic Channel Scan (Retune)** options will be displayed. You can select options by using “▼”/“▲” and **OK** buttons.

## Auto Channel Scan (Retune) Menu Operation

**Analogue:** Searches and stores analogue stations.

**Digital & Analogue:** Searches and stores both analogue and aerial DVB stations.

- Whenever you select an automatic search type and press **OK** button, a confirmation screen will appear on the screen. To start installation process, select **Yes**, to cancel select **No** by using “◀” or “▶” and **OK** button.
- After the auto channel scan type is set and selected and confirmed, the installation process will start and the progress bar will move along. Press “**MENU**” button to cancel process. Located channels are not stored if the process is cancelled.

## Analogue Manual Search

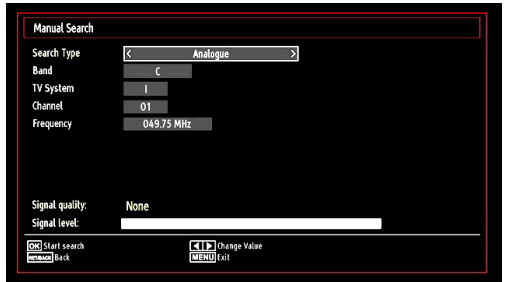

After selecting search type as analogue, you can use “▼”/“▲” button to highlight an item and then press “◀” or “▶” button to set an option.

Enter the channel number or frequency using the numeric buttons. You can then press **OK** button to search. When the channel is located, any new channels that are not on the list will be stored.

## Analogue Fine Tune

- Select **Analogue Fine Tune** from the Installation menu by using “▼” or “▲” and **OK** buttons. The analogue fine tune screen will be displayed. The Analogue Fine Tune feature will not be available if there are no analogue channels, digital channels and external sources stored.
- Press **OK** button to proceed. Use “◀” or “▶” button to set Fine Tune. When finished, press **OK** button again.

## Manual Tuning

**HINT:** This feature can be used for direct broadcast entry.

- Select **Manual Channel Scan** from the Installation menu by using “▼”/“▲” and **OK** buttons. Manual Scan options screen will be displayed.
- Select the desired **Search Type** using “◀” or “▶” button. Manual search options will change accordingly. Use “▼”/“▲” button to highlight an item and then press “◀” or “▶” button to set an option. You can press “**MENU**” button to cancel.

## Managing Stations: Channel List

The TV sorts all stored stations in the Channel List. You can edit this channel list, set favourites or set active stations to be listed by using the Channel List options.

- Press “**MENU**” button to view main menu. Select the Channel List item by using “◀” or “▶” button. Press **OK** to view menu contents.

## Digital Manual Search



In manual channel scan, the number of the multiplex or frequency are entered manually and only that multiplex or frequency are searched for the channels. After selecting search type as **Digital**, you can enter the multiplex or frequency number using the numeric buttons and press **OK** button to search.

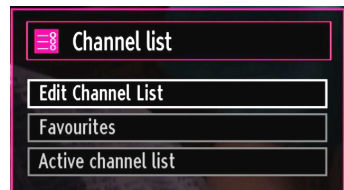

Select **Edit Channel List** to manage all stored channels. Use “◀” or “▶” and **OK** buttons to select Edit Channel List.

## Operating the Channel List

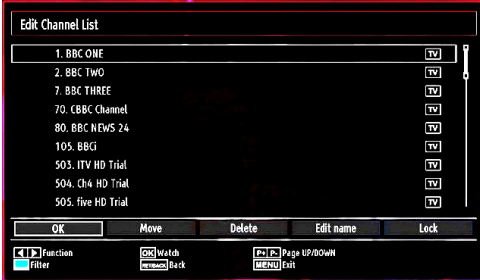

- Press “▼” or “▲” button to select the channel that will be processed. Press “◀” or “▶” button to select a function on Channel List menu.
- Use **P+** or **P-** buttons to move page up or down.
- Press **BLUE** button to view filtering options.
- Press “**MENU**” button to exit.

## Moving a Channel

- First select the desired channel. Select Move option in the channel list and press the **OK** button.
- Edit Number screen will be displayed. Enter the desired channel number by using the numeric buttons on the remote control. If there is a previously stored channel on that number, a warning screen will be displayed. Select Yes if you want to move the channel and press **OK**.
- Press the **OK** button to process. Selected channel is now moved.

## Deleting a Channel

You can press **GREEN** button to tag/untag all channels; **YELLOW** button to tag/untag channel.

- Select the channel that you want to delete and select **Delete** option. Press the **OK** button to continue.
- A warning screen will appear. Select **YES** to delete, select **No** to cancel. Press the **OK** button to continue.

## Renaming a Channel

- Select the channel that you want to rename and select **Edit Name** option. Press **OK** button to continue.
- Pressing “◀” or “▶” button moves to the previous/next character. Pressing “▼” or “▲” button toggles the current character, i.e., ‘b’ character becomes ‘a’ by “▼” and ‘c’ by “▲”. Pressing the numeric buttons ‘0...9’ replaces the highlighted character with the characters printed above the button one by one as the button is pressed.
- When finished, press the **OK** button to save. Press “**MENU**” to cancel.

## Locking a Channel

You can press **GREEN** button to tag/untag all channels; **YELLOW** button to tag/untag a single channel.

- Select the channel that you want to lock and select **Lock** option. Press **OK** button to continue.
- You will be asked to enter parental control PIN. Default PIN is set as **0000**. Enter the PIN number.

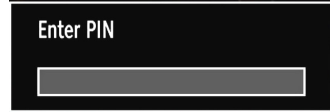

- Press **OK** button when the desired channel is highlighted to lock/unlock the channel. The Lock symbol will be displayed next to the selected channel.

## Managing Stations: Favourites

You can create a list of favourite programmes.

- Press “**MENU**” button to view the main menu. Select Channel List item by using “◀” or “▶” button. Press **OK** to view menu contents.
- Select **Favourites** to manage favourite list. Use “▼”/“▲” and **OK** buttons to select **Favourites**.
- You can set various channels as favourites so that only the favourite channels are navigated.



- Select a channel by using “▼” or “▲” button. Press **OK** button to add selected channel to favourites list. Press **OK** button again to remove.

## Button Functions

- **OK**: Add/remove a station.
- **YELLOW**: Tag/untag a channel.
- **GREEN**: Tag/untag all channels.
- **BLUE**: Displays filtering options.

## Managing Stations: Sorting the Channel List

You can select broadcasts to be listed in the channel list. To display specific types of broadcast, you should use the Active channel list setting.

Select Active channel list from the Channel list menu by using “◀” or “▶” button. Press **OK** button to continue.

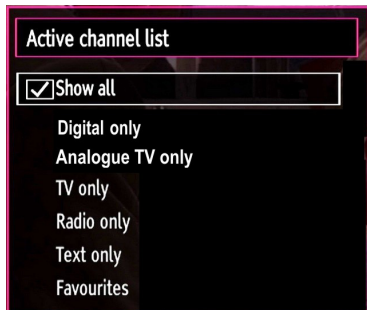

You can select a broadcast type option from the list by using “▼” / “▲” and **OK** buttons.

## On-Screen Information

You can press “**INFO**” button to display on-screen information. Details of the station and current programme will be displayed on the information banner.



The information banner gives information on the channel selected and the programmes on it. The name of the channel is displayed, along with its channel list number.

*Hint: Not all channels broadcast the programme data. If the name and time of the programme are not available, then the information banner will be displayed with blanks.*

If the selected channel is locked, you must enter the correct four-digit numeric code to view the channel (default code is **0000**). “**Enter PIN**” will be displayed on the screen.

## Media Playback Using Media Browser

If the USB stick is not recognized after power off/on or First Time Installation, unplug the USB device, turn the TV off and on again and re-insert the USB device.

To display the Media Browser window, press either “**MENU**” button on the remote control and then select Media Browser by pressing “◀” or “▶” button. Press **OK** button to continue. Media Browser menu options will be displayed.

**Also, when you plug USB devices, media browser screen will be displayed automatically:**

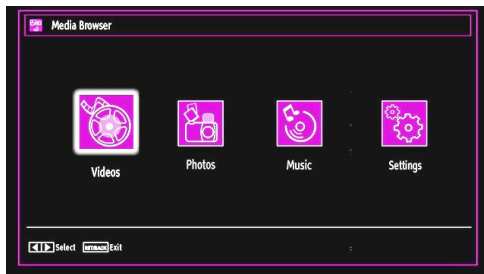

You can play music, picture and video files from the connected USB memory stick. Use “◀” or “▶” button to select Videos, Photos, Music or Settings.

### Viewing Videos via USB



When you select Videos from the main options, available video files will be filtered and listed on this screen. You can use “▼” or “▲” button to select a video file and press **OK** button to play a video. If you select a subtitle file and press **OK** button, you can select or deselect that subtitle file. The following menu will be displayed while playing a video file:

**Jump (Numeric buttons):** The TV will jump to the file starting with the letter you input via the numeric buttons on your remote control.

**Play This (OK button):** Plays the selected file.

**Play (GREEN button):** Plays all media files starting with the selected one.

**Lang (Play Preview)**: Displays selected file in a small preview screen.

**INFO**: Changes filter options.

**FAV**: Sorts files by name.



**Play (red button)**: Starts the video playback.

**Stop (blue button)**: Stops the video playback.

**Pause (OK button)**: Pause the video playback.

**Rewind (◀◀ button)**: Goes backward.

**Forward (▶▶ button)**: Goes forward.

**Subtitle/Audio (LANG button)**: Sets subtitle/Audio.

**Yellow**: Opens subtitle time correction menu.

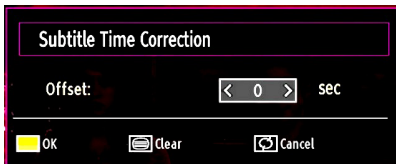

Press **RETURN** button to switch back to previous menu.

## Viewing Photos via USB

When you select Photos from the main options, available image files will be filtered and listed on this screen.

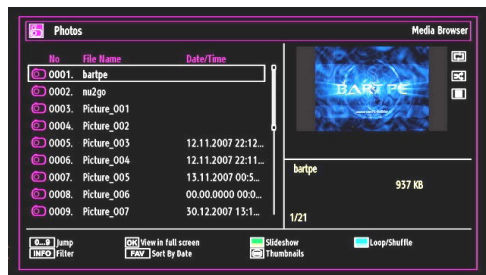

**Jump (Numeric buttons)**: Jump to selected file using the numeric buttons.

**OK**: Views the selected picture in full screen.

**Slideshow (GREEN button)**: Starts the slideshow using all images.

**TXT button**: Views images in thumbnails.

**RED button**: Sorts files by date.

**YELLOW button**: Toggles viewing style.

**BLUE button**: Changes media type.

## Slideshow Options

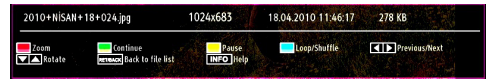

**Pause (Yellow button)**: Pauses the slideshow.

**Continue (Green button)**: Continues the slideshow.

**Previous/Next (Left/Right buttons)**: Jumps to previous or next file on slideshow.

**Rotate (Up/Down buttons)**: Rotates the image using up/down buttons.

**Loop/Shuffle (Blue button)**: Press once to disable Loop. Press again to disable both Loop and Shuffle. Press once more to enable only Shuffle. Press again to enable all. You can follow the disabled functions with the change of the icons.

**RET/BACK**: Back to file list.

**INFO**: Displays help screen.

## Viewing Music via USB

When you select Music from the main options, available audio files will be filtered and listed on this screen.



**0..9 (Numeric buttons)**: The TV will jump to the file starting with the letter you input via the numeric buttons on your remote control.

**Play This (OK button)**: Plays the selected file.

**Play (Green button)**: Plays all media files starting with the selected one.

**Stop (Red button)**: Stops playback.

**Pause (Yellow button)**: Pauses the selected playback.

**Previous/Next (Left/Right buttons)**: Jumps to previous or next file to play.

**FAV**: Sorts files by Title, Artist or Album.

**Note**: If the Viewing Style is set to Folder in Media Browser Settings, Music folder will be displayed as sorted and there is no need to sort files again by pressing FAV button.

**INFO**: Changes filter options.



**Loop/Shuffle (Blue button):** Press once to disable Loop. Press again to disable both Loop and Shuffle. Press once more to enable only Shuffle. Press again to enable all. You can follow the disabled functions with the change of the icons.

## Media Browser Settings

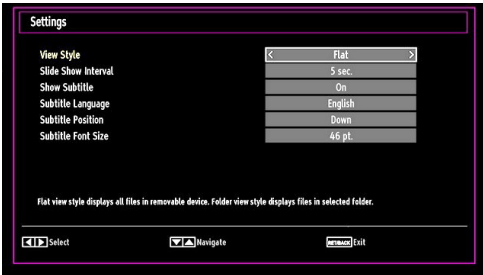

You can set your Media Browser preferences by using the Settings dialog. Press “▼” or “▲” button to highlight an item and use “◀” or “▶” button to set.

**View Style:** Sets default browsing mode.

**Slide Show Interval:** Sets slide show interval time.

**Show Subtitle:** Sets subtitle enabling preference.

**Subtitle Language:** Sets supported subtitle language.

**Subtitle Position:** Sets subtitle position as up or down.

**Subtitle Font Size:** Sets subtitle font size (max. 54pt).

## Changing Image Size: Picture Formats

• You can change the aspect ratio (image size) of the TV for viewing the picture in different zoom modes.

• Press the “**SCREEN**” button repeatedly to change the image size. Available zoom modes are listed below.

### Auto

When AUTO is selected, the aspect ratio of the screen is adjusted by the information provided by the selected source(if available)

**Note:** Auto mode only will be available in HDMI, YPbPr and DTV sources.

### 16:9

This uniformly stretches the left and right sides of a normal picture (4:3 aspect ratio) to fill the wide TV screen.

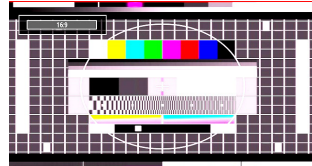

- For 16:9 aspect ratio pictures that have been squeezed into a normal picture (4:3 aspect ratio), use the **16:9** mode to restore the picture to its original shape.

### Subtitle

This zooms up the wide picture (16:9 aspect ratio) with subtitles to the full screen.

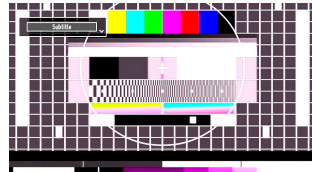

*Note:* You can shift to screen up or down by pressing “▼” / “▲” buttons while picture zoom is selected as, 14:9 Zoom, Cinema or Subtitle.

### 14:9

This zooms up the wide picture (14:9 aspect ratio) to the upper and lower limits of the screen.

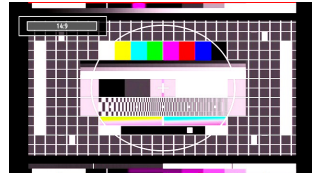

### 14:9 Zoom

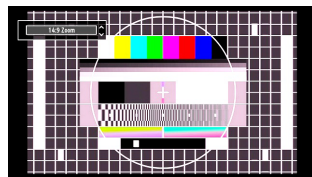

This option zooms to the 14:9 picture.

### 4:3

Use to view a normal picture (4:3 aspect ratio) as this is its original size.

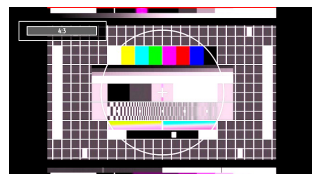

## Cinema

This zooms up the wide picture (16:9 aspect ratio) to the full screen.

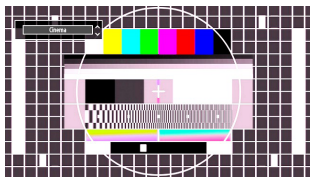

## Configuring Picture Settings

You can use different picture settings in detail.

Press “MENU” button and select the Picture icon by using “◀” or “▶” button. Press OK button to view Picture Settings menu.

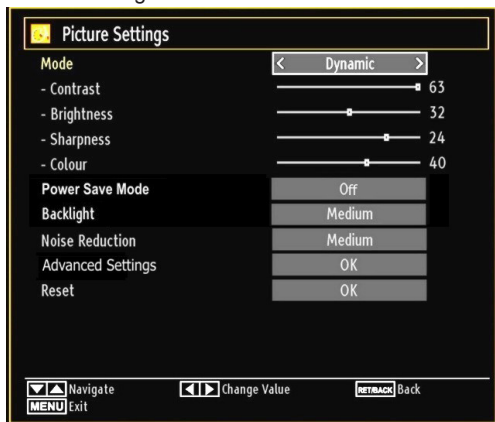

### Operating Picture Settings Menu Items

- Press “▼” or “▲” button to highlight a menu item.
- Use “◀” or “▶” button to set an item.
- Press “MENU” button to exit.

### Picture Settings Menu Items

**Mode:** For your viewing requirements, you can set various screen modes. The Picture mode can be set to one of these options: **Cinema, Game, Dynamic** and **Natural**.

**Contrast:** Sets the lightness and darkness values of the screen.

**Brightness:** Sets the brightness value for the screen.

**Sharpness:** Sets the sharpness value for the objects displayed on the screen.

**Colour:** Sets the colour value, adjusting the colors.

**Power Save Mode:** Use “▼” or “▲” button to select Power Save Mode.

Press “◀” or “▶” button to set Power Save Mode as On or Off.

See the section, “Environmental Information” in this manual for further information on Power Save Mode.

*Note :* The backlight function will be inactive if Power Save Mode is set to on.

**Backlight (optional):** This setting controls the backlight level and it can be set to Auto, Maximum, Minimum, Medium and Eco Mode.

*Note:* Backlight can not be activate in VGA or Media Browser mode or while picture mode is set as Game.

**Noise Reduction:** If the broadcast signal is weak and the picture is noisy, use **Noise Reduction** setting to reduce the noise amount. Noise Reduction can be set to one of these options: **Low, Medium, High** or **Off**.

### Advanced Settings

• **Colour Temp:** Sets the desired colour tone.

Setting **Cool** option gives white colours a slight blue stress.

For normal colours, select **Normal** option.

Setting **Warm** option gives white colours a slight red stress.

• **Picture Zoom:** Sets the picture size to **Auto, 16:9, Subtitle, 14:9, 14:9 Zoom, 4:3** or **Cinema**.

• **HDMI True Black (optional):** While watching from HDMI source, this feature will be visible in the Picture Settings menu. You can use this feature to enhance blackness in the picture. You can set this feature as “On” for activating HDMI True Black mode.

• **Film Mode (optional):** Films are recorded at a different number of frames per second to normal television programmes. Press “▼” or “▲” buttons to select Film mode. Press “◀” or “▶” buttons to set this feature Auto or Off. Turn this feature to Auto when you are watching films to see the fast motion scenes clearly.

• **Colour Shift:** Adjust the desired colour tone.

**Reset:** Resets the picture settings to factory default settings.

*While in VGA (PC) mode, some items in Picture menu will be unavailable. Instead, VGA mode settings will be added to the Picture Settings while in PC mode.*

### PC Picture Settings

For adjusting PC picture items, do the following:

Press “◀” or “▶” button to select Picture icon. Picture menu appears on the screen.

**Contrast, Brightness, Colour, Colour Temp and Picture Zoom** settings in this menu are identical to settings defined in TV picture menu under “Main Menu System”.

*Sound, Settings and Source settings are identical to the settings explained in main menu system.*



**PC Position:** Select this to display PC position menu items.

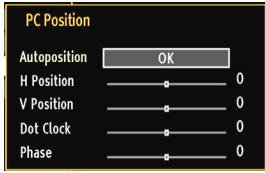

**Autoposition:** Automatically optimizes the display. Press **OK** to optimize.

**H Position:** This item shifts the image horizontally to right hand side or left hand side of the screen.

**V Position:** This item shifts the image vertically towards the top or bottom of the screen.

**Dot Clock:** Dot Clock adjustments correct the interference that appear as vertical banding in dot intensive presentations like spreadsheets or paragraphs or text in smaller fonts.

**Phase:** Depending on the resolution and scan frequency that you input to the TV set, you may see a hazy or noisy picture on the screen. In such a case you can use this item to get a clear picture by trial and error.

## Operating Sound Settings Menu Items

- Press “▼” or “▲” button to highlight a menu item.
- Use “◀” or “▶” button to set an item.
- Press “MENU” button to exit.

## Sound Settings Menu Items

**Volume:** Adjusts volume level.

**Equalizer:** Press **OK** button to view equalizer sub-menu.

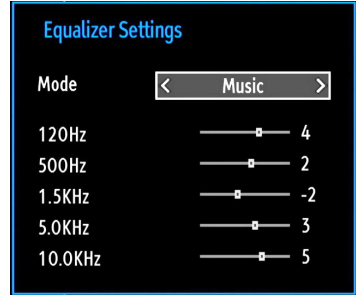

In the equalizer menu, the preset can be changed to **Music, Movie, Speech, Flat, Classic** and **User**. Press the “MENU” button to return to the previous menu.

**Note:** Equalizer menu settings can be changed manually only when the **Equalizer Mode** is in **User**.

**Balance:** This setting is used for emphasizing left or right speaker balance.

**Headphone:** Sets headphone volume.

**Sound Mode:** You can select Mono, Stereo, Dual I or Dual II mode, only if the selected channel supports that mode.

**AVL:** Automatic Volume Limiting (AVL) function sets the sound to obtain fixed output level between programmes (For instance, volume level of advertisements tend to be louder than programmes).

**Dynamic Bass:** Dynamic Bass is used to increase bass effect of the TV set.

**Digital Out:** Sets digital out audio type.

## Configuring Sound Settings

Sound settings can be configured according to your personal preferences.

Press “MENU” button and select the Sound icon by using “◀” or “▶” button. Press **OK** button to view Sound Settings menu.

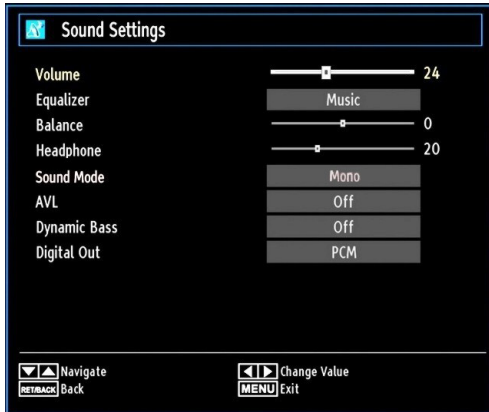

## Configuring Your TV's Settings

Detailed settings can be configured to suit your personal preferences.

Press “**MENU**” button and select Settings icon by using “◀” or “▶” button. Press **OK** button to view Settings menu.



### Operating Settings Menu Items

- Press “▼” or “▲” button to highlight a menu item.
- Press **OK** button to select an item.
- Press “**MENU**” button to exit.

### Settings Menu Items

**Conditional Access:** Controls conditional access modules when available.

**Language:** Configures language settings.

**Parental:** Configures parental settings.

**Timers:** Sets timers for selected programmes.

**Date/Time:** Sets date and time.

**Sources:** Enables or disables selected source options.

**Other Settings:** Displays other setting options of the TV set.

## Using a Conditional Access Module (not included)

**IMPORTANT:** Insert or remove the CI module only when the TV is **SWITCHED OFF**.

- In order to watch certain digital channels, a conditional access module (CAM) may be necessary. This module must be inserted in the CI slot of your TV.
- Obtain the Conditional Access Module (CAM) and the viewing card by subscribing to a pay channel company, then insert those to the TV using the following procedure.
- Insert the CAM and then the viewing card to the slot that is located in the terminal cover at the rear side of the TV.
- The CAM should be correctly inserted, it is impossible to insert fully if reversed. The CAM or the TV terminal may be damaged if the CAM is forcefully inserted.

Connect the TV to the mains supply, switch on and then wait for few moments until the card is activated.

- When no module is inserted, “**No Common Interface module detected**” message appears on the screen.
- Refer to the module instruction manual for details of the settings.

### Viewing Conditional Access Menu (\*)

(\*) These menu settings may change depending on the service provider.

Press “**MENU**” button and select the icon by using “◀” or “▶” button. Press **OK** button to view Settings menu. Use “▼” or “▲” button to highlight **Conditional Access** and press **OK** to view menu items.

## Configuring Language Preferences

You can operate the TV's language settings using this menu.

Press **"MENU"** button and select the Settings icon by using **"◀"** or **"▶"** button. Press **OK** button to view Settings menu. Use **"▼"** or **"▲"** button to highlight **Language** and press **OK** to continue:

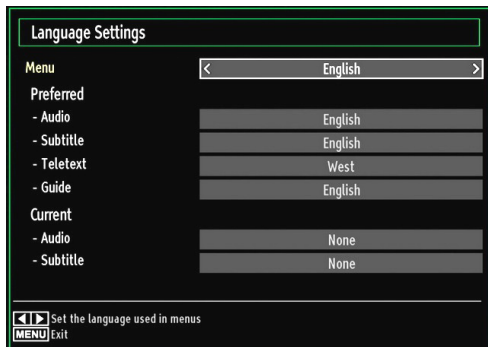

Use **"▼"** or **"▲"** button to set an item. Settings are stored automatically.

**Menu:** displays the system language.

### Preferred

These settings will be used if available. Otherwise the current settings will be used.

- **Audio:** Sets the preferred audio language.
- **Subtitle:** Sets the subtitle language. Selected language will be seen in subtitles.
- **Teletext:** Sets teletext language.
- **Guide:** Sets the preferred Guide language.

### Current (\*)

(\*) These settings can be changed if only the broadcaster supports. Otherwise, settings will not be available to be changed.

- **Audio:** Changes the audio language for the current channel.
- **Subtitle:** Sets the subtitle language for the current channel.

*Note: If the Country option is set to Denmark, Sweden, Norway or Finland, the Language Settings menu will function as described below:*

## Language Settings

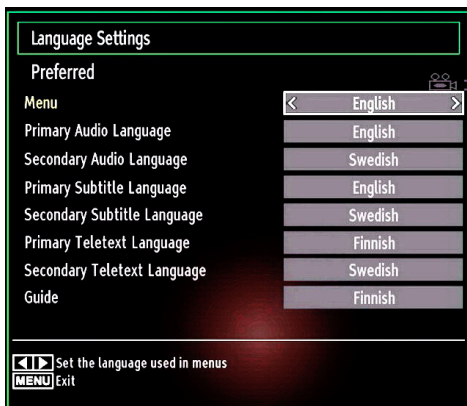

In the configuration menu, highlight the Language Settings item by pressing **"▼"** or **"▲"** buttons. Press **OK** and Language Settings submenu will be displayed on the screen:

Use **"▼"** or **"▲"** buttons to highlight the menu item that will be adjusted and then press **"◀"** or **"▶"** button to set.

Notes:

- System Language determines the on-screen menu language.
- Audio Language is used for selecting the soundtrack of a channels.
- Primary settings are the first priority when multiple choices are available on a broadcast. Secondary settings are the alternatives when the first options are not available.

## Parental Control

*To prohibit viewing of certain programmes, channels and menus can be locked by using the parental control system.*

*This function enables or disables the menu protection system and allows the PIN code to be changed.*

Press **"MENU"** button and select the Settings icon by using **"◀"** or **"▶"** button. Press **OK** button to view Settings menu. Use **"▼"** or **"▲"** button to highlight **Parental** and press **OK** to continue:



To display parental lock menu options, the PIN number should be entered. The factory default PIN number is **0000**.

After coding the correct PIN number, parental settings menu will be displayed:



## Parental Settings Menu Operation

- Select an item by using “▼” or “▲” button.
- Use “◀” or “▶” button to set an item.
- Press **OK** button to view more options.

**Menu Lock (optional):** Menu lock setting enables or disables the menu access. You can disable access to the installation menu or the whole menu system.

**Maturity Lock (optional):** When set, this option gets the maturity information from the broadcast and if this maturity level is disabled, disables access to the broadcast.

**Child Lock (optional):** When Child Lock is set, the TV can only be controlled by the remote control. In this case the control panel buttons will not work. Hence, if one of those buttons is pressed, **Child Lock Is On** will be displayed on the screen when the menu screen is not visible.

**Set PIN:** Defines a new PIN number. Use numeric buttons to enter a new pin number. You will need to enter your new pin a second time for verification purposes.

**IMPORTANT:** The factory default pin number is **0000**, if you change the pin number make sure you write it down and keep it safe.

## Timers

To view *Timers* menu, press “**MENU**” button and select *Settings* icon by using “◀” or “▶” button. Press **OK** button to view *Settings* menu. Use “▼” or “▲” button to highlight *Timers* and press **OK** to continue:

### Setting Sleep Timer

This setting is used for setting the TV to turn off after a certain time.

- Highlight Sleep Timer by using “▼” or “▲” button.
- Use “◀” or “▶” button to set. The timer can be programmed between **Off** and **2.00** hours (120 minutes) in steps of 30 minutes.

### Setting Programme Timers

You can set programme timers for a particular programme using this feature.

Press “▼” button to set timers on an event. Programme timer function buttons will be displayed on the screen.

### Adding a Timer

- Press **YELLOW** button on the remote control to add a timer. The following menu appears on the screen:

**Channel:** Changes network type by using “◀” or “▶”.

**Timer Type:** This feature is unavailable to be set.

**Date:** Enter a date using the numeric buttons.

**Start:** Enter a starting time using the numeric buttons.

**End:** Enter an ending time using the numeric buttons.

**Duration:** Displays duration between the starting and ending time.

**Repeat:** Sets a timer to be repeated as Once, Daily or Weekly. Use “◀” or “▶” buttons to select an option.

- Press **GREEN** button to save the timer. Press **RED** button to cancel.

**Change/Delete:** Controls parental settings on timers.

### Editing a Timer

- Select the timer you want to edit by pressing “▼” or “▲” button.

- Press **GREEN** button. Edit Timer menu screen will be displayed.

- When finished with editing, press **GREEN** button to save. You can press "**MENU**" button to cancel.

### Deleting a Timer

- Select the timer you want to delete by pressing "▼" or "▲" button.
- Press **RED** button.
- Select **YES** by using "◀" or "▶" buttons to delete the timer. Select **NO** to cancel.

## Configuring Date/Time Settings

Select **Date/Time** in the Settings menu to configure Date/Time settings. Press **OK** button.

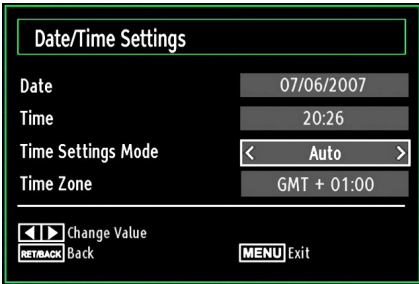

- Use "▼" or "▲" buttons to highlight **Date/Time**.

Date, Time, Time Settings Mode and Time Zone Setting will be available.

Use "▼" or "▲" buttons to highlight the Time Settings Mode. Time Settings Mode is set using "◀" or "▶" buttons. It can be set to AUTO or MANUAL.

When AUTO is selected, Date/Time and Time Zone options will not be available to be set. If MANUAL option is selected as the Time Zone can be altered:

- By pressing "▼" or "▲" buttons select Time Zone.

Use "◀" or "▶" buttons to change the Time Zone between GMT-12 or GMT+12. Date/Time on the top of the menu list will then change according to the selected Time Zone.

- Changes are automatically stored. Press "**MENU**" to exit.

## Configuring Source Settings

You can enable or disable selected source options. The TV will not switch to the disabled source options when "**SOURCE**" button is pressed.

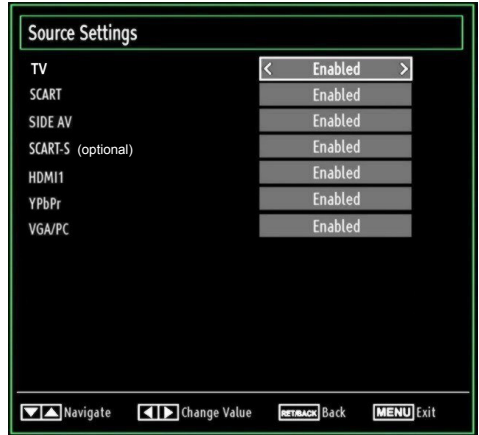

- Select **Sources** in the Settings menu and press **OK** button.

- Press "▼" or "▲" buttons to select a source.

- Use "◀" or "▶" button to enable or disable the selected source. Changes are automatically stored.

**Note:** YPbPr mode can be used only when you connect a device that has a YPbPr output through the PC input with YPbPr to PC cable (not supplied).

## Configuring Other Settings

To view general configuration preferences, select **Other Settings** in the Settings menu and press **OK** button.

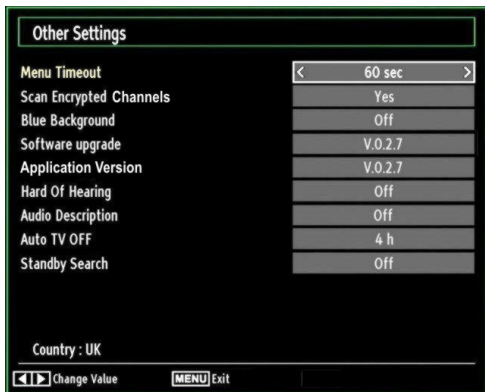

### Operation

- Press “▼” or “▲” buttons to select an item.
- Use “◀” or “▶” button to set an option.
- Press **OK** button to view a sub-menu.

**Menu Timeout:** Changes timeout duration for menu screens.

**Scan Encrypted Channels:** When this setting is on, search process will locate the encrypted channels as well. If it is set as **Off**, encrypted channels will not be located in automatic search or manual search.

**Blue Background (Optional):** Activates or deactivates blue background system when the signal is weak or absent.

**Software Upgrade:** To ensure that your TV always has the most update information, you can use this setting. In order for the proper operation, please ensure that the TV is set to standby mode.

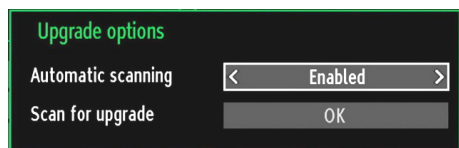

You can enable or disable automatic upgrade by setting **Automatic Scanning** option.

You can manually search for new software by selecting **Scan for upgrade**.

**Application version:** Displays the current application version.

**Hard of Hearing:** If the broadcaster enables any special signal concerning the audio, you can set this setting as On to receive such signals.

**Audio Description:** Audio description refers to an additional narration track for blind and visually impaired viewers of visual media, including television and movies. The description narrator talks through the presentation, describing what is happening on the screen during the natural pauses in the audio (and sometimes during dialogue, if deemed necessary). You can use this feature, only if the broadcaster supports that additional narration track.

**Auto TV Off:** You can set the timeout value of auto off feature. After the timeout value is reached and the TV is not operated for selected time, the TV will go off.

**Standby Search (optional):** Use “▼” or “▲” button to select Standby Search and then press “◀” or “▶” button to set this setting as On or Off. If you change Standby Search to Off, this function will be unavailable. To use Standby search please make sure that you select Standby Search as On.

## Other Features

**Displaying TV Information:** Programme Number, Programme Name, Sound Indicator, time, teletext, channel type and resolution information is displayed on the screen when a new programme is entered or “**INFO**” button is pressed.

**Mute Function:** Press “~~⊗~~” button to disable sound. Mute indicator will be displayed in the upper side of the screen. To cancel mute, there are two alternatives; the first one is pressing the “~~⊗~~” button and the second one is increasing the volume level.

**Picture Mode Selection:** By pressing **PRESETS** button, you can change **Picture Mode** settings in accordance with your viewing requirements. Available options are Dynamic, Natural, Cinema and Game.

**Displaying Subtitles:** You can enable subtitles by pressing the **SUBTITLE** button of the remote control. Press **SUBTITLE** button again to disable subtitle function.

If “Subtitle” is On, pressing the “” button causes the following warning message display on the screen (\*\* for UK only).

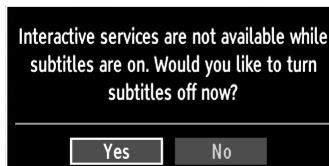

## Teletext

The teletext system transmits information such as news, sports and weather on your TV. Note that if the signal degrades, for example in poor/adverse weather conditions, some text errors may occur or the teletext mode may be aborted.

**Teletext function buttons** are listed below:

“” **Teletext / Mix:** Activates teletext mode when pressed once. Press again to place the teletext screen over the programme (mix). Pressing again will quit the teletext mode.

“**RETURN**” **Index:** Selects the teletext index page.

“**INFO**” **Reveal:** Shows hidden information (e.g. solutions of games).



“**OK**” **Hold:** Holds a text page when convenient. Press again to resume.

“/” **Subcode Pages:** Selects subcode pages if available when the teletext is activated.

**P+ or P- and numbers (0-9):** Press to select a page.

*Note: Most TV stations use code 100 for their index pages.*

### Coloured Buttons (RED/GREEN/YELLOW/BLUE)

Your TV supports both **FASTTEXT** and **TOP text** systems. When these systems are available, the pages are divided into groups or topics. When **FASTTEXT** system is available, sections in a teletext page will become colour-coded and can be selected by pressing the coloured buttons. Press a coloured button that corresponds to with your needs. The coloured writings will appear, showing you which coloured buttons to use when **TOP text** transmission is present. Pressing “” or “” commands will request the next or previous page respectively.

## Tips

**Screen Care:** Clean the screen with a slightly damp, soft cloth. Do not use abrasive solvents as they may damage the coating layer of the TV screen. For your safety, unplug the mains plug when cleaning the set. When moving the TV, hold it properly from the bottom of the unit.

**Image Persistence:** Please note that ghosting may occur while displaying a persistent image. On LED TVs' image persistence may disappear after a short time. Try turning the TV off for a while.

To avoid this, do not leave the screen in still picture for extended periods.

**No Power:** If your TV system has no power, please check the main power cable and connection to the mains socket outlet.

**Poor Picture:** Have you selected the correct TV system? Is your TV set or house aerial located too close to a non-earthed audio equipment or neon lights, etc.? Mountains or high buildings can cause double pictures or ghost images. Sometimes you can improve the picture quality by changing the direction of the aerial. Is the picture or teletext unrecognisable? Check if you have entered the correct frequency. Please retune the channels. The picture quality may degrade when two peripherals are connected to the TV at the same time. In such a case, disconnect one of the peripherals.

**No Picture:** Is the aerial connected properly? Are the plugs connected tightly to the aerial socket? Is the aerial cable damaged? Are suitable plugs used to connect the aerial? If you are in doubt, consult your dealer. No Picture means that your TV is not receiving a transmission. Have you selected the correct button on the remote control? Try once more. Also make sure the correct input source has been selected.

**Sound:** If you cannot hear any sound, check to see if the “” button has been pressed. If sound is coming from only one speaker, check if the audio balance has been set to one extreme.

**Remote Control:** Your TV no longer responds to the remote control. Perhaps the batteries are exhausted. If so you can still use the local buttons on the TV.

**Input Sources:** If you cannot select an input source, it is possible that no device is connected. Check the AV cables and connections if you have tried to connect a device.



## Appendix A: PC Input Typical Display Modes

The display has a maximum resolution of 1920 x 1200. The following table is an illustration of some of the typical video display modes. Your TV may not support different resolutions. Supported resolution modes are listed below. If you switch your PC to an unsupported mode, a warning OSD will appear on the screen.

Index	Resolution	Frequency
1	640x350	85 Hz
2	640x400	70 Hz
3	640x480	60Hz-66Hz-72Hz -75Hz-85Hz
4	800x600	56Hz-60Hz-70Hz-72Hz -75Hz-85Hz
5	832x624	75 Hz
6	1024x768	60Hz-66Hz-70Hz-72Hz -75Hz
7	1152x864	60Hz-70Hz-75Hz -85 Hz
8	1280x768	60 HzA
9	1280x768	60 HzB
10	1280x768	75Hz-85Hz
11	1280x960	60Hz-75Hz-85Hz
12	1280x1024	60Hz-75Hz-85Hz
13	1360x768	60 Hz
14	1400x1050	60 HzA
15	1400x1050	60 HzB
16	1400x1050	75Hz-85Hz
17	1400x900	65Hz-75Hz
18	1600x1200	60 Hz
19	1680x1050	60 Hz
20	1920x1080	60 HzA
21	1920x1080	60 HzB
22	1920x1200	60HzA
23	1920x1200	60Hz

## Appendix B: AV and HDMI Signal Compatibility (Input Signal Types)

Source	Supported Signals	Available	
EXT (SCART)	PAL 50/60	O	
	NTSC 60	O	
	RGB 50	O	
	RGB 60	O	
Side AV	PAL 50/60	O	
	NTSC 60	O	
YPbPr	480I	60Hz	O
	480P	60Hz	O
	576I	50Hz	O
	576P	50Hz	O
	720P	50Hz	O
	720P	60Hz	O
	1080I	50Hz	O
	1080I	60Hz	O
	1080P	50Hz	O
	1080P	60Hz	O
HDMI1	480I	60Hz	O
	480P	60Hz	O
	576I	50Hz	O
	576P	50Hz	O
	720P	50Hz	O
	720P	60Hz	O
	1080I	50Hz	O
	1080I	60Hz	O
	1080P	24Hz	O
	1080P	25Hz	O
	1080P	30Hz	O
	1080P	50Hz	O
1080P	60Hz	O	

(X: Not Available, O: Available)

*In some cases a signal on the LED TV may not be displayed properly. The problem may be an inconsistency with standards from the source equipment (DVD, Set-top box, etc. ). If you do experience such a problem please contact your dealer and also the manufacturer of the source equipment.*



## Appendix C: Supported DVI Resolutions

When connecting devices to your TV's connectors by using DVI to HDMI cables (not supplied), you can refer to the following resolution information.

Index	Resolution	Frequency
1	640x400	70Hz
2	640x480	60Hz-66Hz-72Hz-75Hz
3	800x600	56Hz-60Hz-70Hz-72Hz-75Hz
4	832x624	75 Hz
5	1024x768	60Hz-66Hz-70Hz-72Hz-75Hz
6	1152x864	60Hz-70Hz-75Hz
7	1152x870	75Hz
8	1280x768	60 Hz
9	1280x768	75Hz
10	1280x960	60Hz-75Hz
11	1280x1024	60Hz-75Hz
12	1360x768	60 Hz
13	1400x1050	60 Hz
14	1400x1050	75Hz
15	1400x900	65Hz-75Hz
16	1600x1200	60 Hz
17	1680x1050	60 Hz
18	1920x1080	60 Hz
19	480i-480p	60Hz
20	576i-576p	50Hz

## Appendix D: Software Upgrade

- Your TV is capable of finding and updating new software upgrades over broadcast channels.
- For broadcast channels search, the TV looks at the available channels stored in your settings. So before the software upgrade search, it is advised to auto search and update all available channels.

### 1) Software upgrade search via user interface

- It is possible to manually to check if there is a new software upgrade for your TV set.
- Simply navigate on your main menu. Choose Settings and select Other Settings menu. In Other Settings menu navigate on to the Software Upgrade item and press **OK** button to open Upgrade Options menu.
- In Upgrade Options menu select Scan for upgrade and press **OK** button.
- If a new upgrade is found, it starts to download the upgrade. A progress bar indicates the remaining download progress. When the download completes successfully a message is displayed for reboot to activate new software. Press **OK** to continue with the reboot operation.

### 2) 3.AM search and upgrade mode

- If Automatic scanning in Upgrade Options menu is enabled, the TV wakes up at 03:00 and searches the broadcast channels for new software upgrade. If new software is found and downloaded successfully, with the next power up the TV opens with new software version.

*Note on reboot operation: Reboot is the last step in software upgrade operation if download of new software is finished successfully. During reboot TV makes final initializations. In the reboot sequence panel power is closed and front led indicates the activity with blinking. Around 5 minutes later TV restarts with new software activated.*

- If your TV fails to restart in 10 minutes, unplug power for 10 minutes and re-plug again. TV should open with new software safely. If you still can not get TV working, please kindly repeat unplug and plug sequence a few times more. If your set still can not operate, please call the service personnel to fix the problem for you.

*Caution: While the LED is blinking during reboot do not unplug your TV's power. Doing this may cause your TV not to re-start again and can only be fixed by service personnel.*

## Appendix E : Supported File Formats for USB Mode

Media	File Extension	Format		Remarks
		Video	Audio	(Maximum resolution/Bit rate etc.)
Movie	.mpg, .mpeg	MPEG1, 2	MPEG Layer 1/2/3	MAX 1920x1080 @ 30P 20Mbit/sec
	.dat	MPEG1, 2	MPEG2	
	.vob	MPEG2		
	.avi	MPEG2	PCM/MP3	MAX 1920x1080 @ 30P 20Mbit/sec
	Xvid 1.00, Xvid 1.01, Xvid 1.02, Xvid 1.03, Xvid 1.10-beta1/2	PCM		
Music	.mp3	-	MPEG 1 Layer 1 / 2 (MP3)	32Kbps ~ 320Kbps(Bit rate) 32KHz ~ 48KHz(Sampling rate)
Photo	.jpg .jpeg	Baseline JPEG		max WxH = 15360x8640 4147200bytes
		Progressive JPEG		max WxH = 1024x768 6291456bytes
	.bmp	-		max WxH = 9600x6400 3840000bytes
Subtitle	.sub	-		-
	.srt	-		



**Products**



**Battery**

### Information for Users on Disposal of old Equipment and Batteries

[European Union only]

These symbols indicate that equipment with these symbols should not be disposed of as general household waste. If you want to dispose of the product or battery, please consider the collection systems or facilities for appropriate recycling.

**Notice:** The sign Pb below the symbol for batteries indicates that this battery contains lead.

## Specifications

### TV BROADCASTING

PAL/SECAM B/G D/K K' I/I' L/L'

### RECEIVING CHANNELS

VHF (BAND I/III)

UHF (BAND U)

HYPERBAND

### NUMBER OF PRESET CHANNELS

1000

### CHANNEL INDICATOR

On Screen Display

### RF AERIAL INPUT

75 Ohm (unbalanced)

### OPERATING VOLTAGE

220-240V AC, 50 Hz.

### AUDIO

German + Nicam Stereo

### AUDIO OUTPUT POWER ( $W_{RMS}$ ) (10% THD)

2 x 6

### POWER CONSUMPTION (W)

65 W (max)

### PANEL

16:9 display, 26" Screen Size

### DIMENSIONS (mm)

DxLxH (With foot): 188 x 649 x 453

Weight (Kg): 6,25

DxLxH (Without foot): 39,5 x 649 x 412

Weight (Kg): 5,85

<b>Digital Reception</b> <b>DVB-T</b>	MHEG-5 ENGINE compliant with ISO/IEC 13522-5 UK engine Profile 1	for UK
	Object carousel support compliant with ISO/IEC 135818-6 and UK DTT profile	
	Frequency range: 474-850 MHz for UK models	
	170-862 MHz for EU models	
	Transmission standard: DVB-T. MPEG-2	
	Demodulation: COFDM with 2K/8K FFT mode	
	FEC: all DVB modes	
	Video: MP@ML, PAL, 4:3/16:9	
	Audio: MPEG Layer I&II 32/44.148kHz.	