

# AKAI

## 7" Portable DVD player

ACVDS735



User manual  
Gebruiksaanwijzing  
Manuel de l'utilisateur

GB 2

NL 24

FR 47

## Table of contents

<b>1.</b>	<b>Safety</b> .....	<b>3</b>
	1.1 Intended use .....	3
	1.2 Labels in this manual .....	3
	1.3 General safety instructions .....	4
<b>2.</b>	<b>Preparations for use</b> .....	<b>4</b>
	2.1 Unpacking .....	4
	2.2 Package contents .....	5
<b>3.</b>	<b>Installation</b> .....	<b>5</b>
	3.1 Connecting the units .....	6
	3.2 Support strap .....	6
	3.3 Connecting to a power source .....	7
	3.4 Game pad .....	7
	3.5 Remote control .....	8
<b>4.</b>	<b>Functions</b> .....	<b>9</b>
	4.1 Master unit .....	9
	4.2 Slave unit .....	10
	4.3 Game pad .....	10
	4.4 Remote control .....	11
<b>5.</b>	<b>Operation</b> .....	<b>12</b>
	5.1 Master power switch .....	12
	5.2 Quick start .....	12
	5.3 DVD/CD functions .....	14
	5.4 Game functions .....	16
	5.5 DVD setup menu operation .....	17
	5.6 Slave setup menu operation .....	18
<b>6.</b>	<b>Cleaning and maintenance</b> .....	<b>18</b>
	6.1 Handle and care of a disc .....	19
<b>7.</b>	<b>Troubleshooting</b> .....	<b>19</b>
<b>8.</b>	<b>Technical data</b> .....	<b>21</b>
<b>9.</b>	<b>Disposal of used electrical and electronic equipment</b> .....	<b>23</b>

## Copyright notice

Design and specifications are subject to change without notice.

# 1. Safety

## 1.1 Intended use

The LCD display with built-in DVD player plays film and photos from DVD, USB and memory card. The game pad can be connected to play video games. The appliance also plays music from CD. Read the manual carefully before first use.



DVDs and DVD appliances are manufactured under the worldwide agreed DVD regional code system that the appliance will operate only with corresponding disc of the same regional code. If the code number on the label of a DVD does not match that on the label alongside, the DVD will not play on this appliance.



The appliance has built-in copyright protection technology that prevents copying from a disc to any media. If a video recorder is connected to the appliance, the video output image will be distorted during recording.



Due to the great variety of products with external memory connection (USB, SD/MMC, etc.) and their sometimes quite manufacturer-specific functions we can neither guarantee that all devices will be recognised, nor that all operating options that are possible in theory will actually work.

## 1.2 Labels in this manual



### WARNING

A warning means that injury or death is possible if the instructions are not obeyed.



### CAUTION

A caution means that damage to the equipment is possible.



A note gives additional information, e.g. for a procedure.

## 1.3 General safety instructions



### WARNING

Do not put force on the appliance. The appliance can fall and can cause serious injury.



### CAUTION

Do not spill any liquid on the appliance.



### WARNING

Do not insert any objects in the ventilation holes.



### CAUTION

Do not block the ventilation holes.



This appliance is double insulated; therefore no earth wire is required. Always check that the mains voltage corresponds to the voltage on the rating plate. Never attempt to replace the adaptor plug with a regular mains plug.



This appliance employs a laser system. To prevent direct exposure to the laser beam, do not open the appliance.  
Visible laser radiation when open and interlock defeated.

## 2. Preparations for use

### 2.1 Unpacking

- Unpack the appliance carefully.
- Check the package contents as described below. If any item is missing, please contact your reseller.
- Remove the labels from the front panel carefully if present.



We recommend that you retain the original carton and packing materials in case it ever becomes necessary to return your product for service. This is the only way to safely protect the product against damage in transit. If you do dispose of the carton and the packing materials, please remember to recycle with due care to the environment.

## 2.2 Package contents

The following items are included in the received package:

- 1 LCD display with built-in DVD player (master unit)
- 1 LCD display (slave unit)
- 1 Unit connection cable
- 1 Game pad
- 1 Remote control
- 1 Battery (CR2025)
- 1 Support strap
- 1 Carrying bag
- 1 Operator manual



If any item is missing, please contact your reseller.

## 3. Installation

- Install the batteries in the remote control.  
Read the paragraph "Remote control".
- If required, install the batteries in the game pad.  
Read the paragraph "Game pad".
- Connect the two units to each other.  
Read the paragraph "Connecting the units".
- Attach the unit to the head rest in the car.  
Read the paragraph "Support strap".
- Connect the master unit to a power source.  
Read the paragraph "Connecting to a power source".



## CAUTION

- Do not put the appliance near a heat source.
- Do not expose the appliance to direct sunlight.

## 3.1 Connecting the units

- Connect the adaptor plugs of the connection cable to the DC OUT 9-12 V connection and to the AV OUT connection in the master unit.
- Connect the other ends of the connection cable to the DC IN 9-12 V connection and to the AV IN connection in the slave unit.

## 3.2 Support strap

- Secure the rear of the unit to the support strap.

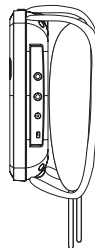
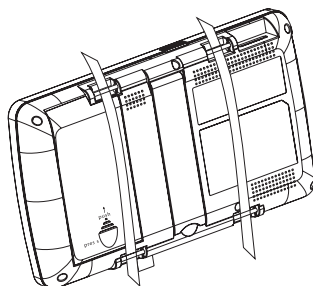

### 3.3 Connecting to a power source

#### Connecting to a car battery

For this connection the 12 V<sub>DC</sub> adaptor + cable has to be used.

- Connect the adaptor plug of the adaptor cable to the DC IN 9-12 V connection in the master unit.
- Connect the DC plug to 12 V<sub>DC</sub> receptacle of the vehicle.

#### Connecting to the mains

For this connection the AC/DC adaptor + cable has to be used. The AC/DC adaptor + cable is not supplied with the appliance.

- Connect the adaptor plug of the adaptor cable to the DC IN 9-12 V connection in the master unit.
- Connect the mains plug to a wall socket.

### 3.4 Game pad

#### Installing the batteries

The batteries for the game pad are not supplied with the appliance.

- Remove the battery cover.
- Insert the batteries matching the (+) and (-) polarity markings.
- Re-install the battery cover.

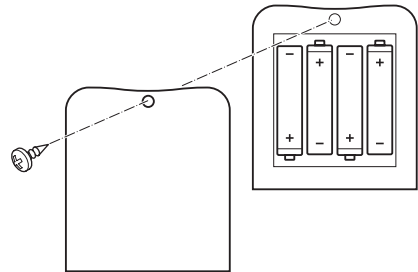

#### CAUTION

Incorrect installation can cause battery leakage and corrosion which will damage the appliance. Corrosion, oxidation, battery leakage and any other gradually acidic defect of this nature will invalidate the guarantee.

## 3.5 Remote control

### Installing the battery

- Press the catch and at the same time pull out the battery tray.
- Insert 1 lithium battery, type battery with the stamped (+) mark facing upward.
- Insert the battery tray into the remote control.

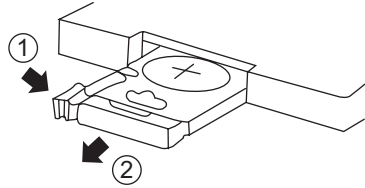

#### CAUTION

Incorrect installation can cause battery leakage and corrosion which will damage the appliance. Corrosion, oxidation, battery leakage and any other gradually acidic defect of this nature will invalidate the guarantee.



## 4. Functions

### 4.1 Master unit

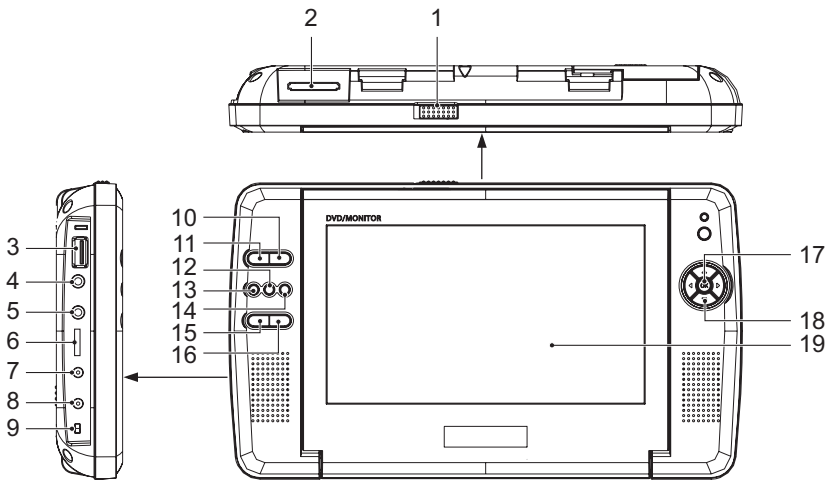

- |   |                          |    |                   |
|---|--------------------------|----|-------------------|
| 1 | OPEN button              | 10 | MUTE button       |
| 2 | SD/MS/MMC card slot      | 11 | SOURCE button     |
| 3 | USB slot                 | 12 | PLAY/PAUSE button |
| 4 | AV OUT connection        | 13 | SETUP button      |
| 5 | Headphone jack           | 14 | STOP button       |
| 6 | VOLUME dial              | 15 | MENU button       |
| 7 | DC OUT 9-12 V connection | 16 | TITLE button      |
| 8 | DC IN 9-12 V connection  | 17 | ENTER button      |
| 9 | Master power switch      | 18 | Arrow buttons     |
|   |                          | 19 | LCD display       |

## 4.2 Slave unit

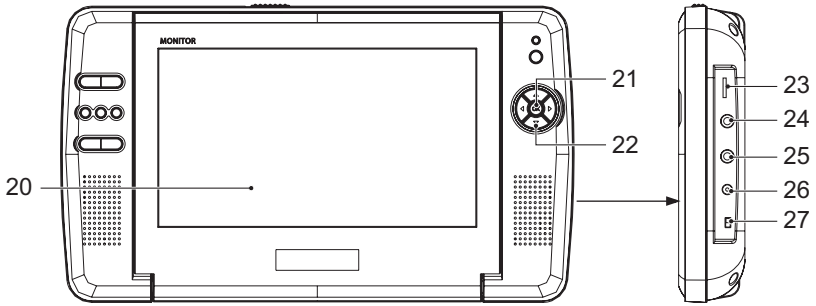

- 20 LCD display
- 21 MODE button
- 22 Arrow buttons
- 23 VOLUME dial
- 24 Headphone jack
- 25 AV IN connection
- 26 DC IN 9-12 V connection
- 27 Master power switch

## 4.3 Game pad

- 28 Joystick
- 29 Direct pad
- 30 SELECT button
- 31 Power switch
- 32 START button
- 33 A button
- 34 B button
- 35 X button
- 36 Y button
- 37 RESET button

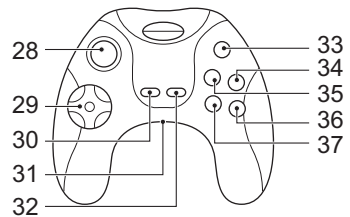

## 4.4 Remote control

- 38 OSD button
- 39 SEARCH button
- 40 Digit buttons (0-10+)
- 41 SUBTITLE button
- 42 ANGLE button
- 43 TITLE button
- 44 Arrow buttons
- 45 ENTER button
- 46 SETUP button
- 47 REPEAT button
- 48 AB button
- 49 PROGRAM button
- 50 DISPLAY button
- 51 REV button
- 52 FWD button
- 53 PREV button
- 54 NEXT button
- 55 ZOOM button
- 56 MENU button
- 57 SLOW button
- 58 STOP button
- 59 PLAY/PAUSE button
- 60 AUDIO button
- 61 PBC button
- 62 STEP button
- 63 MUTE button
- 64 SOURCE button

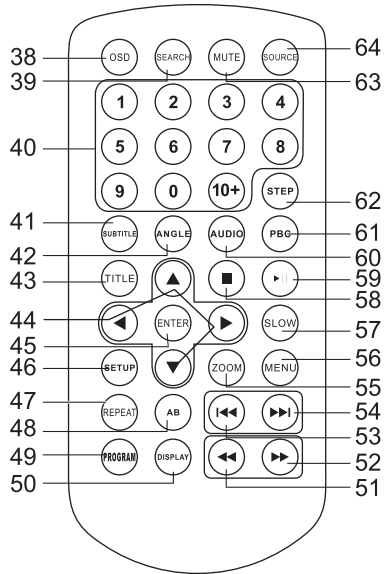

The arrow buttons are buttons for navigation in the DVD menu.

## 5. Operation

All functions of the unit are accessible using the remote control.  
All instructions refer to operation with the remote control, unless indicated otherwise.

### 5.1 Master power switch

The units are equipped with a master power switch (9 & 27) located at the side panel.

- Set the switch into the ON position prior to taking the units into operation.
- Set the switch into the OFF position prior to disconnecting from the mains.



- The units are designed to be operated using the remote control.

### 5.2 Quick start

#### General functions

- To connect the master unit with the slave unit, proceed as follows:
  - Connect the adaptor plugs of the connection cable to the DC OUT 9-12 V connection and to the AV OUT connection in the master unit.
  - Connect the other ends of the connection cable to the DC IN 9-12 V connection and to the AV IN connection in the slave unit.
- To select the source mode (DVD/CARD/USB), press the SOURCE button (64).
- To adjust the volume, turn the VOLUME dial (6 & 23) until the desired level is set..
- To mute or restore sound, press the MUTE button (63).
- To connect a headphone, insert the cable plug in the headphone jack (6 & 24). To prevent hearing damage, remember to adjust the volume to a comfortable level.

## DVD/CD functions

- Switch on the units. Select the DVD mode.
- To insert a disc:
  - Press the OPEN button (1) to open the disc compartment.
  - Insert the disc with the label upwards.
  - Close the disc compartment.

The display shows the total number of tracks on the CD.

- To start playback, press the PLAY/PAUSE button (59) once.
- For extended instructions, read the paragraph "DVD/CD functions" further on in this manual.

## USB functions

- Switch on the master unit.
- Insert the USB device in the slot (3). The device can only be connected one way.
- Select the USB mode.
- To start playback, press the PLAY/PAUSE button (59) once.
- For extended instructions, read the paragraph "USB functions" further on in this manual.

## SD/MS/MMC functions

- Switch on the master unit.
- Insert the SD/MS/MMC device in the slot (2). The device can only be connected one way.
- Select the memory card mode.
- To start playback, press the PLAY/PAUSE button (59) once.

## Game functions

- Before connecting the game pad, make sure that the game pad is switched off before connecting to the appliance.
- Connect the RCA cable to the appliance.
  - The yellow plug is for the video signal.
  - The red and white plug are for the audio signal.
- Switch on the appliance.
- Slide the power switch (31) to the ON position.

## 5.3 DVD/CD functions

After the disc has been loaded, the disc starts automatically

- Press the arrow buttons (44) to select a menu item for DVDs.
- Press the ENTER button (45) to enter the selected menu item.

During playback, the following functions are available:

- To select a chapter (DVD) or track (CD), press the digit buttons (40).
- To select the next or previous chapter (DVD) or track (CD), press the PREV button (53) or the NEXT button (54).
- To forward or rewind the DVD, press the FWD button (52) or the REV button (51). The available speed rates are: 2x, 4x, 8x, 16x, 32x.
- To pause playback, press the PLAY/PAUSE button (59) once; to resume playback, press the button again.
- To stop playback temporarily, press the STOP button (58) once. Press the button again to stop playback permanently, or press the PLAY/PAUSE button (59) to resume playback.
- To repeat a chapter (DVD) or one or all tracks (CD):
  - Press the REPEAT button (47) once to repeat the current chapter or track.
  - Press the button once again to repeat the current title.
  - Press the button once again to repeat all titles.
  - Press the button once again to cancel the function.
- To view a specific title of a DVD, press the TITLE button (43). Use the arrow buttons to select the title.
- To select the audio language of a DVD, press the AUDIO button (60) repeatedly until the desired language is set.
- To switch on the subtitles of a DVD, press the SUBTITLE button (41). Press the button again to switch off the subtitles.
- To select extra information of a DVD or CD (remaining time/played playtime/track number/chapter number), press the DISPLAY button (50).
- To select the camera angle, press the ANGLE button (42).
- To show the menu of available titles, press the TITLE button (43).
- To return to the main menu, press the MENU button (56).
- Press the DISPLAY button (50) to change the display settings.



- Normally, if an MP3 disc is loaded, the unit will take longer time to read the initial data.
- A DVD that does not match the region code cannot be read by the unit.

- If a disc contains mixed content (e.g. MP3 and video files), the unit will only recognise, list and play one content type.
- The screen saver becomes active if no disc has been loaded for 3 minutes, or if the unit has been in STOP mode for 3 minutes.

### Using the SEARCH function

The SEARCH function can be used to select a specific starting point on a DVD or CD.

- Press the SEARCH button (39).
- Press the digit buttons (40) to select an entry.

The possible entries for DVD are:

- Disc time
- Chapter
- Title
- Chapter time
- Title time

The possible entries for CD are:

- Track time
- Specific track
- Press the digit buttons to set a selection.

### Using the PROGRAM function

- Press the PROGRAM button (49) to enter the PROGRAM function.
- Press the digit buttons (43) to select a desired track, and use the arrow button down (44) to highlight the next entry.
- To confirm the selection and start the program, move the highlight to "START" and press the ENTER button (45).
- To stop the program, press the PROGRAM button (49) and press ENTER.

### Using the ZOOM function

This function can be used for zooming in and out on photos and DVDs.

The available zoom ratios are: 2x, 3x, 4x, 1/2x, 1/3x, 1/4x.

- Press the ZOOM button (55).
- Press the ZOOM button again to set the correct size.
- Press the arrow buttons to move through the picture.

### Using the MP3/WMA/MPEG4 playback function

- Insert an MP3/WMA/MPEG4 disc. A content menu will display on the TV screen.

- Press the up/down arrow buttons (44) to select a folder or a file.
- Press the ENTER button (45) to enter the selected folder or file.
- Press the PROGRAM button (49) to switch between folders and files. Press ENTER (45) to confirm.

### **Using the JPEG playback function**

- Insert a JPEG disc. A content menu will display on the TV screen.
- Press the up/down arrow buttons (47) to select a folder or a file. Press the ENTER button (45) to start the slide show.
- Press the PLAY/PAUSE button (59) to hold the slide show at the current picture.
- Press the PLAY/PAUSE button (59) to resume the slide show.
- Press the PREV button (53) or the NEXT button (54) to select the previous or next picture.
- To magnify the picture, press the ZOOM button (55). To zoom in or out on the picture, press the FastForward button (52) or FastRewind button (51). To move the picture, press the arrow buttons (44).

### **Using the Video CD playback function**

- Press the PBC button (61) to switch on the playback function.
- Insert a Video CD.
- To start playback, press the PLAY/PAUSE button (59) once.
- To select the audio channel during Video CD playback, press the AUDIO button (60).
- Press the PBC button (61) to quit the playback and return to the main menu.

## **5.4 Game functions**

After having connected the game pad, a menu screen appears on the display.

- Select a game from the menu. Scroll up or down with the joystick (28).
- Press the START button (32) to confirm.
- If you want to change game, press the RESET button (37) and select a new game from the menu.
- When you are finished, slide the power switch (31) to the OFF position and disconnect the RCA cable.



## 5.5 DVD setup menu operation



This menu only works in DVD mode.

### To change the initial settings

The following actions have to be carried out with the remote control.

- Press the SETUP button (46).
- Press the arrow buttons (left and right) (44) to select a menu.  
The submenu is displayed directly.
- Press the arrow buttons (up and down) to enter the submenu.
- Press the ENTER button (45) to select a setting, or the left arrow button to cancel the selection. If the selection invokes a subsequent submenu, repeat the previous steps to select a setting.
- Press the ENTER button (45) to store the setting.
- Press the SETUP button (46) to exit.

### System setup page

- TV SYSTEM: to set the colour system. The following settings are available: NTSC, PAL, AUTO.
- SCREEN SAVER: to activate the screen saver.
- TV TYPE: to set the aspect ratio. The following settings are available: 4:3 PANSCAN, 4:3 LETTERBOX, 16:9.
- PASSWORD: to set the password. The default password (0000) is always active, even if the password has been reset.
- RATING: to set a rating for movies played by the unit. Movies rated higher than the level set for the parental lock can not be viewed. This function is only available with discs that have parental rating encoded.
- DEFAULT: Restore all default settings of the unit.

### Language setup page

- OSD LANGUAGE: to change the language. The following settings are available: English, Dutch, French, German, Greek, Spanish.
- AUDIO: to set the audio language.
- SUBTITLE: to set the subtitle language.
- MENU LANGUAGE: to set the language for the disc menu.
- FONT SETUP: to set the font.

## Video setup page

- BRIGHTNESS: to adjust the screen brightness.
- CONTRAST: to adjust the screen contrast.
- HUE: to adjust the screen tint. This option is available for NTSC playback only.
- SATURATION: to adjust the saturation.

## Speak setup page

### Downmix

- Select LT/RT to mix 5.1-channel audio into left channel and right channel.
- Select STEREO to mix 5.1 channel audio into signal stereo.

## 5.6 Slave setup menu operation

- Press the MODE button (21) to enter the slave setup menu.

### Picture

- BRIGHT to set the brightness of the picture.
- CONTRAST to set the contrast of the picture.
- COLOR to set the colour of the picture.
- LANGUAGE to set the language of the country.
- RESET to restore the default settings.

### Option

- NORMAL to rotate the picture upside down.
- SCREEN to set the aspect ratio.

## 6. Cleaning and maintenance



### WARNING

Before performing any cleaning or maintenance, switch off and unplug the appliance.

- Clean the outside of the appliance with a soft cloth. When the appliance is very dirty, dampen the cloth slightly with water and a neutral solution.

## 6.1 Handle and care of a disc

- Hold the disc with fingers. Hold the disc outer edge and/or the centre spindle hole. Do not touch the disc surface.
- Do not bend or press the disc. Do not expose the disc to direct sunlight or heating sources.
- Clean the disc surface with a soft, dry cleaning cloth. Wipe the disc surface gently, radially, from centre towards the outer edge.
- Do not apply thinner, alcohol, chemical solvent, or sprays when cleaning. Such cleaning fluids will permanently damage the disc surface.

## 7. Troubleshooting

Trouble	Action
No sound or incomplete audio	Check if the random equipment are switched on and set correctly. Check cables for connection problems. Check if the correct source is selected. Check volume or mute setting.
No power	Check if the power cord has been properly connected to the power outlet. Check if the master power switch on the side panel is ON.
Malfunction	Should the unit develop a serious malfunction, unplug the unit for 30 minutes. After this, power on the unit and restore to factory default.

### DVD/VCD/CD

Trouble	Action
No playback	There is no disc inserted. Load a disc in the master unit. Disc is loaded upside down. Place the disc with the label facing upward. Rating level of the disc is higher than the rating level setting of the unit. Invalid region code. Incorrect type of disc.

	Disc may be damaged or dirty, clean the disc or try another disc. Moisture may have condensed inside the unit. Remove the disc and leave the unit powered on for one or two hours.
No sound or incomplete audio	Select another audio track. During SCAN, SLOW MOTION or SINGLE STEP the sound is muted. Check if the disc is in fast forward or fast rewind mode. Press the PLAY/PAUSE button (59).
No scan or skip possible	Some discs are programmed to refuse user action at certain sections. This is no malfunction. Single chapter or track discs do not allow skip function.
Picture distorted or noisy	Disc may be damaged or dirty, clean the disc or try another disc. Check TV system setting (PAL/NTSC). Clean the disc.
Picture not full screen	Select the screen format from the unit's setup menu. Select screen format in disc start menu.

## MP3 playback

Trouble	Action
No sound or incomplete audio	If MP3 data is mixed with other files on CD, the appliance may play the non-MP3 files as noise or without sound or it rejects the disc. Check if the played file is in MP3 format or select another file to play.

## USB playback

Trouble	Action
No playback	USB device is not installed or installed incorrectly. Insert USB device into slot. Incompatible USB device used. Playback using any USB device cannot be guaranteed. Please try another USB device.

## Remote control (RC)

Trouble	Action
RC does not function	Check the battery installation. Point the RC at the remote control sensor. Stay within 8 metres of the appliance.

# 8. Technical data

## DVD player

Parameter	Value
Voltage	9-12 V <sub>DC</sub>
Input voltage	100 ~ 240 V <sub>AC</sub> / 50 ~ 60 Hz
Power consumption	< 15 W
Max. power output	2 x 1.5 W
USB connection	USB 2.0 compatible
Flash memory connection	SD/MS/MMC
Dimensions (W x H x D)	248 x 142 x 37 mm
Weight	1400 g

## Disc output

Parameter	Value
Laser type	Semiconductor
Signal/noise ratio	> 80 dB
Wow and flutter	Below the limit of the unit
Audio dynamic range	> 85 dB
Frequency response	20 Hz - 20 kHz (1 dB)
TV system	PAL/NTSC
Region code	2

## Output Terminals

Parameter	Value
Headphones output impedance	32 Ω
Analog video	1 Vp-p (75 Ω)
Analog audio	1.4 Vrms (1 KHz, 0 dB)

## Game pad

Parameter	Value
Power consumption	4x 1.5 V
Battery size	CR2025

## Remote control

Parameter	Value
Power consumption	2x 1.5 V
Battery size	CR2025

## Supported media formats

Parameter	Value
Disc types	DVD / DVD+R(W) / DVD-R(W) / (S)VCD / CD / CD-R(W)
Picture formats	JPEG / Kodak Picture CD
Video formats	MPEG1, MPEG2, MPEG4, WMA, AVI, Xvid
Audio formats	MPEG1 Layer I, II, III PCM Dolby Digital, MP3

## Working environment

Parameter	Value
Operating temperature	0 - 45 °C
Relative humidity	5% - 90%

## 9. Disposal of used electrical and electronic equipment



The meaning of the symbol on the material, its accessory or packaging indicates that this product shall not be treated as household waste. Please, dispose of this equipment at your applicable collection point for the recycling of electrical and electronic equipments waste. In the European Union and Other European countries which there are separate collection systems for used electrical and electronic product. By ensuring the correct disposal of this product, you will help prevent potentially hazardous to the environment and to human health, which could otherwise be caused by unsuitable waste handling of this product. The recycling of materials will help conserve natural resources. Please do not therefore dispose of your old electrical and electronic equipment with your household waste.

For more detailed information about recycling of this product, please contact your local city office, your household waste disposal service or the shop where you purchased the product.

For more information and warranty conditions, please visit: [www.akai.eu](http://www.akai.eu)